

Distribution

- [Common Terms in Distribution](#)
- [Overview](#)
 - [Definition](#)
 - [Distribution Modalities](#)
 - [Distribution Methodologies](#)
 - [Types of Distributions](#)
 - [Distribution Systems](#)
- [Main Types of In-Kind Commodities](#)
 - [Food](#)
 - [Non-Food Items](#)
- [Planning](#)
 - [Figures](#)
 - [Distribution Plan](#)
- [Process](#)
 - [Setting Up the Distribution / Before Distribution](#)
 - [Day of Distribution Operations](#)
 - [Closure / After Distribution](#)
- [Key Actors](#)
- [Protection Considerations](#)
- [Sites and Resources](#)
- [References](#)

Common Terms in Distribution

NFI	Short for Non-Food Items: Any non-food article, tool, utensil or other item which contributes to the physical and/or psychological health of populations.
PSN	Short for People with Specific Needs: People that we can expect could have special needs are particularly older people, small children, those with impaired mobility or breastfeeding mothers among others that could require any other special assistance or at risk.
Kit	A set of items used for a particular purpose or activity, generally packaged and/or distributed together.
Commodity	A term applied to food and non-food items given in mass distribution.
HF	Short for "Heads of Family", defined as a member of a household that represents it.
Household	A social unit composed of individuals, with genetic or social relations among themselves, under one head or leader, living under the same roof, eating from the same pot and sharing a common resource base.
EDP	Short for "Extended Delivery Point".
IDPs	Short for Internal Displaced Population.

Overview

Definition

A distribution is the hand-over of commodities to intended beneficiaries, fairly and according to specified rations, selection criteria and priorities. A distribution is the process during which control over the commodity passes from the organisation holding the stock to the intended beneficiary^[1].

The objective of every distribution is to mitigate the impact on individuals after or during a crisis by providing the means to preserve their health and ensure their welfare, safety and dignity.

Physical distribution is the final step of a product before reaching the final user, however the process depends entirely on previous activities. This might include decisions about what to procure and how much, transportation, storage and even packaging. It is essential to know as much detail as possible on how any given distribution is going to run to anticipate the possible constraints and challenges and establish corrective measures to mitigate them.

For the purposes of this guide the term distribution does NOT include the process by which commodities are procured, nor the process of transportation, storage and handling, though these are often in some way connected to the distribution process. This guide refers to the physical distribution of commodities at the final handover point.

Principles

Although every distribution should vary according to the context and local specifics, there are certain principles that apply to all distributions.

- All distribution should be fair, equitable, regular, accountable, and transparent. Beneficiaries should know the rations they are entitled to, the method of distribution, and the distribution schedule. The more transparent the system, the fewer the opportunities for abuse leading to unfair distribution practices. Those who distribute should be accountable to the beneficiaries as well as to the donors.
- All distributions involve coordination, logistics, monitoring, and reporting, which are carried out by a range of **actors**; including the government, UN agencies, NGOs, local partners and the beneficiaries. Good management therefore requires appropriate allocation of responsibilities between the different actors, and authority and decision-making must be clearly defined.
- A single controlling authority should be responsible for policy matters, determining overall priorities. Mechanisms for information exchange and coordination between all actors must be well planned. Coordination committees composed of all major actors are necessary both at national level for policy and planning, and in major operational areas for operational decisions.
- There are common elements in the implementation, which include the estimation of beneficiary numbers, selecting the type of recipients, type of beneficiary documents, determining the physical organisation of food distribution, as well as monitoring.
- Information on the beneficiary population is essential for designing a distribution system. No distribution can start without an estimate of the size of the population. The size of the population also influences the choice of recipient and the physical organisation of the distribution, such as the number of distribution points. Knowledge of the sociopolitical context is crucial in deciding **who manages** the distribution, or **who should be the recipient** of aid, and whether registration by beneficiaries is adequate.
- Beneficiary participation should be encouraged, which can be especially varied depending on if the community manages the entire program or parts of it. **Committees** are often recommended to provide a forum for discussion or information on the distribution.
- Access and protection matters must be considered at every stage of the distribution process, from the design of the intervention to the actual handover to beneficiaries, allocating resources and means to these matters. They should be part of the evaluation and reports.

Distribution Modalities

When assisting an affected population, delivery of physical goods is not the only possible response. Based on needs, different transfer modalities can be used:

In-kind - Beneficiaries receive the goods directly in the form of end products such as **kits and rations**.

Cash/Voucher - Beneficiaries receive a convertible value unit which can be used to acquire the necessary goods.

Cash/ Voucher interventions have unique considerations to be taken into account that are not the purpose of this guide. Information about Cash and Voucher Assistance (CVA) can be found through [The Cash Learning Partnership \(CaLP\)](#) network.

Distribution Methodologies

Generally speaking there are three different methodologies for managing distribution, and while each share the same ultimate goal they have different approaches, methods and objectives. This guide can be used by all the possible actors involved in a distribution, but it is assumed that distribution will be managed by an agency or one of its partners.

Government-Managed Distribution

The government may at different levels be the receiver and distributor of goods, using or coordinating with public distribution systems. For agencies involved in distribution, "*maximum use should be made of existing organisations and structures within the affected localities, with adaptations and redeployment as necessary*" (WFP, 1991). Government intervention frequently involves mechanisms for ensuring price stabilisation, such as sale of food through public distribution systems or subsidised NFI sales through fair price shops. Sale of commodities may be preferential to large-scale free distribution which usually is distributed to selected vulnerable groups through schools, social welfare, clinics, or other common coordination mechanisms.

The extent of government involvement in relief operations varies considerably from one emergency situation to another. Whereas in some countries the emergency response could be entirely in the hands of the government, other governments with lower capacity may be less or completely not involved.

Community-Managed Distribution

A variety of distribution methods have been termed "community-managed distribution". In some cases of community-managed distribution all aspects of the distribution process are managed by the community, whereas in others the community only manages part of the program.

- In entirely community managed programs, traditional leaders register beneficiaries and distribute items to families according to their perception of need.
- In partly community managed programs, community representatives manage one aspect of the program or participate through committees. For example, an agency may register beneficiaries and monitor, whilst the community distributes. Alternatively, community representatives may register beneficiaries and an aid agency distributes. In both cases, committees may participate in planning and monitoring the distribution.

Agency-Managed Distribution

An agency-managed distribution process entails commodity distribution direct to families or individuals by an agency or a trusted partner organisation. Agency-managed distribution requires registration of beneficiary families, sometimes limited to beneficiary lists, but often linked with the issuing of ration cards. A family member may need to present a ration card, ID or some other form of biometric information, and collect the distributed item. The item is usually, measured, weighed or counted by agency staff to match the entitlement and distribution plan.

Many variations on agency-managed distribution systems are possible. A compromise between what is ideal and what is possible may have to be made if no registration is possible.

Types of Distributions

The context of each distribution informs decisions on the types of distribution that best reach the desired objectives. The contextual factors include the geographic and cultural factors, the type of emergency, the vulnerabilities present in the population, and the nature of the distributed items.

By Set Up	Mobile Distribution	Portable distribution setups usually assembled out of vehicles to assist in multiple locations or areas without a permanent location. <i>Example: Open areas designed with ropes, trucks.</i>
	Fixed Distribution	Permanent or Semi-permanent distribution locations where basic infrastructure will be available for distributions. <i>Examples: MSUs, Community Centres.</i>
By Commodity Type	Recurrent Distribution	The same population is served several times by the same pool of commodities in a well-defined period of time. <i>Example: Food distribution.</i>
	Single Distribution	A group of people or location is served once for the distribution of a specific type of supplies. <i>Examples: NFIs, vaccination.</i>
By Population	Blanket Distribution	In certain geographical locations, all populations within a specific group will receive supplies. <i>Example: Any children of school age receive educational supplies.</i>
	Conditional Distribution	Beneficiaries are selected by specific criteria generally based on vulnerability and needs. <i>Examples: Families with three or more children receive a complementary mosquito net.</i>

Distribution Systems

Distribution systems can be classified according to whom the commodities are given. There are three broad categories of distribution system.

To whom	System Description	Type of situation in which these systems have been used	Advantages	Disadvantages	Prerequisites for Success
Community Leaders	Commodities are given in bulk to a representative of a group of beneficiaries who further divide it among the group.	<ul style="list-style-type: none"> • Early days of an emergency. • Mass influx of refugees. • No formal registration. • Large populations. 	<ul style="list-style-type: none"> • Limited staff needed. • Community leadership structures already in place. The beneficiaries themselves can act as monitors of the distribution process. • Can be used in first stages of a large influx with limited space for distribution. • Can be implemented without registration or ration cards. • Distribution is relatively quick to get started. 	<ul style="list-style-type: none"> • Easy for community leadership and/or the 'strongest' to abuse their position and discriminate against parts of the population. • There may be many levels of re-distribution, from the leadership to many layers of "sub-leaders" until it reaches the individual household. • Distribution may not be equal. Based on the communities' own norms, certain groups or individuals (not at risk) may receive more than others. • Can be difficult for the most at risk to receive proper portions. • Lack of control on beneficiaries' figures. • Difficulty in monitoring the distribution. • If women are not properly represented in the leadership, they may have difficulty of access. 	<ul style="list-style-type: none"> • Good understanding of the social and cultural dynamics. • Spot checks and monitoring to ensure that distribution is equitable. • A strong information system. • An effective complaint mechanism.

Group of Heads of Family	All of the commodities for the group of families are handed over to a representative of the group. The commodities are then immediately redistributed to the individual family heads by the representatives.	<ul style="list-style-type: none"> • When people are settled. • When registration is done and ration cards are available. • Homogeneous groups. • Can be used in camps with small or large populations. 	<ul style="list-style-type: none"> • Promotes social interaction within the refugee community and enhances social adjustment to the new situation and environment. • Influence over the selection of leaders, or introduce new community leadership structures, ensure the representation of women etc. • Shares responsibility for distribution with the beneficiaries. • The beneficiaries themselves act as monitors of the distribution process. • Requires a small number of distribution staff • Quick implementation. • Security problems related to crowd control are minimised by the presence of the family group representatives. 	<ul style="list-style-type: none"> • Needs registration and substantial administration to organise family groups. • An extensive information campaign is needed. • Best suited for homogeneous group of beneficiaries. • Needs reliable and verified population figures. • Abuses by family group representatives may happen. • Monitoring of the final re-distribution within the groups is needed when this is taking place away from the agency distribution site. 	<ul style="list-style-type: none"> • Heads of groups must be chosen by the community. • Spot checks and monitoring to ensure that distribution is equitable. • A strong information system. • Effective complaint mechanism (s).
Individual Heads of Family	Commodities are handed over directly to each family head.	<ul style="list-style-type: none"> • Settled population. • Registered population. • Beneficiaries living in camps, settlements or integrated within the local population. 	<ul style="list-style-type: none"> • Retain control over the whole delivery process right to family level. This may be important in situations where there are inadequate community structures. • Makes it possible to target at risk groups. • Transparency. • Commodities reach the beneficiaries directly. • Easy to monitor that female headed households, and vulnerable families have proper access. 	<ul style="list-style-type: none"> • Very staff intensive. • Needs a large amount of infrastructure. • Needs registration and a substantial administration. • Takes away most of the responsibility for distribution from the beneficiaries themselves. • Can be difficult for the beneficiaries themselves to act as monitors of the distribution process. • Not applicable in early stages of an emergency. • Scooping could prove difficult to monitor. 	<ul style="list-style-type: none"> • Registration and entitlement cards. • Effective complaint mechanism (s).

Adapted from Commodity Distribution, UNHCR

Distributing agencies should always ensure that those who lack the traditional family structures - such as unaccompanied minors, unsupported elderly or disabled people - also receive assistance, and should establish a distribution system that can accommodate this. This might mean grouping vulnerable people into "households" for the purposes of receiving assistance.

The system selection will have an impact in the physical set up for the commodities handover. [See Distribution Process](#) for more information.

Main Types of In-Kind Commodities

Because of the different treatment and care required, is common to talk about two main categories of distributed commodities.

- **Food** - Perishable products for the human consumption - most commonly food.
- **Non-Food Items (NFIs)** - Items that the effected population need to maintain their health and welfare.

Food

Food commodities are one of the most commonly distributed items in emergency contexts. Not only is food universally required, its consumption is constant and cyclical. Agencies involved in food distribution should develop a plan for distribution based on the types and quantities of food to be distributed.

Repackaging

Food is often handled in bulky units, either in the form of large sacks of grain weighing up to 50 kilograms, oil contained in plastic jugs or in metal tins, or sometimes supplemental feeding items in smaller containers. Food may also be distributed fresh – such as whole vegetables - depending on programmatic requirements.

Due to the oversized nature of some food handling units, packaging is often broken down and food manually sorted and distributed in smaller portions. Grains from larger sacks can be proportionally weighed or measured and repackaged in smaller sacks matching programmatic targets, while oil tins may be handed out directly or possibly distributed in smaller quantities. The theory behind repackaging:

- No one person will receive excessive bulk or weight.
- Food rations will be evenly distributed among beneficiary populations.
- Limited storage conditions in beneficiary homes/sites of residence might prevent storage of large volumes of perishable goods.

Repackaging food items requires:

- Pre-planning of the size of the new package to match programmatic requirements.
- Sourcing and identification of appropriate containers and materials for repackaging.
- A strategy for how items are repackaged before they reach the beneficiary.

Items that repackaged should be placed into new containers that are sanitary, rugged enough to survive transport, free from holes and/or prevent spillage, and be made of food grade safe materials. Repackaged items may not need to be specifically labelled, but clearly marked containers may make distribution easier. Labels should be clearly legible, and written in at least the language of the beneficiary population.

Due to the size of most food handling units, it is typically easier to bring the larger containers/sacks of grain or oil to a distribution site directly, and conduct repackaging directly before the distribution occurs. To ensure that distribution is not slowed down, persons tasked with repackaging foodstuffs should:

- Be knowledgeable of exactly what the packaging requirements are.
- Have all the necessary tools to complete the job (weighing scales, sanitary food handling gloves, packaging materials).
- Be adequate in numbers to prevent delays in the delivery of repackaged food.

Depending on the context, some agencies may wish to repackage rations before transporting them to distribution sites, which may work for either smaller distributions or distributions that are planned well in advance. Agencies may also wish to develop repackaging requirements directly into their vendor contracts so that items show up with the appropriate packaging directly to the distribution site.

Food Items with Dependent Demand

Food items are often distributed with dependent demand – this means they are paired together with different types of food items to complete the full nutritional requirements of the beneficiary population. If items are to be distributed together in complementary fashion, a delay to the proper availability or repackaging of one item may be a delay to the whole process. Distribution planners should accommodate for all food items with dependent demand accordingly, ensuring that all items will be ready at the time and location of distribution in the quantities required by the programme.

If one or more item is not ready or not available at any time, either the entire distribution should be delayed, or those delayed items will be removed from the entire distribution to be distributed at a later day. Delays or omissions should be avoided if possible. Setting up a secondary distribution doubles the logistical requirements, while delaying distribution can directly impact a population’s health, and/or cause serious security incidents. If items are missing or delayed at any time, it must be communicated early and frequently to the community through all available channels to avoid confusion or anger on the day of distribution.

All decisions on portion size should be informed by the sectoral expert in each agency. It is not up to the logistics team to determine what portions members of a beneficiary community will receive. The following is a general guide to ration sizes recommended by different agencies:

Commodity gm/Person/Day	UNICEF	MSF	WFP	UNHCR	Oxfam	ICRC
Cereals	350–400	400	400 (450)	400 (450)	350–400	433
Pulses	50	60	20	60	50–100	133
Oil	20–40	25	25	25	20–40	50
Blended food		100	30			
Fish/meat						
Sugar		15	20	15		
Salt		5	5	5		
kcal	1,600–1,970	2,260	1,930 (2,100)	1,930 (2,100)	1,510–2,360	2,450

Non-Food Items

Non-Food Items (NFIs) occupy a broad subset of emergency relief goods, including any essential goods to protect the beneficiaries from the climate and maintain their health, privacy and dignity. Non-food items are closely connected to all sectors; food, shelter, water and hygiene, health and even the education sector can be supported by NFIs.

It is impossible to make an exhaustive list of NFIs as their nature depends on context, the seasons, type of needs, affected population culture, and other factors. A typical list of NFI items might include:

Shelter	<ul style="list-style-type: none"> • Ready-made shelter (<i>tents</i>) • Material to build a shelter (<i>ex. plastic sheeting, rope</i>) • Material to rehabilitate existing shelters (<i>ex. saw, nails, hammer</i>) • Cleaning-up kit (<i>material to clean/clear existing shelters</i>)
Bedding equipment	<ul style="list-style-type: none"> • Mosquito nets • Bed linen and blanket • Mats or mattress • Beds

Kitchen utensils	<ul style="list-style-type: none"> • Stove for cooking • Jerrycan to carry/stock water • Pots • Plates and cutlery • Glasses and cups • Plastic basin
Hygiene material	<ul style="list-style-type: none"> • Soap and shampoo • Toothbrush and toothpaste • Hand towel • Soap for laundry • Razor and shaving cream • Comb, brush • Sanitary towels and baby diapers • Toilet paper • Anal cleansing recipient (<i>in countries where toilet paper is not used</i>) • Children's toilets
Clothes	<ul style="list-style-type: none"> • Gloves • Winter hats • Scarves • Shoes • Coats
Heating and lighting equipment	<ul style="list-style-type: none"> • Stove for heating • Fuel • Oil lamp

Adapted from Pocket guide NFI Distribution, MSF

The overall distribution process of NFIs vary greatly depending on the need, the context and the type of NFI. Much like food distribution:

- NFIs may be distributed as a couple or groups of items that have dependent demand, and all consideration should be made to ensure groups of NFIs should be distributed at the same time.
- NFIs should be a reasonable size and quantity for beneficiaries to safely handle and carry.
- NFIs should be culturally acceptable and in no way increase protection risks for recipients.

Some NFIs, such as plastic tarpaulin, may come in excessively large packaging. In the event NFIs are repackaged or broken down into smaller units, distributing agencies must plan accordingly. Due to the relatively labour intense process of repacking NFIs, and due to the durable nature of NFIs, most agencies may wish to repackage NFIs prior to transporting them to distribution sites. NFIs are typically distributed along programmatic lines, meaning specific sizes are known well in advance. Agencies may wish to conduct a large scale repackaging at once, and keep smaller units within storage for ease of future planning.

Kits

Agencies may wish to combine multiple different NFIs into a consolidated package or set of packages to enable easy and rapid distribution of multiple items covering a variety of beneficiary needs along predetermined lines through a process is known as "kitting". To facilitate the forecasting and final handover activities, (among other parts in the supply chain process) items subject to mass distribution are generally in the form of kits, as for example:

- Shelter Kit for 100 families (*material to build 100 shelters for 100 families*)
- Cooking set (*kitchen utensils for 1 family*)
- Hygiene kit (*Hygiene products for 1 family for 1 month*)

Depending on the time frame, the type of emergency, or the logistical capacities on the ground kits might be built following two different strategies:

Built as...	Description	Advantages	Disadvantages
Standard Kits	Carefully designed and prepared in advance, standard kits are typically developed based on past experience. A quantity of these kits are sometimes available in large emergency prepositioned stocks, and occasionally large international NFI vendors sell pre-made kits.	<p>Quick response:</p> <ul style="list-style-type: none"> • Ready to use, no assembly needed • Pre-positioned (locally, regionally or international) <p>Quality guarantee: the items have been subjected to a strict procedure including market survey, tender.</p>	<p>Not always adapted to local customs. People may find themselves with material they do not know how to use, and therefore the reason for distributing the articles is not covered</p> <p>Some articles may turn out to be culturally inappropriate.</p> <p>Some items are not essential, so people will sell them on the local market.</p>

Kits locally assembled	Locally manufactured - agencies must identify the appropriate local suppliers, assemble and pack kits as needed. The main advantage is that they can better meet the needs of the population taking into account current requirements and cultural habits. Adapted from Pocket guide NFI Distribution - MSF. <ul style="list-style-type: none"> • To meet an urgent need before the kits are available (e.g., blankets in a cold country). • To meet a specific need (e.g., mosquito nets during a malaria outbreak, soap during cholera outbreaks). • To meet the needs of vulnerable groups (disabled, elderly). • To complete a standard kit distribution. 	Highly customisable in terms of items included, packaging and labelling. More economical: limited or no transportation costs. Adapted to local customs. Beneficiaries are more likely used to the core strategies used by aid agencies.	Time consuming: Search for suppliers for the various items (market survey, tender) Assemblage of the kits. No guarantee of quality. No guarantee of quick supply in case of emergency. Often not possible to find all the items locally.
-------------------------------	---	--	--

Kitted and NFI items are often linked to the central emergency pre-positioning strategy used by aid agencies, and both kits and smaller unit NFIs can be developed in conjuncture with a procurement plan. Ideally, vendors will be able to pre-kit items before they arrive at an organisation's warehouse or distribution site, however all or part of the process can be completed prior to arrival, making the overall supply chain process easier.

If vendors are unwilling or unable to meet kitting requirements, then kitting will need to be conducted on the premise of the organisation or its partners. The act of an organisation conducting its own kitting can be very time consuming and require attention to detail. Kitting will need to be formalised well in advance to distribution, but not so far in advance that items inside the kit may expire. Organisations should also account for their own storage capabilities - will they be able to safely store kits matching distribution needs? At what point are they storing too many kits?

Any kit or repackaged item must be transported and packed in durable overpacking capable of withstanding not only the movement in a warehouse or transport to a distribution site, but also transport back to the home of the recipient and potentially even last for weeks or longer inside a beneficiary place of residence. Overpacking should be able to withstand rips and tears, and even be resistant to water damage. Solutions might include packing kits in:

- Durable cardboard boxes.
- Plastic or woven jute bags.
- Inside of other durable distributed items. Example: items can be packed into standard "Oxfam" style buckets that are not only durable carrying cases, but also part of the kit itself.

Planning

This guide does not intent to address targeting or the decisions about what to distribute to who and other key questions; there should be a dedicated technical teams specializing in food security, WASH, education, shelter or other sectors that will have better input on these needs. However, due to the multiple activities needed to distribute commodities on time it is recommended to involve logistics personnel in the planning and decision making process. This will assure that what is decided could be feasible and that the decided plan makes sense alongside other logistics plans.

Distribution should occur once clear evidence informs the distribution plan. Unfortunately sometimes it is not possible to wait until full assessments are done, such as in the first phase of an emergency. In these situations, distributions may start without good planning in order to save lives and/or alleviate the suffering, however it is strongly advised that some form of verification will still be necessary to ensure that the beneficiaries identified have legitimate need. A proper assessment will still need to be completed as soon as possible, but distributions can potentially start without assessments if planners gradually modify their content and systematisation to align with new evidence and contextual information.

Figures

Knowing how many people are affected by a disaster is essential to plan a distribution, however developing a reliable figure of the people in need is not always easy - wide differences can emerge among the numbers given by the authorities, UN Agencies, or those representatives of the population - and can undergo deep modifications over the time. In major natural disaster, the number of defined beneficiaries can change by the hour; and as time goes on, the initial registration numbers become unreliable because of births, deaths and population movement. Uncertainties about numbers are a constant, but it is key that all partners and key actors understand that the exact number of people in need of assistance will not always be known. As the program develops and more information is available, assumptions will change and distributions will more closely align with the verified needs.

Some form of registration is necessary for all distributions, but the type of registration may vary from simply estimating the total number of beneficiaries, to collecting detailed information on each family and/or individual. The method of registration used is closely linked to the system of distribution adopted, and either communities themselves or external agencies can register the potential beneficiaries of a program. In most programs, the initial list of beneficiaries is produced with the assistance of community leaders or by government officials. Registration is a continuous exercise, requiring regular verification by checking registration data, and comparisons with other estimates of population numbers.

Distribution Plan

A distribution plan needs to consider beneficiaries' interests, security and logistical constraints, the form and frequency of anticipated distributions, the number of individuals who will receive distributions, and the resources available.

If safe, logistically possible, and appropriate for the population, distribution of all items at once or over the course of a single day minimises the cost and effort for the distributing agency. Single distributions are also a more convenient arrangement for beneficiaries who have to travel long distances to reach distribution sites.

In other contexts, a phased approach may be more appropriate, with distribution occurring over multiple days, or even different distributions separated by multiple days. Phased delivery might be due to:

- Distribution space being dedicated to other activities.
- Delays or shortfalls in procurement of distributed items.
- National or religious holidays.
- Insecurity.
- Prior arrangements with beneficiary populations.

A phased approach can still meet the most urgent needs of a population, and focus can be placed on prioritised groups at high risk. A second or more rounds of distributions can then follow accordingly.

A distribution schedule must be designed carefully. It should include a clear schedule of working hours and set a realistic distribution target. The schedule should be shared with logistics focal points for warehousing and transport to ensure that commodities can be prepared and delivered as planned.

A good way of planning the supply movement of a distribution is to roll back the time required for preparation based on an expected day of distribution.

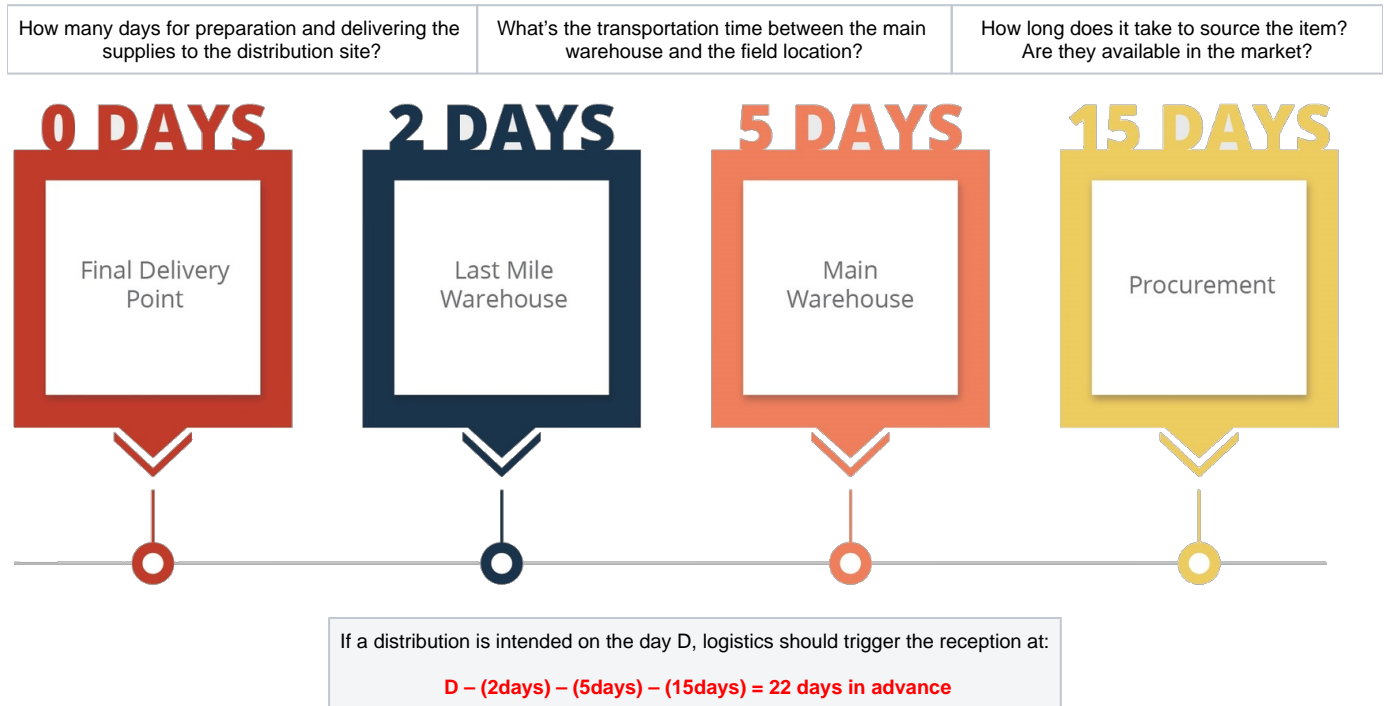

Pragmatism is essential, but problems may arise when the original technical principles are forgotten.

Process

The distribution process in general can be divided in three stages:

1. [Setting up](#)
2. [Running the distribution](#)
3. [Closure/reporting](#)

Another way to look at this is following a timeline; Before Distribution – Day of Distribution – After Distribution.

Setting Up the Distribution / Before Distribution

In the days before the distribution, implementing organisations should think about how they will set-up and manage the distribution in a manner that is effective, efficient, safe, and respectful of the needs of beneficiaries.

Approach

The decisions made regarding the distribution approach should take into consideration the information provided by the assessments about needs and size of beneficiary population, including: the types of beneficiaries being served, the number of beneficiaries being served, the existing coordination and community leadership structures, the population literacy level and the security and access situations in the area.

Two questions arise when deciding the system to be implemented:

- How much responsibility is appropriate/efficient/worthy to give to the beneficiaries themselves?
- What kind of resources (i.e., time, space, staff, financial resources) are available to set up and run the system?

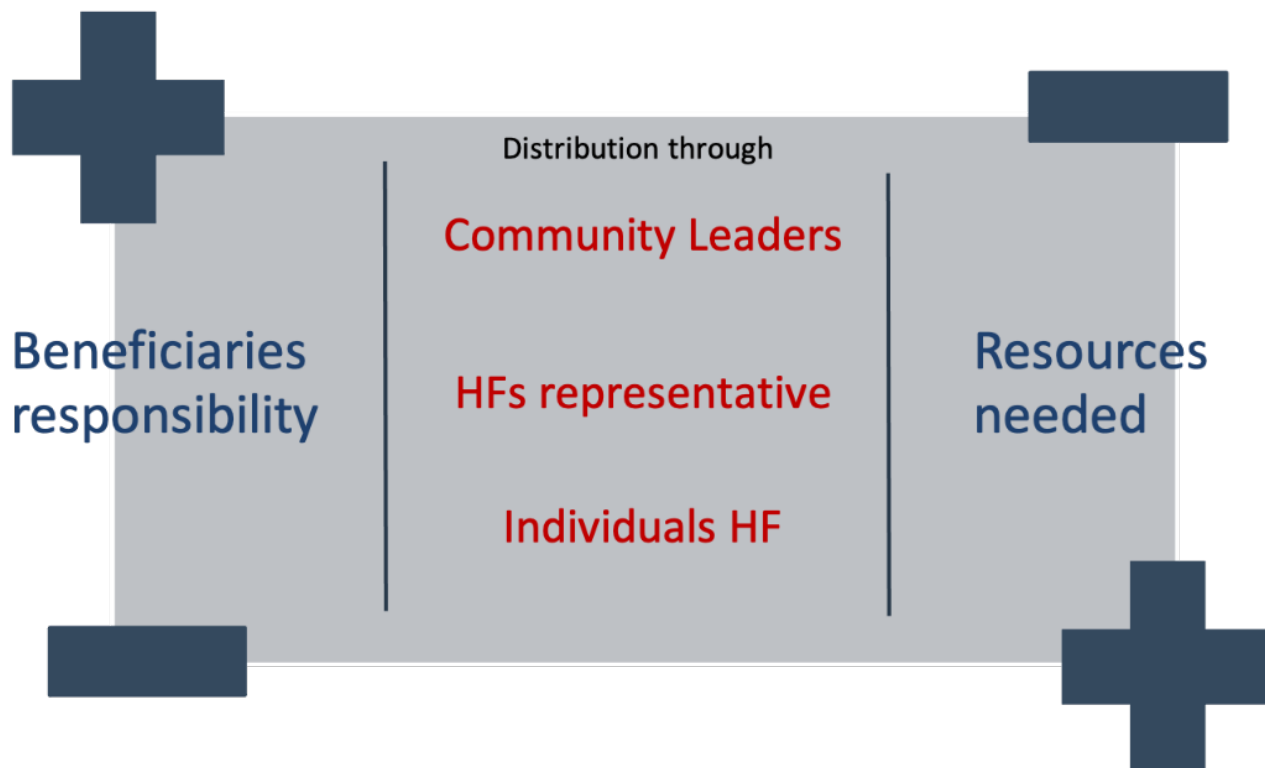

Another key aspect to consider when deciding the approach and setting up a sound distribution system is the access.

Access includes a variety of considerations including how individuals are informed about the distribution, how they will get to the distribution site, how they will transport the aid back to their homes, whether they will feel secure getting to and moving within the site, and whether they know how to use the aid provided. A critical element of ensuring access is the dissemination of information. Beneficiaries must be continuously and directly informed, not just through community leaders, about the distribution process and their entitlements as recipients of humanitarian aid.

Sites should also be established in a way that minimises the number of people who are attending a distribution at any one point, as this can be a critical element of crowd control and in ensuring equitable access to humanitarian aid. One way of avoiding large crowds is to call different communities on different days, while another way is to create multiple distribution points to be managed simultaneously. An organisation's decision on how to organize a distribution should be based on a variety of factors as detailed below:

	Few distribution points	Many distribution points
Advantages	<ul style="list-style-type: none"> • Need less staff. • Less infrastructure, sites, distribution structures, roads. • Less transport required for distribution. 	<ul style="list-style-type: none"> • Fewer crowd control problems. • Easier access for women. • Shorter journeys home. • Beneficiaries can see the distribution taking place. • Special arrangements easier.
Disadvantages	<ul style="list-style-type: none"> • Longer journeys to the households. • Potential crowd problems. • Difficult for beneficiaries to see the distribution. • Difficult access for weaker groups. 	<ul style="list-style-type: none"> • More staff and transportation needed. • More structures, roads, access, cleared sites needed for distribution.

UNHCR

Location

A range of factors will determine the location and number of distributions centres. They include the number of refugees and the number at each site, their locations and the distance between each location, and the availability and location of resources such as storage sites.

As a general rule, it is best to have the distribution points as close to the beneficiaries as possible. For dispersed populations, beneficiaries should not have to travel more than 5 kilometres at a time, however terrain, conditions and insecurity may require that distribution points are established less than 5km. If it is not possible to locate the centre within walking distance, arrangements should be made to transport refugees to and from the centre. In selecting distribution points, factors affecting vulnerable people's physical access should be taken into consideration, such as physical security of women who may be threatened, if beneficiaries need to pass near a military/police camp, the ability of disabled people to travel long distances, the inability to travel in the dark. Local tensions between ethnic or religious groups should also be considered when identifying which groups will receive aid in which locations.

The selected location must fulfil some conditions to facilitate the proper set up of the distribution. Distribution sites must be:

- Accessible for trucks or other vehicles used for transporting distributed items.
- Not overly exposed to wind or sun.
- As much as possible free from insects and other vectors.
- Not be prone to flooding.
- Easy to secure and evacuate if needed.
- Clearly marked in the appropriate language.
- Be free from debris or other harmful items.

Ideally, distribution points should be located far away from crowded areas such as markets or hospitals, in enclosed areas such as schoolyards that enable the distribution team to control entry and exit, and avoid over-crowding. Distribution teams can also create their own enclosed sites with stakes and rope or other local materials, in which aid agencies may have to invest in additional crowd-control staff to ensure order within the site. Distribution points should never be in the vicinity of military barracks or facilities, nor should they be in locations that force beneficiaries to travel to or through highly militarised areas.

Organising Distribution Sites

Distribution sites must be constructed in such a way that distributions and the collection of commodities can be carried out safely, efficiently and in an orderly way. UNHCR recommends at least one distribution site per 20,000 individuals and two distribution staff per 1,000 beneficiaries, not including monitors or security staff.

In general, distribution sites should be:

- Secure enough to ensure that items are not stolen or misappropriated.
- Near to water points and constructed with separate latrines for men and women.
- Big enough for on-site commodity storage and shelter for queuing during delays or rain.
- Near to rest facilities for distribution workers.
- Constructed near to vegetation or trees, which provide shade and act as windbreaks.
- Provided with chairs or benches for persons unable to stand in line.
- Safe for women and children.

Site Layout

The layout composition of a distribution site will depend on factors including the available terrain, the weather forecasted for the distribution day, the distribution system, the size of the affected population, the available permanent structures. Every distribution site must have:

- Separate entry and exit points.
- A waiting area (*a place in which people can wait before being called for distribution*).
- A separate entrance and waiting area for vulnerable and PSN cases, assuring a protection presence to help identify them and provide referrals.
- A registration area.
- A handover area where people receive items.
- A storage area for the commodities and equipment (*permanent buildings, tent, lorry or clearly marked open space*).
- Staff facilities: latrines and source of water, but also a rest area for a 10-minute break away from the crowd and sheltered from sun or cold.
- Population facilities: latrines, water, covered resting space.
- The presence of a complaints desk, if this is the chosen method for dealing with complaints.

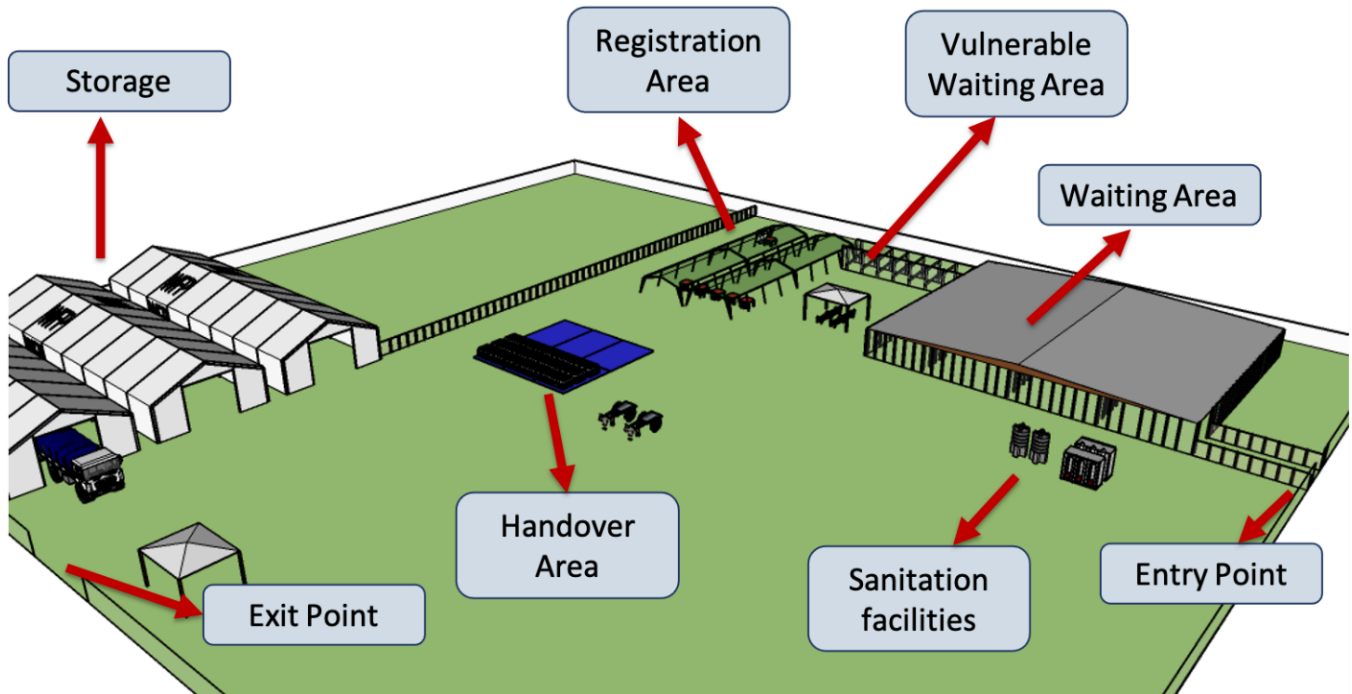

Some of the main characteristics include:

- A clearly delineated distribution space.
- Different lines for men and women if needed and when culturally appropriate.
- A simple structure that facilitates the flow of beneficiaries through the distribution point; progressively organise people into single lines.
- The registration stage can be used to organise the beneficiaries according to the supply types (e.g., grouping different family sizes).
- A one-way flow of beneficiaries: avoid flows of people that overlap or the need to have people moving against the natural flow of distribution.
- Clear space between where people are waiting and the stacks of commodities for distribution.
- The waiting and registration area should be both shaded and have the presence of bathroom facilities in case beneficiaries have to wait for extended periods of time. Ideally there should be sufficient latrines for the crowd, but this is not practical in view of the large numbers of people assembled on the site. A rapid distribution will help offset the limited shade or facilities, as well as preventing beneficiaries from having to wait excessively long.
- It is important to provide a water source, especially in hot weather.

A general layout might look like:

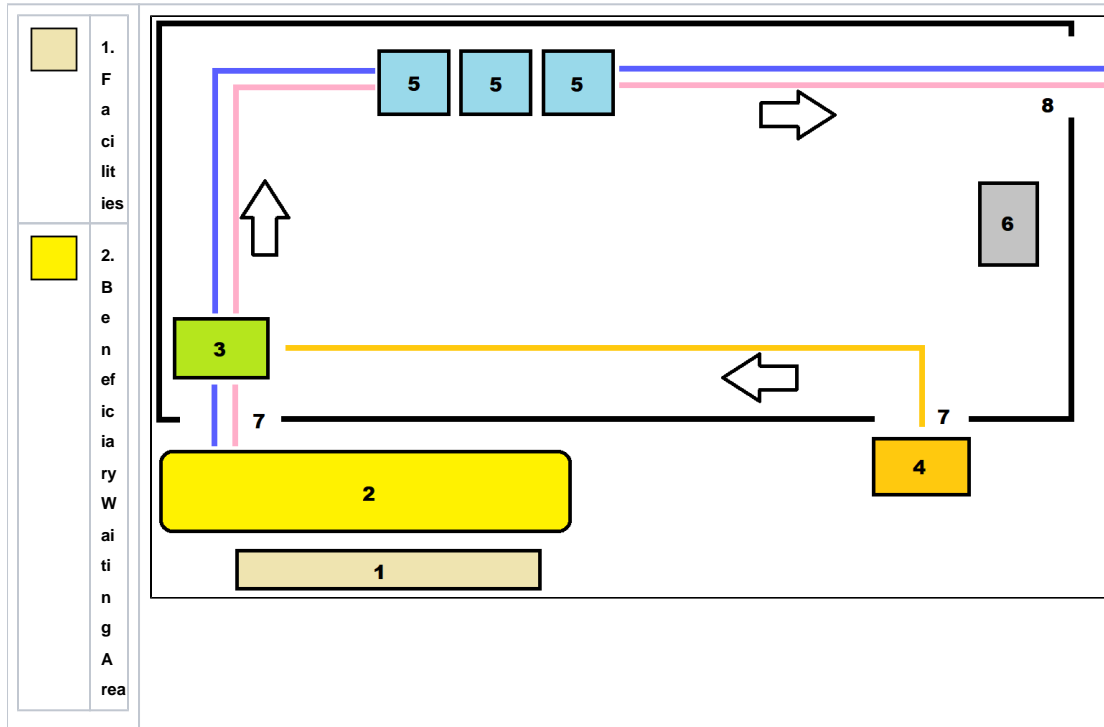







3.
R
e
g
i
s
t
r
a
t
i
o
n
A
r
e
a



4.
P
e
o
p
l
e
W
i
t
h
S
p
e
c
i
a
l
N
e
e
d
s
(
P
S
N
)
P
r
o
t
e
c
t
i
o
n
D
e
s
k

	5. N F I D i s t r i b u t i o n A r e a
	6. C o m p l a i n t s D e s k
	7. E n t r y P o i n t s
	8. E x i t P o i n t s
	9. M a l e L i n e
	1 0. F e m a l e L i n e

People with Specific Needs (PSN)

An extra effort must be made to assure the distribution is accessible for all beneficiaries and that any potential special needs are covered. Beneficiaries with special needs may include older people, small children, those with impaired mobility, or breastfeeding mothers among others that could require any other special assistance or at risk.

Some measures can be implemented to assure that special support is provided without marginalising or undermining beneficiaries:

- Remove physical barriers.
- Prepare fast track queues and dedicated waiting areas.
- Train the staff and given resources to assist PSN.
- Facilitate transportation of heavy or cumbersome items from the distribution site back to individual homes with wheelbarrows, donkey carts, or community support groups.

Distribution area with pull carts to assist PSN reach their home location:

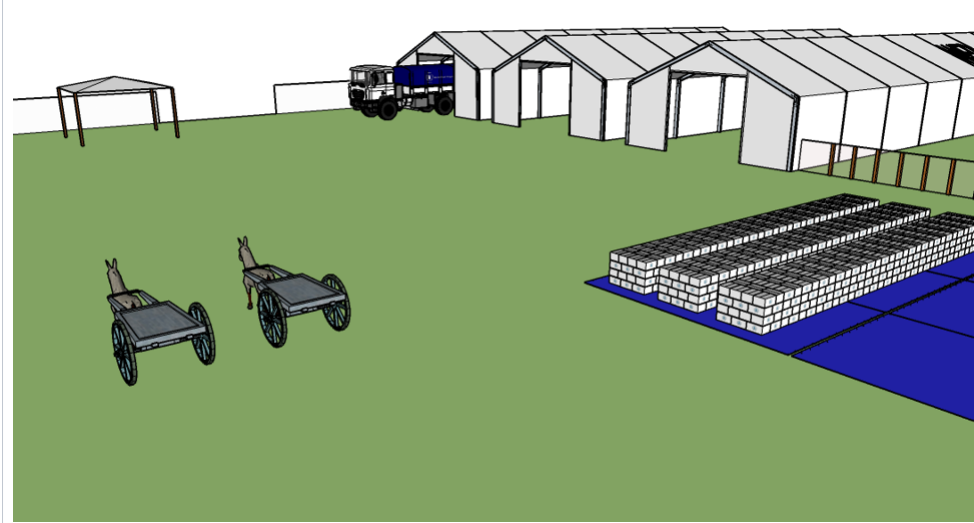

Distribution Teams

The size of a distribution team should be linked to the size of the distribution. Generally, the larger the distribution, the larger the team. At a bare minimum, distribution teams should contain the following:

- A team leader, who will be the primary focal point for communications with community leaders and beneficiaries.
- A logistics focal point to deal with offloading, counting of items, temporary storage, and arrangement of kits.
- A security focal point who is responsible for monitoring the security situation and making decisions, in consultation with the team where possible, on the evacuation of staff and/or abandonment of supplies.
- A complaints focal point to deal with issues on-site as they arise.
- A protection focal point, if possible, to assist in identifying vulnerable cases, facilitating their movement through the distribution point, and referring people for additional services as needed.

The rest of the team will usually be comprised of locally hired individuals who can fill the following roles:

- Translators.
- Crowd controllers.
- Enumerators to support check-in.
- Demonstrators (if necessary, to demonstrate the usage of a particular commodity).
- Off loaders/kit packagers.
- Security, as needed.

All distribution staff should be visible to both other staff and beneficiaries by wearing hats, vests, or other visibility materials, and be provided with the any equipment needed to accomplish his/her work.

Teams should be made up of both genders and be sensitive to the political context by trained and sensitised as well as informed and committed with applicable codes of conduct and protection measures.

The handover of food or commodities is a highly sensitive moment, especially if it is not well managed. Staff must be familiar with the general distribution organisation and understand his/her role, be able to answer questions or how to redirect them, and be instructed to know what to do in case of running problems or major incidents. The staff working on the front line or dealing directly with beneficiaries must receive specific training.

Pre-Positioning Supplies

Sufficient commodities for the distribution ideally should be pre-positioned in the distribution enclosure the day before distribution. The pre-positioned quantities are based on prior calculations based on the number of beneficiaries to be served and the ration agreed upon. Up to 5% extra commodities should be pre-positioned to allow for damages, mis counting or additional beneficiaries.

Communicating with Beneficiaries and Host Communities

Providing the intended beneficiary population with full information before distribution is the key to a successful, problem-free distribution.

The distributing organisation is responsible to duly inform recipient on the basis on what, when, where and how items will be distributed, and what criteria determines who will obtain items. The rationale employed will be different in the first phases of a rapid onset emergency than it will in longer protracted crisis. The key for any agency is to find the best approach to reach the affected population assuring that every vulnerable individual have as much accurate information as possible about the distribution.

Pre-distribution announcements should:

- Reach out to all different groups of the population using multiple channels of communication.
- Particularly involve women and the distribution committees (if already in place) in order to avoid information going out only through the community leaders, who might have their own political agenda.
- Use different methodologies and means such as meetings with groups of beneficiaries (including those at risk), posters and picture messages, information boards, radio, megaphone and others.
- Use the local language and reach out also to those who are non-literate.
- Allow them to fully understand the messages and give feedback.

During an information campaign, it is needed to indicate clearly:

- Distribution is free of charge.
- How refugees can report any abuses by the staff who manage distributions.
- Who will receive the commodities that are to be distributed, and selection criteria (if relevant).
- What items refugees are entitled to receive (quality and quantity).
- When distributions will occur (date and time).
- The location of distribution centres and the areas (populations) that each will cover.
- How distributions will be organised and how those who receive distributions should behave.
- The purpose and use of the items distributed (to avoid misuse or undesired effects).
- When future distributions are planned, and their frequency, so that refugees can plan ahead.

The Day Before the Distribution

Prior to the launch of the distribution, the team needs to ensure that all structures, commodities and equipment are in place and that operating procedures are clear; this can help to expedite the distribution process and reduce the chances of disorder or problems at the site.

The team leader must ensure that everyone involved in the distribution knows their role, what is expected from them, and have enough knowledge about the exercise itself. A briefing to the core team is mandatory, and detailed briefings should be given to specific staff, such as those persons involved with crowd control, registration team, or complaint mechanism.

The Shelter Cluster has developed a check list as a guide:

Checklist for the Day Before the Distribution

The team leader should brief the core distribution team on the following:

- The number and type of items to be distributed per household.
- Each team members' specific role during the distribution.
- The distribution process (a walk-through of the site).
- The start and end times each day, as well as any breaks (i.e. lunch), as agreed beforehand.
- The complaints mechanism.
- How issues or concerns should be raised throughout the day.
- Means for feedback on the process; e.g. evening meetings to discuss how the distribution is going, any issues, gaps, etc.

Ensure organisers have the necessary enrolment lists for the first day of the distribution.

Ensure that all team members have functional communications equipment (VHF radio, mobile phones, etc.), and that all team members know how to reach each other.

Ensure that all needed local staff including daily labour have been identified and are aware of responsibilities and start/end times each day.

Confirm that the beneficiaries have been notified of the distribution, as per the plan.

If possible, pre-position all supplies in the right quantities at the distribution site (or nearby); the distribution organisation may need to hire security to watch the items overnight.

Have the following items ready for the distribution (as needed):

- Drinkable water for the distribution team
- First Aid Kit
- Ink pad
- Cutter/knives (for stock)
- Megaphone (if needed)
- Pens
- Masking tape/extra rope
- Flag or visibility materials, if available
- Vests or arm bands for casual workers
- Empty enrolment forms, if applicable
- A hole punch
- Table and chairs for staff and vulnerable people

If applicable, ensure that vehicles are filled with fuel and in good working order.

If applicable, ensure that the equipment above has been loaded into the vehicles.

Adapted from Shelter Cluster

Day of Distribution Operations

Once all the members of the distribution team are in position on the day of distribution, all possible questions or concerns from staff are addressed, the commodities are in place and beneficiaries have been assembled in the waiting area, the distribution can begin.

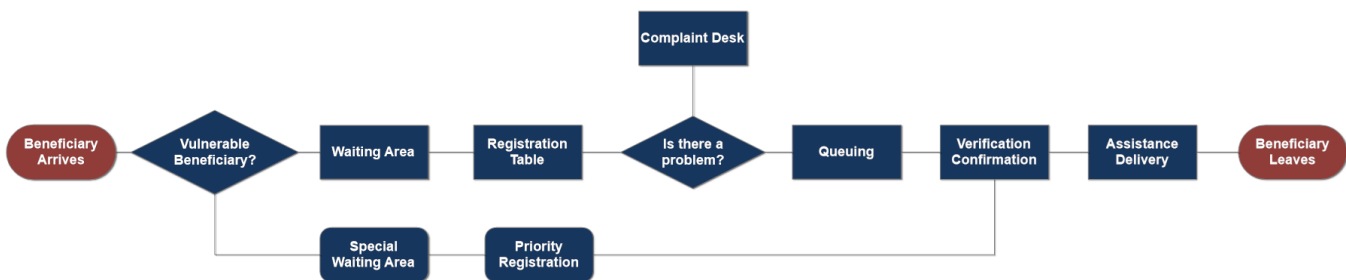

Registration/Verification

The first step during the distribution is the registration and control of beneficiaries. Registration is the stage where intended beneficiaries are confirmed as eligible. It is also the moment when the distribution team can ensure the distribution is documented and that the resources distributed have an identifiable beneficiary at the end of the chain.

Three different methodologies for registration exist:

- Manual Distribution Lists
- Distribution Cards
- Biometric/Digital Control

In order to prevent duplication and omissions of records, it is preferable that the registration and verification take place at the same time, assuring a proper segregation of duties between different parties. Programs with limited staff will often combine the process of collecting, processing and verifying registration data into one team. To minimise data manipulation and fraud, however it is important to segregate these tasks.

The staff responsible for registration/verification must assure the following steps:

- Train personnel involved in registration process, define team composition and division of tasks, consider potential challenges between the information collectors and respondents (such as language barriers and gender norms).
 - Define roles and tasks (data collection, data cleaning, data processing and backing-up) in standard operating procedures (SOPs).
 - Train teams on all elements of the participant registration process: data protection principles, informed consent and workflows.
 - Explain the registration objectives and highlight any data security risks and mitigation strategies.
 - Introduce SOPs and applicable protocols.
- Conduct a post-training skills check and address any knowledge gaps.
- Monitor the registration process and provide mentoring and feedback. At the beginning of the registration process, teams should regularly check the quality of data collected (i.e., blank fields, differing usage) to identify any gaps.

Manual Distribution Lists

Largely used for small to medium sized distributions in “one shot” interventions designed to tackle a specific need. This methodology consists of the collection and registration of beneficiary information manually on paper using a standard form to capture basic data. This simplified process facilitates the implementation and flow of ad-hoc/first time distributions, however, all the information gathered should be cleaned and processed manually at a later stage; as manual registration is prone to human error, the monitoring/reporting process may become cumbersome.

A manual distribution list will likely only contain beneficiary names and some household information, but no quantitative way to track individuals. Ideally, beneficiaries should produce some form of ID to match the list, but this is not always possible, especially in the early stages of an emergency. The manual list method also frequently utilises fingerprints or a signature as verification source, which cannot be verified in real time and largely can only be used for resolving claims of fraud or misuse after the fact.

Distribution Cards

Distribution cards are commonly used in camps or in situations in which cyclical distributions are common. Distribution cards are also useful when the beneficiary list is consistent. This methodology utilizes the creation and distribution of cards made from plastic or some other durable material. To facilitate this, organisations involved with distribution will intentionally identify Individuals or families who frequently receive distributed items through a formal registration process, and provide each individual or family with a distribution card. Distribution cards might include a serial number or ID code that refers to specific households containing all the information gathered during registration. The serial number or ID codes and correlating beneficiary information are maintained in separate system, usually an electronic database through which numbers can be quickly searched. Paper lists might be used in some situations where a computer database isn't accessible, but it is important that paper lists contain ID or serial numbers, and that data captured at the point of distribution is re-entered into a database later.

While a card system will require some investment on databases as well as time to gather information, prepare, issue and distribute the cards, this methodology greatly facilitates the registration process, especially if the card can be read by a bar-code or similar machine. Cards should ideally be accompanied by another source of verification at the time of distribution to assure the beneficiary identity.

Biometric/Digital Control

Biometric registration refers to the process of tracking recipients of distribution using unique biometric features of individuals. Biometric features might include fingerprints, eye, or facial features, all of which is automatically captured by recognition software and linked to the individual with a server-based database of beneficiaries. A biometric database might even be used at different geographic points if the beneficiary is migrating or mobile. While many biometric tracking systems are still developing due to high levels of sophistication and data management required, the use of this technology is increasing. A biometric system not only reduces input and duplication errors, but they also facilitate update, back-up, reporting, monitoring and auditing controls.

Any time biometric data is used to track beneficiaries, organisations should consider social and political implications of biometric tracking, and place protection concerns at the highest level. Information that can track an individual across multiple locations and time can also be used to target vulnerable persons, and may be the subject of scrutiny by law enforcement, armies and even non-state actors. Before implementing a biometric registration process, agencies should consult with protection professionals about concerns, and with local government bodies about laws governing gathering biometric data.

Safety

Security measures used in a distribution should be defined according to the risks involved. These risks can go from small-scale robbery to large-scale coordinated attacks and the same activity in different places will have different risk factor.

Distribution sites can quickly become chaotic, crowded and potentially dangerous places to both field staff as well as beneficiaries, particularly when there are long wait-times or commodity shortages. Security at distributions is usually the responsibility of government authorities. However, in some conflict situations, local law enforcement authorities cannot be viewed as neutral, and other crowd control mechanisms may be necessary. Once serious disorder has broken out there is little that humanitarian actors conducting distribution can do except to ensure the safety of the distribution staff, usually through evacuation.

Distribution teams can often prevent these situations through good site selection and design, through following operating procedures, and by positioning sufficient and trained crowd control personnel strategically throughout the site to facilitate flow, minimising long waiting periods to the extent possible, and dealing with fraud or cases of cheating in a quick and transparent manner.

During a distribution plan, program, logistics and security teams should work together to define such rules.

- The first layer of a security mitigation measure is community involvement: it is key to have local leaders supporting to spread the distribution rules and criteria. Special teams that communicate with communities also play a critical role in informing people about the activities and criteria of assistance.

- The presence of security forces should respect a strict progressive use of force approach when managing crowds. Force should only be applied when absolutely necessary, and in accordance with the level of threat.
- Have a prepared contingency plan and an evacuation strategy.
- Information is key: good visibility and constant community engagement help to keep people under control, especially in the case of shortages or changes in the food basket or distribution systems.
- Mind people's minimum comfort needs: water, shade, access to sanitation.
- Appoint one person to be responsible for security decisions on the spot. Make sure that all other staff are aware of which person it is. He/she should be easily visible.
- Provide staff with communication means like radios, whistles or establish another method to signal an emergency.

Complaint/Feedback Mechanism

It is important to acknowledge beneficiaries' concerns and complaints while referring those with specific problems to access the distribution services. A complaint or feedback system must be in place, ensuring complaints are recorded, documented and are addressed accordingly. A help-desk should be visible and be accessible without impediments, but also be away from the waiting area to ensure privacy and personalised support. It is advisable to appoint a representative from the distribution committee in the help desk. Any help desk should be able to converse in the language of the recipient population, and ideally be taken from the local community

It is important to differentiate between complaints and questions. Throughout a distribution, staff will very likely be approached by beneficiaries, authorities or others arising issues as:

- Lack of familiarity with distribution procedures and location.
- Lost, missing or incorrect ration cards.
- Faulty items or bad quality food.
- False claims in order to receive more items or food.

It is strongly recommended to brief the staff closest to the crowd about how to deal with questions and how to refer them to the help-desk if necessary. Efficiently responding to questions and complaints will have direct impact on the number of security issues likely to further arise.

Closure / After Distribution

Distributing organisations are also responsible for the proper closure and clean-up of a distribution site. Generally, this includes clearing the site of any refuse, resolving any outstanding issues, compensating casual labourers, and putting a plan in place to report on and monitor the results of the distribution.

Reconciliation

After the distribution, warehouse and distribution teams should reconcile and agree upon the correct number of items dispatched and distributed, spotting problems such as: excess distribution and mistakes on waybills, registration problems and thefts, or other discrepancies. The shorter the time between activity and reconciliation the easier it will be to find mistakes. The distribution team will need to submit an activity report which requires the use of warehouse data and the reconciliation is a mandatory part of the process.

All the below figures should account for:

- Amounts dispatched from the source and received at the distribution point.
- Amount distributed.
- Balance left after distribution/showing as a return from distribution.
- Balance recorded at source following reception of returns.
- Any registered losses.

Reporting

After a distribution, it is essential that a distributing organisation report internally and externally on the intervention and its results, allowing all stakeholders to know results, including shortfalls or gaps in numbers of population served. In general, every report should include information on which commodities were distributed, in what quantities, to which populations, in which areas, and in what time period. If all of the needs of the community were not met during the exercise, it is suggested that the distributing organisation include the percentage of total needs met. Any problems that occurred during the distribution should be noted, particularly if they may impact the ability of partners to operate in the area moving forward. Photos with captions should be attached to the report, where possible.

In order to consolidate the different reports is a good practice to agree and use the same template every time. The Shelter Cluster designed one that contains the following information based on UNHCR templates:

Item	Description
Distributing Organisation	Fill in the name of the organisation that organised the distribution.
Site(s) and Location	Fill in the name of the distribution site (e.g. Name of a School) and its location (governorate, district, village/neighbourhood).
Date(s) of Distribution	Give the exact dates of the distribution, inclusive (e.g. January 4-7, 2017).
No of Beneficiaries	Give the total number of beneficiaries served through the intervention, dis-aggregated by gender and age.
Rations	Specify what each household was meant to receive, including whether different packages were delivered to different sized families (e.g. 3 blankets/family of 6, 1 bar of soap/person).

Initial Stock Count	Give the number of items delivered at the outset of the distribution, listed by item (e.g. 1,000 blankets, 1,000 mattresses, etc.).
Stock Distributed	Give the total number of items distributed, listed by item (e.g. 850 blankets, 850 mattresses, etc.).
Remaining Stock Count	Give the number of remaining items, if any, listed by item (e.g. 150 blankets, 150 mattresses, etc.). Ideally, this number will equal the initial stock count minus the stock distributed.
Percentage of Needs Covered	Give an estimation of the needs covered. If there was a shortage of stock, then this number will be below 100%. Similarly, if there are new arrivals, the team might note that the needs as per the assessment have been covered but that new needs have arisen.
Distribution Approach	Detail how the distribution was set up and managed.
Problems Encountered During the Distribution	List any problems encountered during the distribution such as fraud, issues of access, claims of exclusion, etc.
Plan for Follow-up	List any actions that the organisation plans to undertake in the aftermath, e.g. a PDM or a follow-up distribution to account for new arrivals.

Evaluation

Following the full closure of a distribution, distributing organisations may want to start thinking about conducting a post-distribution monitoring (PDM) exercise in order to assess the effectiveness, appropriateness and coverage of the intervention, and overall satisfaction with the assistance provided. Ideally, PDMs should evaluate a single response about a month after the intervention occurs. This allows time for beneficiaries to use the items provided and give useful feedback on quality, and account for the possibility that the recipients of aid might have moved.

In parallel, agencies may wish to perform a market survey where the price of commodities on the local markets is collected regularly. The market tends to be distorted in emergency or conflict contexts, and there can be large fluctuations in price provoked by the timing of distributions making very difficult to interpret quantitative data. Market surveys may reveal impacts of distributions on local vendors, if items are being resold, or even if cheaper or more appropriate items are available locally for procurement or cash vouchering.

Key Actors

It is important to know the roles and responsibilities of the main actors involved at various stages of commodity distributions. In most circumstances, key actors include the following:

- Affected people: IDPs, returnees, host communities or other potential recipients of aid.
- Distributing agency: Agency, NGO or any of kind of partner conducting the distribution.
- Donor or Contributing Organisation: Agency contributing with stock, funds, or other kind of support to the distribution.
- Government authorities: local or national authorities covering the area of intervention.
- Cluster: coordinating body that can assist in the organisation of the intervention.

The roles and responsibilities of each of these key actors may include:

Actor	Roles and Responsibilities
Affected People	<ul style="list-style-type: none"> • Assistance in distribution planning. • Assistance in the identification of people at risk. • Establishment of committees with adequate representation of women. • Information-sharing on the specific concerns of different groups. • Dissemination of information on the commodities and the distribution process and system. • Crowd control at the distribution site and other casual labour for distribution related activities. • Assisting vulnerable members of the displaced population.
Distribution Agency	<ul style="list-style-type: none"> • Establishment of distribution site and distribution-related processes. • Dissemination of information to affected populations. • Management and equitable distribution of relief commodities using the appropriate distribution system. • Participation, inclusion, safety, and accountability in the distribution process. • On-site monitoring of distribution processes. • Reports on quality, quantity and impact of commodity distributions.
Donor or Contributing Organisation	<ul style="list-style-type: none"> • Movement of stocks to the field for distribution (if applicable). • Provision of funds or other types of support for the intervention. • Guidance on technical issues where appropriate, e.g., protection referrals. • Monitoring the distribution program and reporting to donors and governments as relevant.

Government Authorities	<ul style="list-style-type: none"> • Security and the creation of safe spaces for distribution. • Creation of initial beneficiary lists in consultation with communities (when appropriate). • Free and safe access of relief personnel to beneficiaries and of beneficiaries to aid. • Consultations on distribution set up, approach, and process. • Relevant permissions.
Clusters	<ul style="list-style-type: none"> • Coordination of the distribution and support for additional capacity if needed. • Advocacy around access. • Receipt and review of distribution reports. • Information management • Creation of intersectoral coordination spaces.

Adapted from Shelter Cluster

Distribution Committees

To assure the affected population involvement in the process and guarantee that its participation is efficient and effective, a best practice has shown to be the creation of distribution committees. Distribution committees tend to work better in stable environments, should ideally reflect the ratio of men and women in the population, and all population groups should be represented. Committees can meet both before and after distributions, where all issues related to distribution should be discussed freely inside the committee and brought to the appropriate agency's attention. These committees will act as a link between the agency in charge of the distribution and the affected population, helping to:

- Keep unrealistic expectations in check.
- Ensure overall understanding of procedures and restrictions.
- Ensure receipt of feedback from the community or camp population on all issues related to distribution.

Protection Considerations

Protection mainstreaming means distributing organisations, partners, employed third parties and all other entities involved in the distribution are undertaking activities in a manner that safeguards people from violence, coercion, deprivation, and discrimination.

The distributing organisation should undertake all effort to integrate protection into every part of the distribution process incorporating the four key elements of protection mainstreaming, which include:

1. Avoiding causing harm and prioritise safety and dignity.
2. Ensuring meaningful access.
3. Practising accountability.
4. Promoting participation and empowerment.

A protection-based approach should be included when planning the logistics of distribution to advocate and highlight the importance of impartiality and non-discrimination to achieve a successful and sound distribution. All members of the team have a role in ensuring the safety, dignity and integrity of people in aid distribution. Coordination, fairness and planning are crucial to respond to their specific needs, cultural values, physical context and environment preservation.

As a compendium, the following list should be considered:

- Distribution times are safe for beneficiaries to travel to the distribution point and return home without exposure to further risk of harm.
- Physical location of the distribution can be easily and safely accessed, particularly against the risk or threat of gender-based violence and attacks from armed groups.
- Commodities distributions are designed to be respectful and inclusive of cultural and religious practice.
- Commodities distribution methodology are designed to preserve safety and dignity.
- Options for home delivery of shelter materials/NFIs for vulnerable persons (e.g., persons with disabilities who cannot access the distribution point, elderly, child-headed households, etc.) or systems by which representatives can collect assistance packages on their behalf.
- Commodities are packaged in a way that avoids injury or strain to beneficiaries. Distributed items should not be of excessive size or weight, and should be easy to manage for elderly or persons with disabilities.
- The provision of additional NFIs essential for personal hygiene, dignity and well-being, including sanitary materials for women and girls are consistent with cultural and religious traditions.
- Complaints mechanisms and monitoring are integral to the distribution plans.

Sites and Resources

- [Sphere Project Handbook \(2018\)](#)
- [Universal Logistics Standards \(ULS\) Handbook](#)
- [UNHCR Commodity Distribution Guide](#)
- [The Cash Learning Partnership](#)
- [PARCEL Project](#)
- [Humanitarian Logistics Association](#)
- [Core Humanitarian Standards](#)

References

- [1] Source: Commodity Distribution, a practical guide: Division of Operational Support; 1997, UNHCR.
- SHELTER CLUSTER, (2017). Guidelines for the distribution of Shelter/NFI kits
- OVERSEAS DEVELOPMENT INSTITUTE, (1995) *General Food Distribution in Emergencies*. Susanne Jaspars and Helen Young.
- NORWEGIAN REFUGEE COUNCIL. Camp Management Tool Kit. Food distribution and Non-Food Items.
- MEDICINS SANS FRONTIERS, (2009). Pocket Guide NFI Distribution.
- OXFAM, (2008). NFI Distribution.
- IASC, (2006). *Gender and NFI in Emergencies*.
- WFP, (2013). *Food Assistance with Safety and Dignity*.
- WFP, (2002). *Emergency Field Operations Pocketbook*.
- UNHCR, (1997). *Commodity distribution, a practical guide*.
- UNHCR and WFP, (2011). Memorandum of understanding
- UNHCR (2020) *Guidelines for Reducing Protection Risks in in-kind Distributions*.