









Cargo Vehicles Sizes

Type	Axles	Max Gross Weight (Tonnes)	*Estimated Payload (Tonnes)	Typical Total Body Length (Meters)	Body
Single Unit Truck	2 axles / 4 wheels	3.5	1	Various	
Single Unit Truck	2 axles / 6 wheels	7.5	3.5	Various	
Single Unit Truck	2 axles / 6 wheels	18.8	12	12	
Single Unit Truck	3 axles	26	18	12	
Single Unit Truck	4 axles	36	25	12	

Cargo Vehicles Sizes

Type	Axles	Max Gross Weight (Tonnes)	*Estimated Payload (Tonnes)	Typical Total Body Length (Meters)	Body
Tractor Trailer Truck	3 axles	26	18	16.5	
Tractor Trailer Truck	4 axles	38	24	16.5	
Tractor Trailer Truck	5 axles	40	24	16.5	
Tractor Trailer Truck	6 axles	41	27	16.5	
Close Coupled Trailer	Various	40	26	18.75	

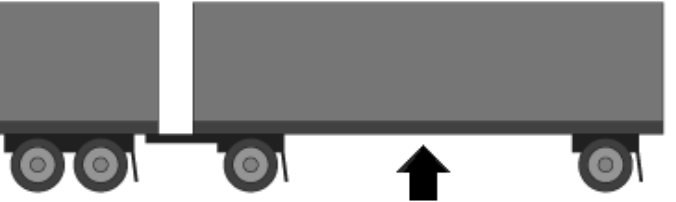
Cargo Vehicles Sizes

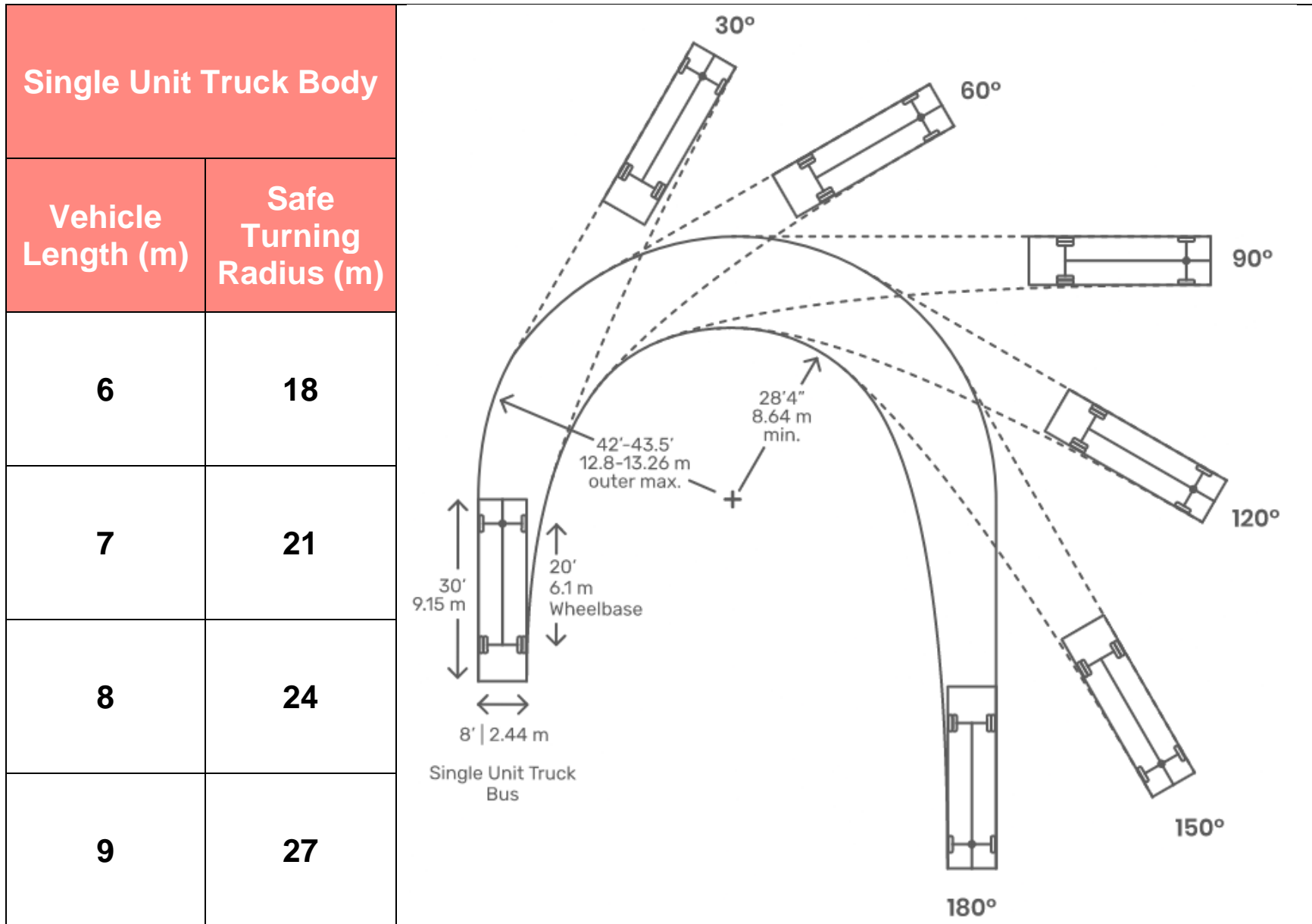

Cargo Vehicles Sizes

