

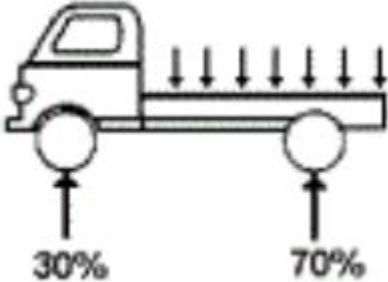

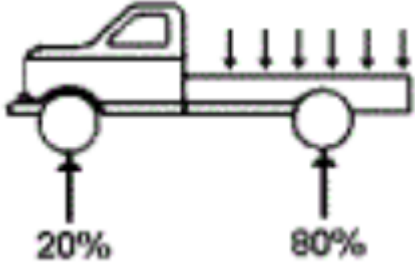

Cargo Vehicle Loading Guidance

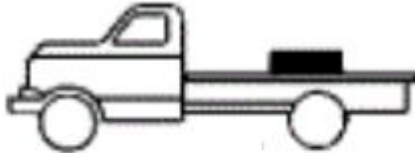

Weight distribution per truck body type

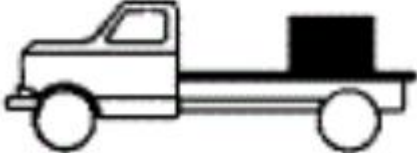
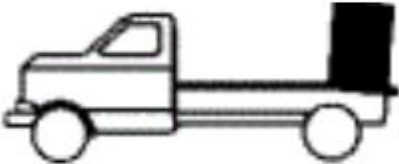
Cab Over Engine Truck	Conventional Truck
	

Loading procedures for conventional and cab over engine trucks



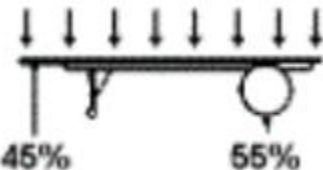

Correct Loading	Incorrect Loading
	
	
	

Weight distribution per truck body type

Trailer and Tractor Trailer Truck				
				

Cargo Vehicle Loading Guidance



Loading procedures for trucks with tractor trailers

Correct Loading	Incorrect Loading
	
	
	

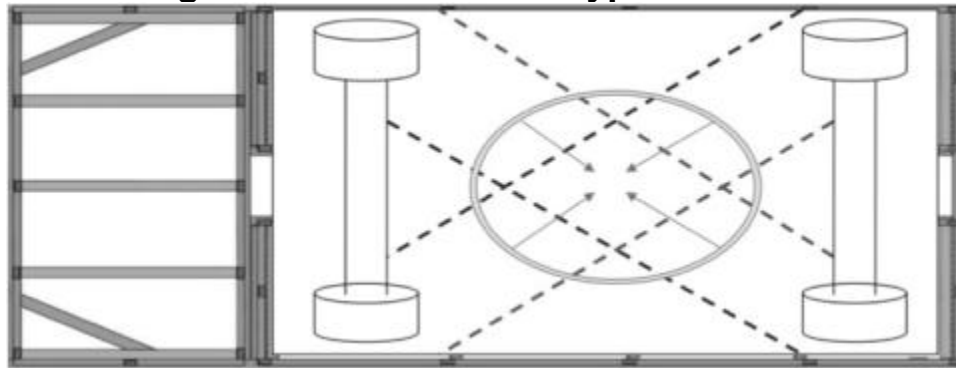
Weight distribution for all types of vehicles



Loading procedures for all types of vehicles

Correct Loading	Incorrect Loading
	

Cargo Vehicle Loading Guidance

Cargo Tie-Downs

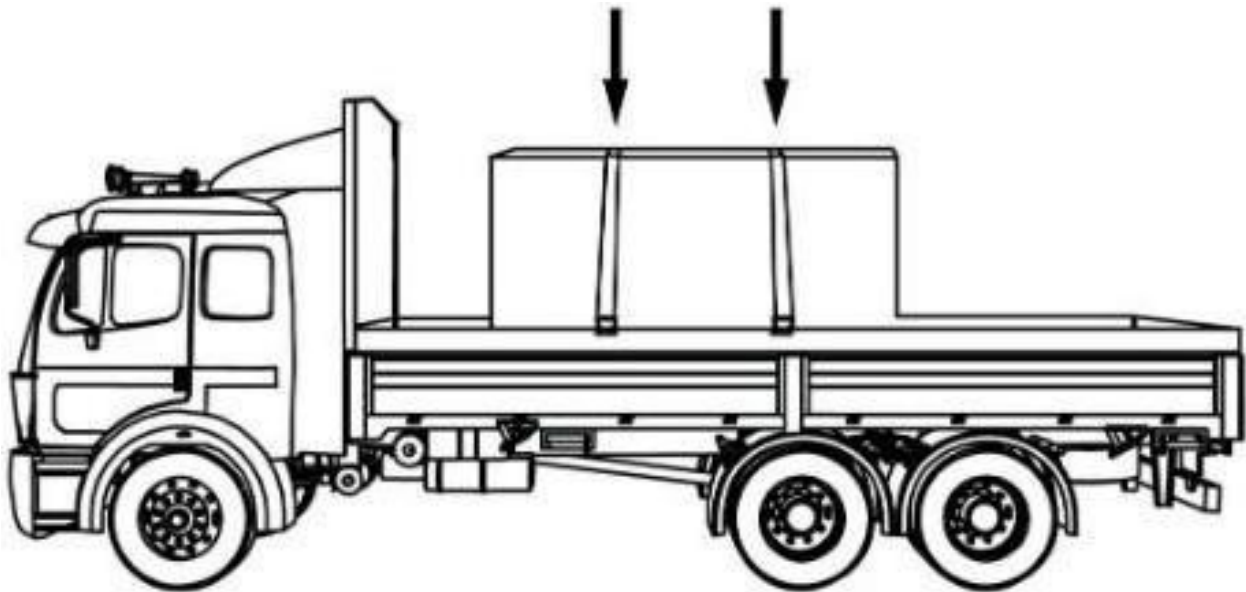

Number of Tie-Downs	Length of Load	Weight of Load
1	Shorter than 1.5 meters	Less than 500 kg
2	Shorter than 1.5 meters	Greater than 500 kg
2	Longer than 1.5 meters but shorter than 3 meters	-
3	Longer than 3 meters but shorter than 6 meters	-
4	Longer than 6 meters but shorter than 9 meters	-
4 (at least)	-	Greater than 4,500
5+	Additional tie-down for every additional 3 meters gained after 9 meters	

Working Load Limit (WLL) in Kilograms (kgs) per Grade and Chain Size					
Chain Size (cm)	Grade 30	Grade 43	Grade 70	Grade 80	Grade 100
0.6	500	1,100	1,400	1,500	1,850
0.8	900	1,800	2,200	2,100	2,600
0.95	1,200	2,550	3,000	3,200	4,000
1.1	1,600	3,200	3,900	-	-
1.25	1,900	4,000	5,000	5,400	6,700
1.6	3,150	5,900	7,200	8,250	10,300

