











## Tailles des véhicules de fret

Type	Essieux	Poids brut maximal (tonnes)	*Charge utile estimée (tonnes)	Longueur totale caractéristique de la carrosserie (mètres)	Carrosserie
Camion à unité simple	2 essieux /4 roues	3,5	1	Diverse	
Camion à unité simple	2 essieux /6 roues	7,5	3,5	Diverse	 
Camion à unité simple	2 essieux /6 roues	18,8	12	12	
Camion à unité simple	3 essieux	26	18	12	
Camion à unité simple	4 essieux	36	25	12	

## Tailles des véhicules de fret

Type	Essieux	Poids brut maximal (tonnes)	*Charge utile estimée (tonnes)	Longueur totale caractéristique de la carrosserie (mètres)	Carrosserie
Camion à tracteur-remorque	3 essieux	26	18	16.5	
Camion à tracteur-remorque	4 essieux	38	24	16.5	
Camion à tracteur-remorque	5 essieux	40	24	16.5	
Camion à tracteur-remorque	6 essieux	41	27	16.5	
Remorque à attelage court	Divers	40	26	18,75	

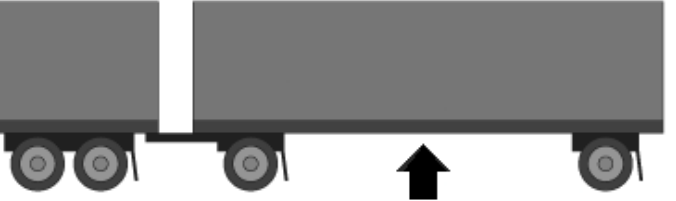
# Tailles des véhicules de fret

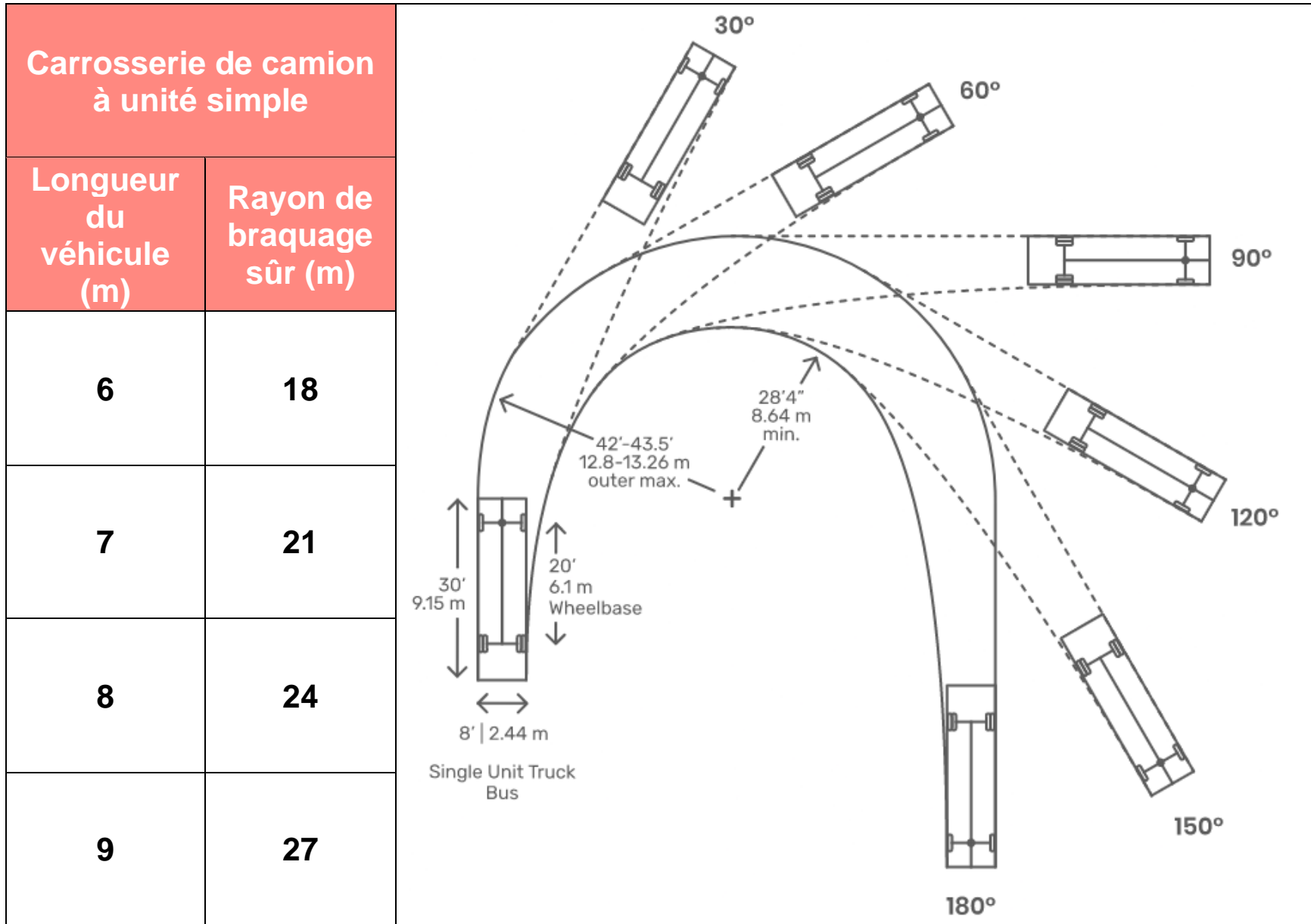

## Tailles des véhicules de fret

