

# Logistics Assessments and Planning

## Common Terms in Assessments

**Primary Data** New data collected directly from the field, through direct observation, key informant interviews, community group discussions and/or other tools.

---

**Secondary Data** Existing data that was gathered previously or provided by other sources.

---

**Indicator** A quantitative or qualitative variable that provides a simple and reliable basis for assessing achievement, change or performance.

---

**Vulnerability** The conditions determined by physical, social, economic, environmental and political factors or processes which increase the susceptibility of a community to the impact of shocks/hazards.

---

**Capacity** The resources of individuals, households, communities, institutions and nations to resist the impact of a hazard.

---

**Coping Mechanism** The adapted/unusual strategies that people or communities develop as a way of living through difficult times.

---

**Resilience** The ability to reduce, prepare for, resist and recover from shocks/hazards.

---

**Bias** The perceptions based on cultural background, experience, professional training and many other factors that people have and could disfigure a fact. Every organisation or person is susceptible to bias in some form.

---

**Analysis** The process of turning the data gathered during an assessment into useful information to guide appropriate decisions.

---

## Overview of Assessments in the Humanitarian Context

*"Assessment is a vital component of the response planning and implementation. It provides the information on which the response is designed and adapted. While good information does not guarantee a good response, poor information almost certainly guarantees a bad one."* [UNDAC, 2006 \(Disaster Assessment\)](#)

An accurate assessment depends on thorough planning, design and preparation. Under normal circumstances, the means of collecting and analysing the necessary data and information should be established as part of an organisation's pre-disaster planning. Preparedness ensures no time is lost revising procedures or questionnaires when the disaster hits.

Assessments enable logisticians to understand the impact of a disaster on the environment, how it affects populations, and how the logistics services should be provided. The findings from logistics assessments are critical in enabling appropriate decision making, planning and organisation for effective disaster response. However, logistics or any other functional unit cannot act as silos – every functional unit needs to complete its responsibilities in line with every other unit. This guide is focused on logistics and operational assessments, but will make reference to, explain and use concepts from the programmatic perspective. Logisticians need to have some knowledge and be able to use and discuss these concepts for a comprehensive and accurate assessment.

## **Definition**

An assessment is a planned exercise to gather, analyse and disseminate information about the outcome of an event or a remarkable contextual change. Its aim is to provide accurate recommendations that will allow the decision-makers to tackle or alleviate the undesirable effects of an event in a timely and efficient manner.

An assessment is performed to understand a situation in order to identify problems, their sources and possible consequences. The primary purpose of the assessment process is to determine not only whether an intervention is required, but also the nature and extent of the intervention.

## **Assessments by Purpose**

There may be different scopes when initiating an assessment, however, they are all related and aim to gather information that can shed some light on specific questions that humanitarian organisations have. Normally individual assessments are interconnected and it is common that while conducting one assessment, information gaps are identified that lead to another assessment to collect information about other topics. Experts in logistics tend to intervene in most assessments carried out by an organisation, providing information on the means, transport, accommodation, communication, safety, and other logistics related components that are required for a successful programme. Sector experts will also conduct their own independent assessments.

Common areas of assessment include:

### **Context Assessment**

The political and social background, and major events or cultural changes within a specified geographical area. Some context assessment can function as forecasts as well, identifying the likelihood of future developments.

---

---

Needs can be analysed from several perspectives:

**Needs  
Assessment**

- Technical assessments focused on programmatic matters that identify the main humanitarian needs.
- Operational assessments focused on the feasibility and possible constraints of programmes.

---

**Risk  
Assessment**

Assess interventions and the different threats, including: operational, reputational, safety and security and others.

---

**Capacities  
Assessment**

Internal and external capacity assessment inform humanitarian organisations ability to respond to an intervention.

- Internally – An organisations’ own limitations and the feasibility of the intervention.
- Externally – Resources available in a specific context, such as airport/seaport capacities, roads, transport means, internet connectivity or energy solutions.

---

**Stakeholders  
Assessment**

Assessment of different stakeholders, especially decision-makers and (if possible) the communities who will be impacted by the assessment; government, authorities, donors, humanitarian coordination bodies, International or national NGOs, heads of households, and any other parties involved in the intervention.

---

## Assessment Types

### Assessment Classification

One common humanitarian classification is the Inter-Agency Standing Committee (IASC) emergency phases. Each phase has its own particularities and priorities that prompt assessments to look for different answers and use different dedicated tools.

Note that in emergency situations, processes are intentionally shortened to speed up and facilitate immediate response. Assessments done during the recovery phase or in the development project may have other timelines, thoroughness and use other tools.

#### Initial

An initial assessment is the one performed in the first hours following a disaster, usually within the first 72 hours. The intention of an initial assessment provides a quick overview of the situation in a moment when there are more questions than answers. An initial assessment should not be confused with a detailed situation report, but only regarded as a highlight of the main facts and gaps in the information.

#### Initial Emergency Assessment:

Purpose	Time	Access to information sources	Typical information sources	Importance of assumptions	Type of assessment team
First impact evaluation of the crisis.	Within the <b>first 72 hours</b> .	<b>Very Limited:</b> Movements are usually restricted and communications not always functioning.	Relies on previous networking, coordination groups and official sources if any.	<b>Very high:</b> Few things are confirmed, assumptions must be made based on previous experience	Preferably a representative with experience in emergencies.

Adapted from IFRC, [Guidelines for assessment in emergencies](#) & IASC, *Classification of emergency phase*.

## Rapid

Guided by the initial assessment and incorporating the new developments, rapid assessments are generally produced within the first two weeks of the emergency. Rapid assessments provide information about the needs, possible intervention strategies and resource requirements. They also comprise situational, resource, and needs assessment in the early, critical stage of a disaster and are intended to determine the type of immediate relief response needed. This assessment can be conducted internally or, as a component of a general assessment format (i.e. [Multi-Cluster/Sector Initial Rapid Assessment \(MIRA\)](#)) as a coordinated effort among different partners.

Rapid assessments aim to identify:

- The impact a disaster has had on a society and its infrastructure, and the ability of that society to cope with changes.
- The most vulnerable segments of the population that might need to be targeted for assistance.
- The level of response by the affected country, its internal capacity to cope with the situation, and the level of response from the international community.
- The most urgent relief needs and potential methods of meeting them most effectively.
- Coordination mechanisms.
- Significant political, cultural, and logistical constraints.

Rapid assessments also seek to:

- Make recommendations which define and set priorities for actions and resources needed for immediate response.
- Highlight special concerns regarding the development of the situation.
- Draw attention to geographical areas/substantive sectors needing in-depth assessment.

## Rapid Assessment:

Purpose	Time	Access to information sources	Typical information sources	Importance of assumptions	Type of assessment team
Immediate response / lifesaving activities.	Maximum <b>two weeks</b> after the crisis.	<b>Limited:</b> Security and/or safety can limit movement and access to people as well.	Secondary information, local services (health, water, etc.), NGOs, government, affected population/ household partners and close providers.	<b>High:</b> Insufficient time to verify all the information. Situation is still volatile.	Experienced generalist, with previous exposure to emergencies.

Adapted from IFRC, [Guidelines for assessment in emergencies](#) & IASC, *Classification of emergency phase*.

## In-Depth

An in-depth assessment should be conducted following the initial and rapid assessment only where information gaps have been identified, where further information is needed to inform programme decision-making, and to measure programme outcomes or for advocacy purposes. Initial and rapid assessments provide the basis for subsequent in-depth assessments that deepen (but do not repeat) earlier assessment findings. During an in-depth assessment, it is important to focus on the situational changes before and after the disaster.

Each in-depth assessment will be unique, taking into account the individual circumstances and relevant factors, the identified gaps and the actual information needs of the organisation. Please reference the [Logistics Assessment](#) section of this guide for logistics related information.

### In-Depth Assessment:

Purpose	Time	Access to information sources	Typical information sources	Importance of assumptions	Type of assessment team
Medium term operational plan.	Less than one month after the crisis and/or each time is considered needed.	<b>Commonly Accessible:</b> Possibility to visit enough locations and interview a full range of informants.	Secondary information, and primary information gathered through a full range of informants.	<b>Low:</b> Sufficient time to interview full range of informants. Coordination with partners is mandatory to avoid duplication and ensure the reliability of the data collected.	Generalist, possibly supported by <i>specialists</i> .

Adapted from IFRC, [Guidelines for assessment in emergencies](#) & IASC, *Classification of emergency phase*.

## Continual

It is important to continue different assessments as needed. Continual assessment involves regularly updating information on the situation and seeking relevant feedback from the beneficiaries in order to facilitate decision-making on long-term activities. Effective continual assessments help to spot changes when they occur.

### Continual Assessment:

Purpose	Time	Access to information sources	Typical information sources	Importance of assumptions	Type of assessment team
Evaluations, monitoring and research.	Information collected regularly throughout the operational period.	Full normal access.	Primary and secondary information gathered through selected informants, based on indicators, with a standardised and planned exercise generally conducted by the organisation's staff.	<b>Medium:</b> Assumptions based on indicators and informants, but these can be verified from other sources.	Organisation staff during the normal activities development.

Adapted from IFRC, [Guidelines for assessment in emergencies](#) & IASC, *Classification of emergency phase*.

## Information Gathering Methods

A standard methodology to collect the data and/or manage the information obtained through the assessment is not only encouraged, an assessment won't work without standard inputs. Deciding what information is needed and how the data will be collected is crucial to achieving the assessment objectives. Indicators should be selected not on the basis of the organisation's interests and capabilities but on the basis of needs on the ground in order to design the most appropriate intervention.

Data can be qualitative or quantitative - both are needed, but the way they are collected differs. While gathering quantitative numbers and statistics is easier and provides figures that build assumptions, qualitative data requires a deeper understanding of the context, time to get find the appropriate sources, and staff trained to extract and analyse the information.

Data collection methods:

### Direct Observation

Direct observation is useful for cross-checking formal and informal information or reports. Informal discussions are usually the most straightforward approach to assessing infrastructure and logistics.

---

### Surveys

A survey is a series of standard questions asked of a predefined group of respondents drawn from a representative sample of the population. Surveys usually involve questionnaires that could include quantitative or qualitative questions and can be carried out remotely through the internet or phone. It is important to carefully design the questions and sampling method with the goal of seeking reality and not just confirm the organisations' assumptions.

---

### Interviews

Interviews are a powerful tool, however good judgement will be needed to decide what sort of information the informant can usefully provide. It is crucial to select the key informants who have specific knowledge about one topic and determine the best approach to address them. While individual interviews represent the quickest way to obtain technical information and allow individuals to talk about sensitive issues, group interviews promote interaction among people by encouraging an atmosphere of constructive debate.

---

## Assessment Cycle

“ A quick response to obviously urgent needs must never be delayed because a comprehensive assessment has not yet been completed” (UNHCR handbook for emergencies).

The assessment cycle is a conceptual tool that helps to better define the different stages of an assessment and at the same time emphasises the idea of a continual process. The final objective is to provide decision makers with reliable, accurate and valuable information to guide their decisions. The process is cyclical and responds to 5 phases.

1. Prepare
2. Design
3. Implement
4. Analyse
5. Share

## Prepare

The preparedness phase ideally starts well before the emergency strikes by defining assessment procedures and policies that fit with the organisation's contingency plans and programme planning. The assessment plan should explain how the organisation will carry out the assessment from start to finish, what the different parts of the organisation are responsible for, and how it will balance cost, speed and quality.

- Prior to the emergency: Review existing tools, mechanisms, and lessons learned. Update and trim tools if necessary, with enough time to reflect and adjust them appropriately.
- During and after the emergency: define how the organisation is going to intervene in and what value it will add to the response.

Planning an assessment involves:

- Identifying end users of the assessment information (i.e., program staff, donors, etc.) and their respective needs (i.e., budgets, programming, planning, etc.)
- Setting the objectives of the assessment.
- Establishing terms of reference for the logistics assessment team.

- Selecting team members.
- Identifying and/or preparing the assessment tools and pilot testing them.
- Mobilising resources to facilitate the assessment - staff, vehicles, computers, etc.
- Agreeing on reporting format.

## Design

Assessment designs will vary in different contexts - a single methodology that meets every information need in every situation will not exist. Every design has to start with the basic facts, including information about; where (locations affected), who (groups in need) and what (sectors that require action), and should be designed in a way that enables organisations to make specific decisions.

An assessment design has to be realistic, manageable within the existing capacities, and balance the cost of data collection against the benefit of having that information. The first step in design is reviewing existing secondary data - If there are significant gaps or specific questions to be answered, an assessment may need to be launched to collect primary data.

The assessment process should not compromise the protection and privacy needs of the affected population. The [Sphere for Assessment guide](#) highlights two elements of the principle, based on the humanitarian core concept of do no harm:

- “
1. The form of humanitarian assistance and the environment in which it is provided do not further expose people to physical hazards, violence or other rights abuse.
  2. Humanitarian agencies manage sensitive information in a way that does not jeopardise the security of the informants or those who may be identifiable from the information.

## Implement

Assessment implementation requires keeping objectives and deliverables clear while measuring the assessment progress continuously. While it is important to follow a plan, several modifications to the assessment plan may occur due to context or internal developments. The process should be standardised, transparent and clearly documented process to recognise possible flaws.

The more qualified and experienced an assessment team is, the more accurate and reliable the assessment findings will be. Standard Operating Procedures (SOPs) should be agreed upon with key stakeholders, and in accordance with the plan. SOPs describe the roles and responsibilities of team members, the team's management lines and support functions, and clearly identify team leaders.

## Analyse

Assessment analysis involves the combination of available information and its interpretation. An analysis should identify patterns, gaps and concrete facts, and provide solid arguments based on cross-checked evidence compiled through a specific methodology by a professional assessment team.

The complex and unpredictable nature of humanitarian emergencies, combined with the limited availability of data, makes precision and accuracy difficult. It is essential to clarify which data the analysis is based on and the source of that data. It is important to be honest about



gaps in the data and seek explanations for those gaps, such as lack of access, resources, or others.

When possible, the analysis should also identify gaps in capacity: human resources, aid materials, logistics capabilities, coping strategies, and more. What resources exist to meet the needs identified, and what additional resources are still needed?

## Sharing Results

Assessment findings, conclusions and data should be shared internally and externally.

- Internally, to allow decision-makers to guide their actions and other potentially interested colleagues.
- Externally, to assist others in their work, contribute to the overall baseline data available and increase the transparency of the response.

It is important to make the findings available to peers from other organisations, coordinators, government bodies, clusters, local and national authorities, and the affected communities.

Assessment findings are usually presented in the form of an “assessment report” that should fulfil the following criteria:

- Be clear, concise and relevant - as little writing as possible but as much as needed to communicate the findings.
- Enable users to identify priorities for action.
- Describe their methodology to demonstrate the reliability of data.
- Acknowledge assumptions, limitations, biases and gaps honestly.
- Enable a comparative analysis if required.
- Follow global humanitarian protocols which are technically compatible with other agencies' data.
- The frequency of data-sharing is context-specific but should be as prompt as possible.

Every report includes basically three major components

1. Findings
2. Analysis of those findings
3. Methodology followed to collect and analysis the data.

However, reports are not the only way to communicate findings; different users will require different formats and details. Briefing notes, maps, slides presentations or other formats that could meet the target audience's expectations may be required.

The findings should be shared widely and quickly where security and safety concerns permit. Once the information is made public, it can compromise the situation of the affected population, especially in conflict areas or tense situations. For these reasons, information products from an assessment (reports, maps or other outputs) should be prepared with sensitivity to protection issues.

## Logistics Assessment

Logisticians should try to plan ahead, having as much necessary information as possible before the full intervention scope is finalised. This may include being able to explain the times and costs of an intervention, and propose operational solutions. The main objectives of logistics assessment are:

- Gather, analyse and disseminate logistics related data and information in relation to the impact of a disaster
- Use that information to facilitate informed operational decisions making regarding feasibility of activities and proposing efficient solutions - including costs and times - to enact them.

While a logistics assessment determines the extent of the impact, it is also used to plan logistical needs.

A logistician may need to look for information on some of the following subjects.

***Identify impacts and infrastructure functionality (facts):***

<b>Area of Assessment</b>	<b>Template</b>	<b>Expected Outcome</b>
<b>Airport</b>	<a href="#">Download</a>	Establish accurate and comprehensive information about the feasibility of air transport.
<b>Seaport</b>	<a href="#">Download</a>	Establish accurate and comprehensive information about the seaports capacities.
<b>Waterways and River</b>	<a href="#">Download</a>	Identify the different options on waterway transport, capacities and possible challenges.
<b>Road</b>	<a href="#">Download</a>	Identify capacity of surface road movement options, the accesses actual status and possible secondary routes.
<b>Rail</b>	<a href="#">Download</a>	Establish accurate and comprehensive information about the rail route capacities.
<b>Customs</b>	<a href="#">Download</a>	Understand requirements and limitations for importation of emergency relief supplies.

***Clarify for operational purposes (needs):***

<b>Area of Assessment</b>	<b>Template</b>	<b>Expected Outcome</b>
<b>Warehouse</b>	<a href="#">Download</a>	Gather information about the possible storage options, and analyse their characteristics in support of programmatic objectives.
<b>Premises</b>	<a href="#">Download</a>	Gather information about the possible living and working facility options and analyse their characteristics to match organisational needs.
<b>Procurement</b>	<a href="#">Download</a>	Gather and analyse information about the context where the procurement activities will take place and the details about the actors involved.
<b>Fuel</b>	<a href="#">Download</a>	Gather and analyse information about fuel availability in the context of operation.

## Logistics Support to Project Cycle

A response can only be successful if programme and operational needs are fully understood and addressed. The key to a good project is an integrated collaborative planning process across functions.

Logistics personnel are frequently not adequately involved in all stages of a project. The contribution that logistics professionals can have in each stage is not only crucial to determine the feasibility of the project, but make significant contributions to the effectiveness and efficiency of the intervention.

### Programming

---

The programming phase defines an organisation's position in a country, its objectives and capabilities, its connections with other stakeholders and partners, and with the community it pretends to support.

Poor programming can severely limit the ability to implement a project and have a negative impact on the overall response to the affected populations.

#### ***Areas of Logistics Support:***

- Assess logistics capacities in the area or region: geography, population, urban / rural areas, roads, infrastructures, etc.
  - Collect information on context and safety, as well as maps of the area.
  - Initiate a market analysis.
- 

### Identification

---

---

The purpose of the identification phase is **Areas of Logistics Support:**

to analyse the problems faced by the project's target population and identify possible alternatives to address them. Each organisation has its own procedures and tools.

It is important to pay attention to infrastructure, safety and weather conditions throughout the year. Policies and procedures may be revised or adjusted to national laws, especially contracts with providers. The OECD has developed a [Methodology for Assessing Procurement Systems \(MAPS\)](#) that takes into account qualitative and quantitative indicators, along with gaps and findings to make recommendations regarding the specific market assessed. The Logistics Cluster also produces assessment information using the [Logistics Capacity Assessment \(LCA\)](#).

- Identify and establish contact with competent authorities and possible collaborators in the intervention area, such as suppliers, carriers, customs agents, etc.
- Provide logistical support to the evaluation teams, making available means of transport, communication and accommodation, among others.
- Provide the necessary access information to the assessment teams: maps, security, geographic, etc. gathered in the previous phase.
- Provide information on roads / landing strips and transportation for goods and personnel.
- Support a possible supply chain strategy, including storage, order management, and identifying origin of materials.
- Conduct market surveys, including local and regional.
- Establish communications using existing and appropriate equipment or services already in the area.
- Assess infrastructures, including what is available or what needs to be built or rehabilitated
- Assess capacity and availability of qualified labour.
- Identify all associated costs.

---

## Formulation

The formulation phase is defined as the phase in which the action is planned, being a crucial moment in the supply chain. Logistics participation in the formulation phase of any project phase is crucial. Logistics informs and provides the safest and most efficient way to establish the project, assuring its feasibility and sustainability. A procurement plan and budget must be prepared based on planned project activities, including the costs and delivery times for the materials and services that may be required are established into it.

The most commonly used tool for project formulation is the logical framework matrix. The matrix establishes logical links between the necessary resources to carry out the planned activities that will allow the expected results drive to achieve the intervention objectives.

**Areas of Logistics Support:**

- Understand the project aims and activities to achieve them and analyse its feasibility and costs or propose adjustments.
  - Define the logistics needs (at the level of storage, purchasing management, transport of goods and people, equipment) and estimate their costs.
  - Understand the donor rules correctly, adhere to the intervention to them or advance possible constraints or request changes where applicable.
-

## Funding

---

The funding phase is when organisations obtain financial resources to run a project. Funding needs will be based on budgets, which must include all the expenses derived directly or indirectly from the execution of the project. The main categories reflected in them are generally, personnel, travel, equipment, supplies (programme inputs), support and indirect costs. A procurement plan will be the basis for calculating the costs of the products or services and the logistics cost of making the project operational.

Institutional donors usually require a project proposal, which includes a detailed budget. Donor agreements are usually governed by a contract, and donor funds cannot be used indiscriminately – they must be used in a controlled and optimised way, and in compliance specific rules regarding the management of both funds and the materials, goods, services and properties (bought or rented) financed with their funds.

- Areas of Logistics Support:**
- The costs of the inputs and services necessary for the implementation of the project.
  - The costs of acquisition, operation and maintenance of communication equipment.
  - The costs of transporting personnel and goods.
  - The costs of hosting the equipment.
  - The costs derived from security management.
  - The estimated depreciation of fixed assets.

---

## Implementation

The implementation phase is when projects are actually carried out. The actual progress of the activities is monitored and contrasted with the initially planned progress. Monitoring Key Performance Indicators (KPIs), such as the cost of maintenance or deliver timelines can help ensure adequate fulfilment of planned projects.

**Areas of Logistics Support:**

- Updating procurement plan and supply plan information.
- Managing procurement.
- Monitoring compliance with donor rules.
- Budget and spending forecasts.
- Track maintenance and transportation costs.

---

## Evaluation

---

Internal evaluation of projects allows for measuring objectives and identifying problems. Ideally evaluations should be done at the time of closing to facilitate the design of future projects or programmes. Some donors also require a final report at the end of a project.

**Areas of Logistics Support:**

- Documenting the procurement process.
  - Conducting market evaluation.
  - Conducting stock consumption analysis.
  - Supporting equipment management, including donation to third parties, assignment to other uses, or requests for exception.
  - conducting a lessons learned or after action review.
- 

## Assessment Tools and Resources

### Templates and Tools

[Sphere for Assessment Guide](#)

[TEMPLATE - Airport Airstrip Assessment Tool](#)

[TEMPLATE - Customs Assessment Tool](#)

[TEMPLATE - Fuel Assessment Tool](#)

[TEMPLATE - Office Premises Assessment Tool](#)

[TEMPLATE - Procurement Assessment Tool](#)

[TEMPLATE - Rail Assessment Tool](#)

[TEMPLATE - Road Assessment Tool](#)

[TEMPLATE - Seaports Assessment Tool](#)

[TEMPLATE - Warehouse Assessment Tool](#)

[TEMPLATE - Water Transport Assessment Tool](#)

### Sites and Resources

- [Sphere Project, Handbook \(2018\)](#)
- [CARE Emergency Toolkit: Logistics](#)
- [IFRC Rapid Emergency Needs Assessment Guideline](#)
- [ACAPS Needs Assessment Guidance and Tools](#)
- [Map Action](#)
- [Crisis Mappers](#)
- [Logistics Cluster - Logistics Capacity Assessments](#)
- [WFP Dataviz](#)
- [SPHERE, \(2015\). Sphere for Assessment](#)
- IASC, (2015). Multisector Initial Rapid Assessment (MIRA) guidance. [English](#), [French](#), [Spanish](#)
- [OCHA Assessment and Classification of Emergencies](#)
- [UNDAC, \(2006\). Disaster Assessment](#)
- [WFP, \(2002\). Emergency Field Operations Pocketbook](#)
- [UNHCR Handbook for Emergencies](#)
- [USAID \(2005\) Field operations Guide v4](#)

- [IOM Emergency Operations Manual](#)
- [UNICEF, Emergency Field Handbook](#)
- [NRC, \(2014\). Humanitarian Needs Assessment, the Good Enough Guide](#)
- [ACAPS, \(2013\). Severity and Priority, their measurements in rapid needs assessments](#)

## Procurement

It is common to see the procurement as a bottle neck and a time-consuming activity, usually associated with delays and strict bureaucracy. However, procurement activities can be agile and practical if agencies understand the roll that procurement plays, why it exists, what the guiding principles are, and how to manage procedures. Through procurement activities agencies acquire the needed supplies and service to perform our daily organisational activities.

## Definition

“ Procurement is the process of identifying and obtaining goods and services. It includes sourcing, purchasing and covers all activities from identifying potential suppliers through to delivery from supplier to the users or beneficiary ("Global Logistics and Supply Chain Management," 2008).

It's important to note that procurement is not a single action but a process; a series of activities aimed at meeting the needs of humanitarian projects as well as our operation in general. This process is standardised in such a way that it can be replicated regardless of the place, time or context. At the same time the process should be flexible enough to encompass each of the different challenges that the purchasing manager faces.

The words purchase and procure are frequently used interchangeably; while common using the two words interchangeably is not necessarily accurate. Purchasing is just a part of the procurement process, an important one, but only the specific function associated with the actual buying of goods and services from suppliers. For the sake of this guide, procurement and purchasing will be differentiated along these lines.

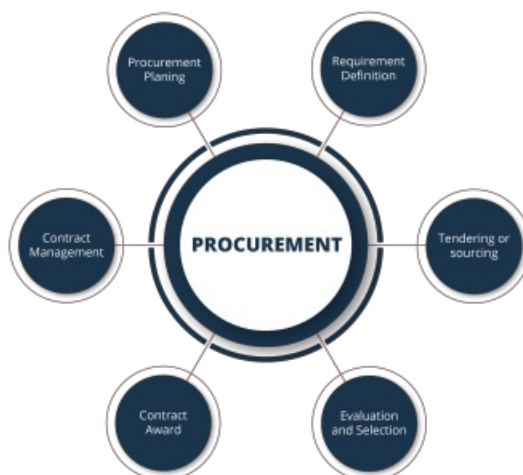

## Common Terms in Procurement

<b>Evaluation Committee/ Panel</b>	A committee made up of an odd number of members (at least three) with the necessary technical and administrative expertise to give an informed opinion on tenders or grant applications.
<b>BVM</b>	Short for "Best Value for Money"; the best combination available of monetary and non-monetary requirements that an organisation can get from its selection of suppliers.
<b>HPCs</b>	Short for "Humanitarian Procurement Centres". Are not-for-profit organisations specialised in the technical and commercial management of supplies and services necessary for the implementation of humanitarian actions. They can provide technical assistance in procurement or supply pre-established stocks, purchasing or logistics capacity
<b>ISO</b>	Short for "International Organisation for Standardisation". An independent entity that has been thinking and standardising the formulas that describes the best way of doing something.
<b>Certification</b>	Guarantee that a product and/or company has followed a quality process.
<b>Lead time</b>	The time between initiation of the acquisition of the goods and services up to the time of delivery.
<b>Market Analysis</b>	An essential component of context analysis, collecting information that will be useful to program the intervention and how to implement it.
<b>Market Research</b>	Activities and means to identify suppliers in a specific market.
<b>Negotiated Procedure</b>	Procedure without prior publication of a procurement notice, in which the Contracting Authority consults the candidate or candidates of its choice and negotiates the terms of the contract with one or more of them.



---

**Procurement** The process of identifying and obtaining goods and services

---

**Purchase** The specific function associated with the actual buying of goods and services from suppliers.

---

**QA** Short for "Quality Assurance"; A procedure to ensure the quality of products or services by preventing mistakes and defects in manufactured products and avoiding problems when delivering products or services to beneficiaries.

---

**QC** Short for "Quality Control"; checks to ensure quality in a product or a service.

---

**Quality** All the elements and characteristics which constitute the product and which contribute to its compliance with the defined technical specifications.

---

**Sourcing** Identifying and working with appropriate suppliers.

---

**Services** Intellectual and non-intellectual services.

---

**Segregation of Duties** Principle by which must have more than one person to complete a procurement activity.

---

**TCO** Short for "Total Cost of Ownership"; Cost involved in buying and using a product over time.

---

**Tender Procedure** The overall process of putting a contract out for tender, starting with the publication of a procurement notice and ending with the award of the tendered contract.

---

**Works** The design and/or the execution of a rehabilitation, construction, etc. in accordance with the previously specified requirements.

---

# Procurement Principles

## Procurement Principles in the Humanitarian Context

There are certain principles that govern the way in which a procurement activity is carried out. These principles are not random or chosen by chance; they are the result experience. Humanitarian actors can have a large financial impact on the contexts in which they work, and procurement plays a major role in that it has to do with the exchange of money, selection of providers, distributions in insecure contexts, and constant exposure to various risks.

A general series of principles have been developed that govern procurement actions, to which the procuring entities are strongly advised to adhere. The ultimate goal of these principles enacting an economic and efficient intervention with the best quality-price ratio.

### Best Value for Money

“ Best Value for Money (BVM) refers to the best combination available of monetary and non-monetary requirements that an organisation can get from its selection of suppliers. It does not mean to achieve the cheapest offer but to balance the attributes such as quality and availability according to the organisation needs ([ULS Handbook](#)).

The combination BVM speaks of are cost, quality and sustainability that best meets the organisation's requirements.

- **Cost** is understood as costs of the entire life cycle of the product or service. Total Cost of Ownership (TCO) takes into consideration not only the price but all the cost involved in buying and using a product over time.
- **Quality** understood as sufficient specifications to meet the organisation requirements.
- **Sustainability**, taking into account the economic, social and environmental impacts.

Those responsible for procurement should look for the lowest overall cost to get the best return of investment.

### Competition

Supplier selection - and therefore the procurement of products and services - is based on a competitive process. That means that solicitation documents should be issued to several and different suppliers, enabling effective competition. Competition entails:

- Promoting a culture of neutral specifications (avoiding over/under-specification).
- Providing suppliers with adequate notification to ensure that there is sufficient time to participate in the procurement processes.
- Ensuring the comprehensive, impartial and timely evaluation of offers.

It is a good practice to give feedback to the non-successful bidders, explaining them the reasons for not being selected to allow them to improve their processes.

### Transparency

Purchases are part of the joint action of many actors - headquarters, project managers, technical services, field staff, suppliers and communities. It is key that each party know the processes associated with achieving procurement objectives. Procedures should be shared

both inside and outside the organisation to ensure that each person or group can understand and question. Transparency does not mean that a humanitarian organisation loses independence, but rather that it can reason the actions and clarify guiding principles used in the purchase of goods or services.

Transparency is also an important part of security management, since a perception of partiality or lack of transparency could lead to threats or increase risk for teams in the ground.

## Proportionality

It is strongly advised that control measures and procedures should increase proportional to the value the contract or procurement. The higher that value, the more measures, resources, and stricter procedures will be required. Inversely, if the value is reduced procedures should be more lax. This principle forms the base of different procurement procedures.

## Fairness

Humanitarian aid organisations are generally important economic actors in the places in which they operate, due to the high volume of products and services involved in humanitarian operations. Normally aid organisations operate in very small or disrupted markets, so it is advisable to pay attention to the market assessments and keep it in mind in each context analysis.

Humanitarian organisations need to be aware of the local market composition and the different involved actors. When designing and implementing interventions, organisations should assess and analyse local markets and supporting supply chains in order to facilitate their recovery. All potential suppliers have the same tools and information to compete fairly; agencies must be clear in their requirements and criteria applied to all awarded contracts.

## Segregation of Duties

*“ Segregation of duties is a core principle of internal control and must be preserved in all procurement actions. According to the principle of segregation of duties, no single individual or team shall control all the stages of procurement process (WFP Goods and Services Procurement Manual, 2020).*

For the sake of quality and control, segregating responsibilities during the purchase process helps not only to identify errors by adding review and oversight steps, but also limits the possibility of fraud. Having more than one person involved in the process also helps to protect those with procurement responsibilities from accusations.

A best practice might be the segregation of duties among persons with different points of view, knowledge and ideas. Decisions are more likely to be successful when everyone is informed and in agreement. The table below shows different examples on how to ensure the Segregation of duties:

<b>The person to:</b>	<b>Should not be the only person to:</b>
Request an article and/or fill the PR	Approve the Purchase Order (PO)
Execute the contracting/acquisition procedure	Approve the Purchase Order or the Contract / Framework Agreement

Select the supplier	Approve the Purchase Order or the Contract / Framework Agreement
Approve the Purchase Order (PO)	Receive the goods / services, e.g., Approve a Goods Receipt Note
Execute the contracting/acquisition procedure	Receive the goods / services, e.g., Approve a Goods Receipt Note
Receive the goods / services, e.g., Approve a Goods Receipt Note	Create payment request / Prepare Payment Package / Authorise payment

Source: Save the Children International. Procurement Manual 2.0 01.01.2020.

## Ethics

Humanitarian aid has evolved its own defacto code of conduct. This set of principles has led to the development of multiple norms, or even rules, that agencies observe while implementing programs. There are - for example - codes of conduct, which are understood and signed by all employees which may include rules that humanitarian staff:

- Do not use their authority or status for personal gain.
- Maintain a high level of integrity and ethics in business relationships.
- Use the resources and assets of the organisation responsibly.
- Do not accept personal gifts from suppliers or engage in any other anti-competitive conduct.
- Act and behave in a professional manner as representative of the organisation and donors, and avoids anything that could bring discredit to the organisation or donors.

When possible it is best practice to include ethical requirements in published tenders, and use ethical requirement compliance as part of the selection criteria. Frequently suppliers do not have standard certifications, nor are they used to complying with ethics standards, which is why it is important to conduct a good market analysis. It is also important to conduct regular visits to suppliers' premises to evaluate their ways of working.

## Standards, Protocols and Controls

Each organisation should establish controls to manage and react to misconduct. Applying standards and protocols in relevant ways and in specific operational contexts is an ongoing challenge for humanitarian organisations. These principles of action are usually understood as a guide, and may include the following:

- **Humanitarian responsibility** - "Do not harm" (prevention of negative impacts, we are guests, respect local cultures).
- **Protection of victims** - Presence with the victims as protection.
- **Collaboration with stakeholders (local, international)** -Exchange know-how, optimisation of resources, empowerment, sustainability.
- **Commitment to improve the education and training of teams (national staff) and beneficiaries.**
- **Prioritisation of the most vulnerable groups.**

- **Maximum beneficiary participation.**
- **Respect for the environment** - Environmentally friendly technical solutions, research and development, impact analysis, community awareness.
- **Integrated approach to interventions/Coordination with other organisations.**

To guide and enforce these principles, specific policies should be drafted, addressing each issue in depth, explaining the why and how, and establishing corrective measures. Among the most common internal policies are:

- **“Whistle-blower” Protection Policy:** Protection against retaliation for reporting misconduct and for cooperating with duly authorised audits and investigations.
- **Policy on Harassment, Sexual Harassment and Abuse of Authority:** ensuring that all its workplaces are free from abuse, offensive behaviour, harassment, abuse of authority and discrimination. This also includes promoting a work culture in which every employee understands, and is able to carry out, his/her personal responsibilities for maintaining the dignity of work colleagues.

It is not necessarily enough to ensure that these principles are respected internally; they have to be enforced in the relation with third parties. To facilitate this, it is common for contracts to include specific policies third parties should adhere to. Examples of these policies are:

- Anti-Fraud and anti-corruption policy.
- Prevention against child-labour.
- Prevention against modern slavery.
- Waste management best practices.
- Anti-terrorism.

These policies and feedback mechanisms may also be included or referenced in the Terms and Conditions (TC) attach to any PO, allowing the suppliers to understand their obligations and inform agencies about any potential problems.

## Conflicts of Interest

Conflict of Interest can be defined as any actual, perceived or potential incompatibility between an employee's private interests and either his/her official duties or the interests of the organisation. A conflict of interest may include, but it is not limited to:

- An employee, directly or indirectly, appears to benefit improperly from a procurement activity.
- A third-party benefits improperly from his/her association with an employee.
- Any person within an organisation holds a financial interest in an enterprise that engages in any business or transaction with the organisation.

Examples of Conflicts of Interest:

- Accepting gifts from individuals or external entities with which the organisation has a relationship, including vendors, consultants and governments.
- Accepting entertainment from individuals and organisations which seek to do business with the organisation or influence it.
- Supporting an external organisation through your work, major financial donations, or by lending your name or reputation to an effort.
- Using the reputation of the organisation for personal benefit.
- A direct financial or family relationship with individual or external entities with which the organisation has a relationship.

# Best Practices

Aid agencies are encouraged to introduce and follow best practices throughout the procurement process. A general table of accepted best practices can be seen below:

Ares of Best Practice	Example
<p><b>Individual Behaviour.</b></p>	<ul style="list-style-type: none"> <li>• Respect organisation’s rules and regulations</li> <li>• Always bear organisation’s interest in mind</li> <li>• Apply principles of professionalism, efficiency and integrity</li> <li>• When managing a contract, balance the need to get the supplier’ trust with the one of keeping distances</li> <li>• Refrain from sharing confidential information</li> <li>• Act in the interest of the organisation but taking into account rules and procedures</li> <li>• Try to understand the “spirit of the law” and what the rationale behind the rules is</li> <li>• Be alert about potential “red flags”</li> <li>• Openly discuss whenever facing difficulties</li> <li>• Share procurement knowledge within your unit</li> <li>• Increase the awareness of ethical values in your unit</li> <li>• Ensure compliance with correct procurement procedures.</li> <li>• Increase your knowledge of procurement rules and procedures</li> <li>• Be aware that there are many documents that might help you to deal with “grey areas”</li> <li>• Be sure to document and file any deviation from the correct rules</li> <li>• Set a good example</li> <li>• If in doubt: ask!</li> </ul>
<p><b>Working Practices with Suppliers.</b></p>	<ul style="list-style-type: none"> <li>• Business should be conducted during normal working hours</li> <li>• Meetings with suppliers should be with minimum two organisation staff members</li> <li>• Suppliers should not be invited to organisation staff offices but to the cafeteria or meeting room</li> <li>• Meetings should have an agenda and minutes</li> <li>• Ensure sufficient distance when working with suppliers, especially when the same one for many years</li> <li>• Make sure you are aware of relevant policies and how to apply organisation’s ethical principles in your work</li> </ul>
<p><b>Avoid excuses among team and employees.</b> Ethics is about doing the "right thing" even beyond the workplace. It is important to be vigilant and not relax working behaviour.</p>	<ul style="list-style-type: none"> <li>• “I have to cut corners to meet my goal.”</li> <li>• “I lack the time/resources to do what is right.”</li> <li>• “My peers expect me to act this way.”</li> <li>• “My superiors want results.”</li> <li>• “I don’t think it is really wrong or illegal.”</li> <li>• “Others would think that it is a good choice.”</li> <li>• “No one will ever know the difference.”</li> <li>• “I am afraid to do what I know is right.”</li> <li>• “This is how it has always been done.”</li> <li>• “Let’s be practical.”</li> </ul>

---

**Watch for Red Flags.** look for possible symptoms of unethical behaviour and watch out for.

- Deviations from correct procedures
  - Poor record keeping / Missing files
  - Excessive secrecy
  - Reluctance to delegate
  - Protective of certain suppliers
  - Resistance to audit
  - Unnecessary meetings with suppliers
  - Overcharging by the supplier
- 

## Procurement Planning

### Market Categories

The concept of "market categories" allows a more structured way of compiling and combining purchases due to their nature and specifics, and to ensure that the procurement principles are followed while facilitating the procurement process by establishing standards and tools. In addition, it is possible that the different market categories could have different thresholds. In general, there are four main categories or "markets" humanitarian organisations work with, however variations and additional categories can and do exist.

The goods or supplies category includes the purchase of tangible items and/or their interrelated sets. In general, a market is considered as goods/supplies when there is a transfer of ownership of tangible products.

A product is defined by two elements:

- Technical specification or detailed description (including images if necessary)
- Purchase Unit (Kg, Lt, piece, etc)

### Goods/Supplies

All the costs associated to production, preparation, installation, maintenance and disposal related to the purchased products (total cost of ownership), can be considered as part of goods market if the additional services have been procured, delivered and invoiced together and as long as these costs remain lower compared to the total purchase cost.

The typical purchases in the goods market are include food, tools, construction materials, office supplies, equipment, etc.

---

---

**Construction/Maintenance**

Construction/maintenance is a market category that includes the design of the work and/or its execution in accordance with the previously specified requirements.

Construction/maintenance procurement and monitoring procedures usually includes visiting the place where the works should be performed with potential contractors, allowing them to better understand what is needed and the requirements in order to make a more accurate offer. As the works usually takes time to be finalised, an execution timeline must to be included in the plans as well as moments where inspection visits have to be performed.

Common examples are; a building rehabilitation (in full or part), any kind of construction, road sections, etc.

---

**Services**

The services market category includes the intellectual and non-intellectual services that do not fit in goods and works markets definitions. Evaluations, technical assistance, or any other activity not involving the transfer of a tangible product are considered as a service.

Under this market its possible to hire the services of dispatchers, lawyers, consultants, translation services, transport, etc.

---

**Property/Rental**

Property/Rental markets refer to the rental of real state, whether land or buildings, regardless of their purpose. This market possesses certain characteristics that makes the sourcing and selection process slightly different from the other markets:

- There are no suppliers or provider but landlords.
- There is no transfer of ownership but right of use for a period of time.
- There are specific laws applying to property.

The complexity of the property market means it is difficult to measure two or more premises exactly by the same criteria. While there are some similar comparable aspects such as the location, the structure, the internal distribution, security considerations, makes the selection process more complex. Logistics personnel associated with procurement must evaluate the local market (actively) and choose the more economical option that fits the initial requisites as much as possible.

---

**Procurement Strategy**

Any procurement strategy must observe the core procurement principles established by an organisation and should incorporate different procurement plans for programs or projects where needs are pre-identified. Agencies should know what, where and when supplies are needed and choose a supporting supply strategy, paying attention to the total cost of ownership (e.g., initial purchase, shipping, operation, maintenance and disposal costs), the special field conditions and the actual ability to acquire and deliver materials and services needed. If agencies do not approach procurement strategically, they run the risk of not being able to accommodate all needs, fail to comply with budgetary restrictions, and run financial,



reputational or even security risks.

A strategy has to be flexible and ready to be revised with changing conditions, changing requirements, or changes in the context surround the organisation. Each intervention must to have a separate procurement plan that reflects the minimum information on the anticipated needs, allowing:

- Improve sourcing and thereby increase competition.
- Mitigate the risk of redundancy, reducing transaction costs and prices through the consolidation of procurement actions.
- Increase the efficient use of resources by avoiding last minute actions.
- Prevent non-compliance with regulations, rules and procedures due to oversight or time constraints.

Procurement plans are the basis of any procurement process - they must be prepared before the start of any action, program or project, and must be based on analysis of budget, beneficiary numbers and activities. The exercise is a common effort among all the participants, including project and programme staff, logistics personnel involved in procurement, and finance staff who control budgets. The plan should formalise the following details:

- Description of goods/services to be procured.
- Estimated costs and quantities of the needed goods and services.
- Categories of goods and services.
- Solicitation methods.
- Target delivery dates (timeline/schedule).

It is possible that aid organisations cannot not foresee all needs throughout the project duration, and that any given plan may undergo major or minor modifications due the changing conditions. There are usually recurring requirements that can be anticipated, however, and there are some reasonable estimates that can be based on past experiences from where planners can extract information.

It is key to clearly define the requirements for every needed good or service at the planning phase. This enables persons enacting procurement to better understand the function, performance and technical specifications that will be required to cover the requester needs, how to determine the best solution to fit them, and how to establish the evaluation criteria to assure the quality standards.

## Documentation

### Common Documents in Procurement

The following documents can have different names in each organisation.

Procurement Process Step	Acronym	Document's Name	Definition
	BOQ	Bill Of Quantities	A document used in tendering in the construction industry in which materials, parts, and labour (and their costs) are itemised.

<b>Procurement Process Step</b>	<b>Acronym</b>	<b>Document's Name</b>	<b>Definition</b>
	<b>EOI</b>	<b>Request for Expression Of Interest</b>	A formal notification aimed at determining the capacity, interest, and availability of potential suppliers in the market to deliver the goods and services required.
	<b>RFI</b>	<b>Request For Information</b>	Is used to supplement the writing of the technical annexes to the solicitation documents and ensure those are accurate and have a comprehensive set of requirements.
	<b>PR</b>	<b>Purchase Request</b>	The standard and official form to request a purchase.
<b>Requisition</b>	<b>SOW</b>	<b>Scope of Work</b>	<p>SOWs can be used for different contexts:</p> <ul style="list-style-type: none"> <li>• SOWs can be used in all types of civil, mechanical, electrical or other engineering/installation services for works, as well as the supply of construction materials and equipment included therein. It provides all information required to allow the contractor to undertake the works.</li> <li>• SOWs also are used for detailed product specifications, utilised when organisations need to be highly involved with the product development process, including detailed material specifications.</li> </ul>
	<b>TOR</b>	<b>Terms of Reference</b>	A description of the work to be performed, the level of quality and effort, the timeline and the deliverables, used to define the performance requirements for services that cannot easily quantified.
	-	<b>Technical Specifications</b>	A document drawn up by the contracting authority setting out its requirements and/or objectives in respect of the provision of supplies, specifying, where relevant, the methods and resources to be used and/or results to be achieved.
<b>Solicitation</b>	<b>RFQ</b>	<b>Request For Quotation</b>	A written request made to suppliers for the purchase of goods or services, up to a maximum value established by the organisation.
	<b>ITB</b>	<b>Invitation To Bid</b>	A letter sent to selected candidates in a restricted procedure or competitive negotiated procedure inviting them to submit a bid. This term is use interchangeably with "RFQ" in this guide.
	<b>RFP</b>	<b>Request For Proposal</b>	A written request made to suppliers for complex purchase exceeding the maximum value established by the organisation. This term is use interchangeably with "Tender Dossier" in this guide.
	-	<b>Tender Dossier</b>	The dossier compiled by the Contracting Authority and containing all the documents needed to prepare and submit a tender.
	<b>ET</b>	<b>Evaluation Table</b>	Tool aimed to compare the different bids received and present them in a Comparative Table.

<b>Procurement Evaluation Process Step</b>	<b>Acronym</b>	<b>Document's Name</b>	<b>Definition</b>
	-	<b>Tender Report</b>	Document where present every detail about a tender process, including a comparative table and a reasoned proposition to award the contract
	<b>PO</b>	<b>Purchase Order</b>	A financial commitment that confirms the purchase details (Units, quantity, price, delivery time and Location, etc), formalising the Order
	<b>TC</b>	<b>Terms and Conditions</b>	The applicable rules governing the purchase of a product, service or works.
<b>Ordering and Contracting</b>	-	<b>Contract</b>	Legally binding agreement between the organisation and the supplier. It defines the Terms and Conditions for the good and services provision, as well as the signatories related rights and obligations. (see Contracts).
	<b>LTA or FWA</b>	<b>Long-Term or Framework Agreement</b>	A contract concluded between a Contracting Authority and an economic operator for the purpose of laying down the essential terms governing a series of specific contracts to be awarded during a given period, in particular as regards the duration, subject, prices, conditions of performance and the quantities envisaged. ( see LTAs)
	<b>DN</b>	<b>Delivery note</b>	Documentary proof that the supplier commitments have been fulfilled.
<b>Reception</b>	<b>RN</b>	<b>Reception note</b>	Documentary evidence of the transfer of responsibility of a cargo.
	-	<b>Commercial Invoice</b>	A document that state the parties involved in the transaction, describe the goods purchased and indicate their value.

## Documentation Management

Each specific purchase will need to be in compliance with each organisation's own procurement procedures and donor requirements. Every procurement process must be justified and thoroughly documented, having its own dossier containing all the documents related to a procedure. A procurement dossier can be thought of as a set of documents that justifies the steps taken in a particular procedure. Not all dossiers will be the same in volume and complexity, but all dossiers should be preserved for later use.

A proper filing system ensures that records are properly maintained during a fixed period of time for internal and external use.

- **Internally** - An adequate filing system increases efficiency and reduces wasted time during the preparation of reports and audits. The appropriate file reflects the principles of the Organisation and provides Professionalism and Transparency.
- **Externally** - The organisation is responsible for justifying the acquisition, use and disposal of materials, services, equipment, etc. to donors.

A filing system has no value if the documents are not duly completed and signed. Only employees to whom such responsibility has been formally assigned should be authorised to

sign documents. Those employees must understand the meaning of their signature in terms of their responsibilities and consequences for the organisation. Files must be kept for months or years, depending on donor requirements or internal audit guidelines.

## Standardisation Tools

### Codes

Most of the forms handled by logistics personnel have or should have specific codes (references) that allow them to be connected and subsequently tracked. Typically, a form includes its own reference for easy identification, as well as one or more references to link it to the other documents. Forms are filed according to their references, and the proper use of references has a direct impact on the archive. When someone (internal or external) needs information about the history of our operations, the correct use references (encoding) facilitate access.

These codes might include information about the country, the office and the department requesting the purchase plus a running number.

As an example, a purchase requisition for the logistics team in Rome, might follow the below convention.

Unique Number	Document Type	Country	Sub-office	Department
<b>1234</b>	<b>PR</b>	<b>IT</b>	<b>RM</b>	<b>LOG</b>
	Purchase Requisition	"Italy"	"Rome"	"Logistics"

When written, the code might look like:

**"1234/PR/IT/RM/LOG"**

This short hand code will allow any person to quickly identify documents and know at least some level of information about the document. The order types of information are specific to the agency managing the files, however. Some agencies may wish to use the date as a unique code, while others may choose to use a running number sequence. Also - some agencies prefer to have unique number sequences for each document type (PR/PO) while others may want to have singular numbers that do not change throughout the different documents within the dossier. The need for each will be specific to individual agency's needs.

### Labelling

Large volumes and types of documentation are common in emergency response. Labelling each folder and/or box in the most harmonised way possible with the thought process of who will coming after the initial response phase is important. The common archiving approach allows documents to be tracked more easily, while also allowing sensitive files to be identified

faster in an emergency. All related folders must be clearly labelled and separated using a colour, number, or other identifiable pattern, and stored in a safe, dry and secure location. Electronic filing systems should match paper files.

## Procurement Process

In volatile context, with all the external and internal challenges and taking in consideration the capacity to impact the local market that the humanitarian aid has, is critical to have and implement standards over the whole process that could guide and ensure procurement principles are followed. Every coherent procurement process will have six basic steps.

1. Sourcing and Identifying Vendors
2. Product/Service Requisition
3. Solicitation
4. Evaluating and Awarding
5. Ordering and Contracting
6. Reception and Payment



## Sourcing and Identifying Vendors

Procurement actions are based in a fair and transparent competition among different suppliers. Some form of market research should be done in order to collect information about the desired product and the potential suppliers that could potentially provide it.

*“ Market research is used to identify suppliers, assist in the development of Technical Specifications, TORs and SOWs, ascertain freely available pricing information (e.g., company catalogues) and obtain information on available technology (WFP Goods and Services Procurement Manual, 2020).*

It is convenient to have a supplier database from which quotes are requested. If no such database exists, it is advisable to create one. A supplier database needs to be updated routinely, and agencies may look to platforms or sources of information such as:

- Specialized journals
- Chambers of Commerce
- Business meetings and seminars
- Professional associations
- External supplier rosters
- Online communities
- Yellow pages
- Search engine research
- Others

In the process of identifying suppliers, agencies may wish to follow a formal process. Many agencies issue official documents, including:

- Request for Information (RFI)
- Request for Expression of Interest (EOI)

These formal requests should be based on templates that will allow users to build a more accurate view of the product or service and their availability in the context of operation.

## Product and Service Requisition

Any procurement for goods or services should be built upon needs. Once the needs are identified measured and planned by a team or individual within an agency, they should be formally communicated to the organisation's procurement team, usually through a formally defined a Purchase Request specifying:

- The requesting unit.
- The requirements, including the criteria for evaluation.
- The quantity.
- The Estimated cost or the maximum authorised amount to be spent (If possible).
- The delivery date and location.
- Confirmation that funds are available.

A key component of any purchase requisition should be the inclusion of technical specifications. There are many ways for suppliers to define technical specification. These might include:

- |                       |  |
|-----------------------|--|
| <b>Physical Goods</b> | <ul style="list-style-type: none"> <li>● Photographs</li> <li>● Material components</li> <li>● Performance needs (example: storage space of a computer, volume of a bucket)</li> <li>● Quality standards (example: ISO)</li> </ul> |
|-----------------------|--|

- |                     |  |
|---------------------|--|
| <b>Construction</b> | <ul style="list-style-type: none"> <li>● Blueprints</li> <li>● Maps</li> <li>● Bill of materials / material construction components</li> </ul> |
|---------------------|--|

In other words, the requester should provide all information and fill out forms as agreed during planning. If a pre-plan was not done, the request may have some delays while the feasibility is assessed.

The PR is usually the standard and official form to request a purchase. The PR is where the different members involved in the procurement process combine and validate the details, turning requests into actual procurement:

- The requesting unit undertakes that all information included in the PR is accurate and sufficient. Attaching detailed specifications if necessary.
- The procuring unit undertakes to provide the requested goods or services as established in the PR respecting quality, price and lead time.
- The financial unit undertakes to release the available funds.

One of the best ways to assure that each request is well presented, understood and agreed among all the units involved in the process is to create a coordination space to do it. The usual coordination tool is the implementation of a recurrent meeting between requesters, heads of unit, and the procurement team where the requests can be discussed and validated.

## Solicitation

Once potential suppliers have been selected (or before launching an open bidding process), solicitation documents must be carefully prepared. The way offers are solicited and received impacts the rest of the process; there is an inverse and direct relationship between what is solicited and what is offered. Procurement teams will only choose from the options offered by the providers, but what is offered largely depends on how and what the providers have been asked to offer. Specifications of required products or services must be clear, and the terms of the requested bid must be well defined.

Supplier selection criteria must be established and communicated clearly and in advance to suppliers, ensuring equal treatment. It is important to take time to establish and/or understand the selection criteria since the supplier selection criteria cannot be modified or changed, once communicated to the suppliers.

The documents involved in the solicitation process can be different depending on the type of competition that applies (see [Procurement Procedures](#)) and the nature and complexity of the good and services being procure. It is important that all documentation contains details on procedural, technical, financial and contractual components, which suppliers must follow when submitting their offers. These documents are based on templates, customised to fit the specificity of the procedure undertaken and completed with the details applicable to each solicitation.

---

### **In general, any Solicitation document, no matter the procedure, will contain:**

---

#### ***What is Required***

- Depending on the nature:
  - **For goods;** Technical specifications or statement of work (SOW) (Functional, conformance and performance Specifications for products).
  - **For services;** Terms of Reference (TOR) (background, objectives, deliverables, standards to be met, performance evaluation method, timelines, etc.).
  - **For construction works or services;** Statement of works (SOW) shall provide all information required to allow the contractor to undertake the works (e.g., location, time schedules for the execution of the works, relevant information about the construction site and other technical requirements that are deemed necessary).
  - Quantities
- Expected Delivery Conditions; times, locations, Incoterms

---

#### ***Instruction to suppliers***

- Instructions for preparation and submission, submission language.
  - Timing: deadline for submission, offer validity and expected award times.
  - Details of pre-bid where applicable. (meetings/site visits, and/or samples/ demonstrations).
  - Provision of prototype samples of products were required.
  - Method of evaluation and evaluation criteria, including permitting third-party inspection companies where required.
  - Payment terms.
  - Contact information.
-

**In general, any Solicitation document, no matter the procedure, will contain:**

---

***The  
applicable  
Terms and  
Conditions***

- Ethical policies to be adhered by the supplier.
  - Special conditions applicable as; Termination; Trade Terms; Inspection; Warranties; Rights and Obligations; Remedies; Subcontracting; etc.
- 

The solicitation document must to be distributed simultaneously among the pre-selected suppliers with sufficient time to analyse and properly build offers. The solicitation document could contain a standard submission format facilitating the comparison among the offers during the evaluation phase.

## **Material Specifications**

When soliciting material goods, it's advisable to include as much technical information as possible about the material specifications, laid out in a clear and transparent format that is easy to understand but difficult to misinterpret. Material specifications might include:

- Unit measurements (weight, volume).
- Packaging measurements (weight, volume).
- Colouring/Visual appearance.
- Chemical composition.
- Conformity to specific ISO standards.
- Strength/durability.
- Packaging and handling specifications.
- Branding and marking specifications.

### **Following Specifications Throughout the Procurement Process**

These material specifications should be included in:

**Solicitations** - The more detailed the specifications, the more accurate the returned bids will be. Detailed specifications will help eliminate vendors that are unable to meet the specific requirements, but will also encourage vendors to only commit to what they know is possible.

**Contracts with suppliers** - Material specifications included in contracts will legally hold vendors to the standards set by their bids. The material specifications in contracts should match the specifications provided in the bid process.

**Instructions to third-party inspection companies** - Once a vendor is selected, and a contract agreed upon, third-party inspection companies can be used to test products against the contracted material specifications. Inspection companies may use visual inspection or laboratory testing to confirm all material specifications are met. Many agencies prefer to receive prototype samples of items prior to the final order, and conducting inspection at multiple points throughout the entire process. Purchasers may also chose to withhold payment until the final inspection is complete.

### **Specification Types**

Detailed specifications will vary depending on the item in question, the agency, the size of the procurement, and the market supplying the product.



<b>Item Type</b>	Some products with well established designs - such as machine parts - might require less spelled out specifications, and might rely more on specifying product capacity or functionality. Other products frequently used by the humanitarian sector - such as household products - are far more defined by specific needs, and are often combined with mutually recognised standards such as SPHERE. Though humanitarian agencies may have specific needs, the global understanding of those needs among vendors may not be well understood. For this reason, specifications for products specially developed or used for humanitarian interventions tend to be more explicit - usually the product is "developed" along side the vendor to match the purchasing agency's needs.
<b>Agency Needs</b>	Humanitarian agencies purchasing a small quantity of an item, or that buy already standardised products may have very little need to explicitly state product material specifications. However, agencies that purchase large quantities of one type of special product from a long term supplier or limited series of suppliers are more likely to have more advanced material specifications in their contracts. Detailed product specifications will help vendors source the correct raw materials, and will help keep quality assurance up.
<b>Markets</b>	Commonly used large international vendors are usually more likely to be able to meet detailed product specifications requested by humanitarian agencies. The manufacturing capabilities and raw materials available to local companies may not meet the overall requirements of the requesting agency for key relief items. The balance between international and local procurement is something agencies must weigh, depending on local laws, import and transport costs, the ethics surrounding procurement, the desire to support local markets, and overall project needs.

Many large agencies that regularly procure typical relief supplies have material specifications readily available, including the [ICRC/IFRC Catalog](#) and the [Oxfam Supply Center](#). These material specifications are useful as a reference point for any agency that wishes to enter into contracts for emergency relief supplies.

Example Material Specifications:

<b>BLANKET, SYNTHETIC, 1.5x2m, high thermal</b>	
Samples for testing purpose	Samples of blankets must be from compressed bales. All criteria to be passed on the same sample. (Samples of compressed bales to be prepared with only 5 blankets folded once more than in normal bales, at 60% compression ratio, and to remain compressed for one week minimum before testing).
Make	Knitted or woven, dry raised both sides. If any, inner layer can be non-woven type.
Content ISO 1833 on dry weight	100% pure polyester and/or acrylic fibres or polyester/cotton
Colours	Other than black, red, or white, dark uniform colour.
Size	150 x 200cm +3%/-1%. To be taken on flat stabilised sample, without folds.
Weight	500g/m <sup>2</sup> minimum maximum 1000g/m <sup>2</sup> weight determined by total weight/total surface.

<b>BLANKET, SYNTHETIC, 1.5x2m, high thermal</b>	
Thickness ISO 5084	9.5mm minimum (1KPa on 2000mm <sup>2</sup> )
Tensile strength ISO13934-1	250N warp and weft minimum
Tensile strength loss after washing ISO13934-1 and ISO 6330	Maximum 5% warp and weft after 3 consecutive machine washing at 30°C and one flat drying.
Shrinkage maxi. ISO 6330	Maximum 5% warp and weft after 3 consecutive machine washing at 30°C and one flat drying.
Weight loss after washing	Maximum 5% after 3 consecutive machine washing at 30°C and one flat drying.
Thermal resistance ISO 11092	Rct= 0.40m <sup>2</sup> .K/W minimum, rounded to the nearest 0.01, passed on samples picked from compressed bales. Mechanical conditioning: after opening of the bale, the blanket shall be dry tumbled in a dryer (500l minimum capacity) without any other load for 15 minutes at a temperature of less than 30°C. Then, the blanket shall be conditioned for at least 24 hours by flat lying at ambient conditions (20°C and 65% Relative Humidity).
Resistance to air flow ISO9237 under 100Pa pressure drop	Maximum 1000 L/m <sup>2</sup> /s
Finish	Whipped seam at 10mm from the edge with 10 to 13 stitches/10cm or stitched ribbon or hemmed on 4 sides. Corners can be round up to 10cm radius, or square.
Organoleptic test	No bad smell, not irritating to the skin, no dust. 4<pH<9. Free from harmful VOC (Volatile Organic Components). Fit for human use.
Fire resistance ISO12952-1	Resistance to cigarette - No ignition
Fire resistance ISO12952-2	Resistance to flame - No ignition
Primary packing	No individual packing of the blanket, in order to reduce plastic wastes in the environment.
Packing	<ul style="list-style-type: none"> <li>• Bales to be wrapped in a water-tight micro perforated plastic film and covered with a polypropylene or jute woven bag.</li> <li>• Quantity per bale: 15 pieces.</li> <li>• Compressed and strapped with 5 straps (2 lengthwise, 3 crosswise).</li> <li>• Bales dimensions: Length 85cm +/-5cm, Width 55cm +/-5cm, Height 75 cm +/-5 cm (height of the bales to be compressed by maximum 60% from free state to final compressed and strapped state)</li> </ul>

<b>BLANKET, SYNTHETIC, 1.5x2m, high thermal</b>	
Marking on the blanket	Every blanket should include a tag, stitched in the hem. The tag should include the manufacturer's name, a unique reference batch number and the date of manufacturing. No company logo should be included with the manufacturer's marking.
Marking on the package	BLANKET, SYNTHETIC, 1.5x2m, high thermal – 15 pieces. Other markings as specified in contract.

Source: [ICRC/IFRC Standard Products Catalogue](#)

## Evaluation and Awarding

Many agencies may choose to use what is known as a bid evaluation committee/panel to properly facilitate the process of analysing and scoring incoming offers in a fair and transparent way. After properly recording every step undertaken during solicitation process, and before bids are open, the evaluation committee/panel will join together to study the offers. An evaluation panel composition could be as simple as two people (requester and purchaser) performing an informal evaluation or be regulated formally and integrated by teams of different departments. No matter the value of the procurement or procedure followed, there should always be a set of people to respect the segregation of duties principle. In the case of the most restrictive procedures, it is common to form evaluation teams at the very beginning of the process, formalising the process by signing a "Declaration of Objectivity and Confidentiality" and /or a "Disclosure of Conflict of Interest".

The offers should be evaluated using the criteria and specifications of previously communicated PRs/bid solicitations, or any other part of the process prior to receiving bids. Common offer evaluation criteria might include:

- Competitive prices.
- Ability to meet specifications and standards.
- Product availability and ability to meet the requested delivery date.
- Product and service quality.
- Performance and durability of products.
- Reliable delivery methods.
- Quality control methods and practices.
- Technical and leadership skills.
- Ability to provide niche or unique products and / or to design concepts.
- Financial stability and credit.
- Payment conditions / requirements.
- Compatibility with existing products.
- Distribution / storage facilities and adequate resources.
- Availability of spare parts.
- Guarantee, insurance, and supply commitment.
- Proven ability and experience.
- Availability of service support resources.
- Previous experience and demonstrated performance in supplying the products / services to be purchased (to be verified in previous certificates of compliance. So, "bad past experiences" must be documented).

- Security.

All evaluation criteria should be:

- **Objective** - criteria that are verifiable and designed to measure facts rather than assumptions and promises from the supplier. Objective criteria are tangible, with little likelihood of being construed differently by different suppliers.
- **Unambiguous** - there should be no confusion or overlap in the criteria selection, description and evaluation.
- **Reliable** - clear and measurable criteria that can be evaluated consistently across multiple submissions and evaluators.
- **Fair** - criteria that does not unduly exclude suppliers from the procurement or give undue advantage to a specific supplier.
- **Balanced** - criteria with appropriate and defensible when viewed objectively in the context of the procurement action.

During the evaluation process, it is necessary to balance various tangible and intangible factors, some of which may conflict with each other. Methods for determining the extent to which a potential supplier can meet the criteria include:

- Visits to the supplier by the management and/or evaluation team (to visit the factory, warehouse, stock, production equipment and supplier equipment).
- Confirmation of the status of the quality system, either through an on-site assessment, a written report, or by requesting a quality system registration certificate as ISO certification or any other.
- Conversations with/recommendations from other NGOs served by the provider.
- Obtaining financial reports available to the public (available in some countries) and checking negative files.
- Evaluation (through laboratory tests or validation tests, for example) of samples obtained from the supplier. (see Quality Assurance)

To be able to present the evaluation results, is common practice to make a summary document, either in the form of a comparative table or a full report that has be signed by all the member of the evaluation panel. Any summary document must have a reasoned recommendation on the supplier selection and contain as many explanations as necessary about this selection.

Once the proposal to award a supplier has been validated, the selection of the suggested supplier should be validated by the requisite internal approval process of the agency. The award decision should be communicated to the winning supplier, and unsuccessful suppliers shall be notified establishing a mechanism able to debrief them and take note of any possible complaints.

## Ordering and Contracting

Each order has to be formalised through a contract, Purchase Order(PO), or other official award document.

- **POs** are a financial commitment that confirms the purchase details (Units, quantity, price, delivery time and Location, etc), formalising the order. The PO is used for simpler orders, one-off purchase and smaller amounts, where there is no need to define any complex situation, and/or where the purchase represent low risks for the organisation.
- **Contracts** are legally binding agreements between the organisation and the suppliers. They define the Terms and Conditions for the goods and services provided, as well as the

signatories related rights and obligations. Contracts are used when there is a need to specify the conditions in a complex order (partial deliveries, different timings or location, special conditions of the product, high financial volume or potential risk for the organisation, etc) and always for a work or a specialised service.

Hay una variedad de formatos y tipos de contratos utilizados para diferentes tipos de servicios y bienes, y diferentes plazos de entrega. Una lista de algunos de los tipos más comunes podría incluir:

<b>Cost-plus contract</b>	A buyer agrees to reimburse a seller for expenses it incurs when completing work. This contract type is common where expenses relating to the completed work can vary.
<b>Cost-reimbursement contract</b>	When the buyer and seller agree to a total amount, usually paid at the completion of a project or at another specified date. The seller typically provides an estimation of total costs, which is what is communicated to the buyer in the form of a budget. In the event the seller reaches the total cost before completion they may seek approval from the buyer to continue with the project or cease work. Additional costs, or materials or activities outside of budget would require a contract modification to continue. This type of contract might be necessary when cost flexibility is a requirement for a project, or if the scope of work is difficult to determine or if the project itself is at high risk. This type of contract is common for a sub-contracted service, such as a fully managed warehouse.
<b>Fixed-price contract</b>	An agreement between the buyer and seller to pay a specific amount of money for determined goods or services. The cost of the goods or services remains the same, regardless of how long it takes to complete or provide them. This type of contract is typical for securing air or sea shipments.
<b>Time and materials contract</b>	An agreement whereby a buyer agrees to pay a seller for the time the seller spends on the project and the expenses the seller incurs throughout the project. This type of contract is common for construction projects.
<b>Unit price contract</b>	An agreement between a seller and buyer to pay for a project by units of the job, such as specific duties or a specific product. If the seller is providing a service, the seller breaks the project up into units before beginning to work on it. Unit price contracts can establish a baseline for a product or service, but not define the number of units, or even necessarily the time frame over which the units will be purchased. This type of contract is common for buying stand-alone units of a specific product, such as a physical good or a single commonly obtained service.
<b>Aleatory contract</b>	An agreement between parties to perform a service or provide a product if a certain event occurs. The parties only have the obligation to fulfil the action if the pre-determined event happens. The type of contract is common for insurance policies.

Of the contract types, contracts can generally be broken down into two categories:

<b>Bilateral contract</b>	An agreement that binds two or more parties to mutual obligations. It can occur when a buyer and seller make an exchange of commitments to supply a product or perform a service. Both parties agree to the contract, and they make promises to perform a certain action.
---------------------------	---

---

<b>Unilateral contract</b>	When one party of the agreement makes a commitment to perform a certain action. The other party doesn't make a commitment to the agreement, so only the offerer has a contractual obligation.
----------------------------	---

---

Some agencies may prefer the use of some form of a Long-Term Agreement (LTA), where by a supplier is pre-vetted using a standard solicitation process, but has an open-ended contract for delivery of goods and services. Requesting agencies holding LTAs with vendors can use simple notifications for procurement needs, such as a PO, specifying units, quantities, delivery details, and other important information. The theory behind an LTA is that a single supplier used for routine procurement can be competed and vetted once in a pre-set period of time instead of having to bid every time.

The act of signing the PO - and the organisation's Terms and Conditions - by the supplier makes the PO become a simplified contract. An organisation should establish a threshold beyond which the relationship can no longer be formalised through a PO and a contract becomes necessary. Irrespective of the procurement method, each organisation's Terms and Conditions (TC) must be applied, and it is advisable to attach TCs to all contracts and POs.

## Reception and Payment

The order documents (PO or contract) must clearly indicate the delivery conditions. Delivery conditions detail who will assume responsibility for moving goods, when and where the responsibility for the products is transferred, and all the necessary details to plan transport and logistics.

*" Delivery planning involves the review and consideration of all logistics related aspects of the procurement process. It starts at the needs assessment phase by considering the desired result of the Requesting Unit and the end user and identifying the actions needed to ensure the successful completion of the activity. (WFP Goods and Services Procurement Manual, 2020)*

The transfer of responsibility between the seller/carrier and the agency is an important moment in the procurement process. The transfer of responsibility can be done at the manufacturer/seller premises, or be undertaken fully by the supplier who will be responsible transporting the cargo to the agreed destination. An agreed destination can be either an agency's premises, warehouse, or in special cases directly to the beneficiaries. The most standard used method of defining the method and location of the transfer of responsibilities is through [defining Incoterms](#) in the procurement contract. Incoterms are only applicable for international procurement however, so the transfer of responsibility in domestic procurement may need to be spelled out explicitly. In every case, the transfer of responsibility has to be clearly recorded through [the standard set of shipping documents](#).

For simpler deliveries, or when the supplier delivers to final destination, it is common to use a Delivery Note that must contain at least:

- The name and contact details of the seller.
- Name and contact details of the purchaser.
- Date of issue.
- Date of delivery of the goods.
- A description of the goods contained in the order.
- The quantity of each type of goods.

When goods are delivered, the recipient should perform a physical inspection of the packages against all delivery documents to ensure that they fully conform to the requirements of the contract, by checking:

- **The Quantity** - That the number received is the same as the one written in the documents and correspond to number requested in the PO.
- **The Quality** - That the product received is in the conditions mentioned in both the shipping documents and matches what was defined in the procurement contract, is not damaged and corresponds to the ordered specifications.

If any discrepancy is found in the quantity or quality, it should be recorded in writing on the delivery documents. Without written statement taken at the time of delivery it will be very difficult to claim later the products did not conform to the order.

The transfer of responsibility becomes effective when the representative of the organisation signs the Delivery Note. The signed Delivery Note, the PO and the Commercial Invoice will be the minimum mandatory documents to process payment. In the case that the supplier/carrier is not able to provide any delivery document nor even a Delivery Note, agencies may wish to create and sign a Goods Received Note (GRN), formalising the transfer of responsibility of cargo and stating any discrepancies. Agencies generating their own GRNs should still request the delivering supplier or the supplier's duly appointed transporter to countersign.

## Procurement Procedures

A procurement procedure is an internal process established by every organisation to ensure that the purchases made are compatible with the basic principles of responsibility, accountability, transparency, equal treatment of suppliers and proportionality, while guaranteeing the best value for money. Procurement procedures ensure objectivity during the supplier awarding process. The awarding criteria themselves will need to be adapted to the context, program needs and donor regulations.

A standard procurement procedure involves the following major steps:

- Suppliers' survey and /or publication (tender, Expression of Interest).
- Collection of technical/financial offers.
- Internal review of survey (offers analysis and comparison).
- Approval of the supplier selection.
- Review of the documentation and financial commitment authorisation.
- Publication/Communication of results.
- Order and/or contract's signature.
- Receipt/transport of the purchase.
- Payment to the supplier (based on previously agreed conditions).
- Final update, review of purchase dossier and its archiving.

Purchases are accompanied by significant cash flows, so agencies must take into account the impact they have on local markets, and the effect they may have on the beneficiaries.

## Most Common Procurement Procedures

“ For normal operations (not first phase of an emergency response), the procurement method is chosen based on a defined framework with value thresholds. The framework includes, as a minimum, levels for Direct Purchase, Competitive Quotations and Tendering. The levels of the thresholds are based on the context,

taking into account monetary values; frequency of transactions; lead time to process the procurement and organisation's risk tolerance. The threshold set is continuously respected throughout the normal operations and reflects donor and INGO requirements. ([PARCEL Project, Procurement](#))

Although each organisation and/or donor use different terminology, they all share the same logic and basic principles. For the purpose of this guide the names of different procedures will be as follows:

- Direct Purchase
- Competitive, Negotiated Procedure
- Tendering

## **Direct Purchase or Single Quotation Procedure**

The direct or single quotation procedure is the most relaxed one in terms of documentation, evaluation and requirements. Direct purchases are usually done for goods or services with a low total value. The main characteristic of direct purchasing is that the goods or services are acquired without prior comparison of prices or purchase conditions, which makes the process relatively quick and easy.

The unit or person responsible for procurement will buy from the most advantageous supplier identified in the supplier catalogue. If the ordered good or service is not listed in the supplier catalogue or is new, it is good practice to ask a supplier for an RFI that will help purchasers more accurately plan the procurement. The unit or person responsible for procurement should contact the supplier to confirm the price and assure the criteria of satisfactory quality, delivery times, competitive market prices and correspondence with the available budget.

A purchase dossier might contain:

- The fully signed Procurement Request that initiated the process.
- The Purchase Order signed by the relevant persons.
- Copy of the invoice.
- Proof of delivery of the items might include one of the following:
  - Supplier's Delivery Note.
  - Internal Reception Note when delivered without supplier delivery note.
  - Internal Delivery Note when delivered to the requester without supplier delivery note.
  - Original invoice, ideally with some form of formal approval written on it.



## Example PR

## Example PO

**Organization LOGO** **PROCUREMENT REQUISITION FORM**  
(for goods and services)

Agency/Project: \_\_\_\_\_ Requisition No: \_\_\_\_\_  
 Location: \_\_\_\_\_ Page Number: \_\_\_\_\_  
 Date PR Initiated: \_\_\_\_\_ Date Delivery Required: \_\_\_\_\_

If Specialized Items, suggest Supplier: \_\_\_\_\_  
\* Attach complete vendor detailed specification where applicable \* Use as many lines as needed to describe each item  
 \* Make separate requisition for different categories of goods or services \* Use multiple pages where required. Number each page.

No.	QTY	UNIT	Item Description	UNIT CURRENCY Line Allocation
1				
2				
3				
4				
5				
6				
7				
8				
9				
10				
11				
12				
13				
14				
15				

Additional Comments: \_\_\_\_\_

Requested by: \_\_\_\_\_ (name) /# \_\_\_\_\_

\_\_\_\_\_  
Program Officer or Department Head      Finance Officer      County Director, CoP or County Team Leader      Procurement Officer  
Please sign name and sign across above and enter date of signature below

\_\_\_\_\_  
Date approved      Date approved      Date approved      Date received

**Organization LOGO** **PURCHASE ORDER (PO)**

PO No: \_\_\_\_\_ PR No: \_\_\_\_\_ Date: \_\_\_\_\_

Vendor: \_\_\_\_\_  
 Address: \_\_\_\_\_  
 Tax No: \_\_\_\_\_  
 Contact Person: \_\_\_\_\_ Title: \_\_\_\_\_  
 Delivery Location: \_\_\_\_\_ Delivery Date: \_\_\_\_\_  
 Delivery Terms: \_\_\_\_\_  
 Special Instructions to Vendor: \_\_\_\_\_

SPECIFICATIONS:				Currency	Unit Price	Total
No.	QTY	Unit	Description of Goods and/or Services			
1						
2						
3						
4						
5						
6						
7						
8						
9						
10						
11						
12						
					TOTAL:	

Payment Terms: \_\_\_\_\_ by Bank Transfer / Cash / Cheque (tick applicable)  
 Requested by: \_\_\_\_\_ Position: \_\_\_\_\_

\_\_\_\_\_  
Program Officer or Head of Department      Finance Officer      County Director, CoP or County Team Leader      Procurement Officer  
Date      Date      Date      Date

Please sign name, sign across and date above and sign on other pages that are integral part of this Purchase Order  
 Vendor agrees to deliver/perform all goods/services set forth above and on any scope of work attached hereto for the job specified in accordance with the Terms and Conditions set forth herein.

Signature: \_\_\_\_\_ Name: \_\_\_\_\_ Title: \_\_\_\_\_  
 Vendor's authorized representative

## Competitive, Negotiated Procedure

Comparative bidding is the process of soliciting cost/project proposals for products, services or works from "bidders". The selection criteria must be established and communicated in advance to potential bidders. For procurements of higher amounts, more information is usually required to objectively evaluate and justify cost effectiveness. A documented comparison of prices and purchase conditions should be carried out prior to the purchase itself.

Once the terms of the purchase request have been agreed, an official and detailed RFQ must be prepared in writing, which will be sent to multiple suppliers (most organisations use at least three different suppliers), or the sufficient number of candidates to ensure genuine competition. The RFQ should ideally set a date for the offer's delivery, list the technical specifications, and detail the selection criteria that will apply to the process. In the event that the minimum number of quotes cannot be obtained, as a good practice the purchaser should attach copies of the quote requests sent to the different suppliers as evidence all efforts were taken properly. All quotations must be complete and must clearly indicate the name and address of the suppliers, as well as the offer validity.

Some agencies make exceptions in cases where a quotation from a supplier is exactly the same

as a previous purchase and the supplier quotations are still valid.

**Mission SYRIA**

<b>To:</b>	BASE LOGISTICIAN	<b>Date:</b>	
<b>From:</b>	Purchase Dossier Ref:		
<b>For:</b>	Supplying submersible pumps, control panels, electric cable for HA, DOW drinking water wells تقديم مزيجوات طرح غاطسة مع لوحات التحكم والكابل الكهربائي لأبار مياه الشرب لعمال حوض مياه البياض بدمشق		

**OBJECT:** Project of supplying submersible pumps, control panels, electric cable for HA, DOW drinking water wells  
تقديم مزيجوات طرح غاطسة مع لوحات التحكم والكابل الكهربائي لأبار مياه الشرب لعمال حوض مياه البياض بدمشق

Item description	Quantity	Unit	Remarks
Supplying submersible pumps تقديم مزيجوات طرح غاطسة	8	ع Each	According to Attached Tech.Specs ر
Supplying Elc. Control panels ت	8	ع Each	According to Attached Tech.Specs وفقاً لاختصاصات الشروط والامسندات المرفقة
Supply electricity cable (3*25) mm2 from the good quality in local markets الكهربائي بدمشق (3*25) مم2 من المزيجوات الجيدة في	900	م.ل M.L	According to Attached Tech.Specs and sample of 10 cm length should be submit with technical offer لواصفات العرفق على ان يتم تقديم عينة اسطول
Supply electricity cable (3*16) mm2 from the good quality in local markets الكهربائي بدمشق (3*16) مم2 من المزيجوات الجيدة في	755	م.ل M.L	According to Attached Tech.Specs and sample of 10 cm length should be submit with technical offer لواصفات العرفق على ان يتم تقديم عينة اسطول

\* Duration of works: 15 DAYS  
مدة الاعمال: عشرة ايام

**Selection criteria:**  
البيانات التي يجب ان تتضمنها  
Competitive price: اقل سعر  
Quality of the service: جودة الخدمة  
Offer Validity (1 MONTH preferably): مدة العرض (شهر واحد)  
Proven experience and I ability/Work certificate with other INGO's, UN agencies: الخبرة والجدارة والقدرة على العمل بطريقة تلقائية مع المنظمات الغير حكومية او المنظمات ايام المتحدة  
Payment conditions: شروط الدفع  
Adequate and qualified human resources: موارد بشرية كافية ومناسبة  
**Terms and conditions:**  
الاطراف غير المتعاقبة  
Payment by bank transfer: الدفع عبر التحويل المصرفي  
Company remain the sole responsible for its workers and guarantees the respect of security and safety rules!  
يجب ان تتحمل العروض خلال 5 ايام من استلام الطلب  
Establishing a mid-long-term relationship: اقامة علاقة بنوع ما او طويلة المدى  
Establishing this Contract doesn't abrogate ACF to purchase right away after the signature of the agreement  
انشاء هذا العقد لا يلزم بطلان العقد مع اية منظمة غير حكومية او منظمة ايام المتحدة  
we will reject any offer that contains turkish Brand  
نرفض اي عرض يحتوي على اية منتجات تركية  
**Offers must be submitted in the format attached and must include:**  
1- Name, address, phone and contact person: اسم الشركة او الشخص المتعاقد  
2- Validity of the offer (minimum 1 MONTH from the date of the offer): صلاحية العرض (شهر واحد)  
3- Unit and total price, including the cost for adequate human resources: الوحدة والاسعار الكلية بما فيها تكاليف الموارد البشرية  
4- Payment conditions: شروط الدفع  
5- Estimated total duration of the works: المدة المقدرة للتوقيع للخدمة  
6- Copy of the company license and registration number: نسخة عن رخصة الشركة ورقم التسجيل  
7- Date, stamp and signature: التاريخ والختم والتوقيع  
**Offers submitted after the deadline will not be considered.**  
كافة العروض التي يتقدم بها بعد مدة انتهاء العرض سوف لن تُقبل  
For any complaint please send an e-mail to this link: [wb@sy.sya.afspain.org](mailto:wb@sy.sya.afspain.org)  
لتقديم اي شكوى يرجى ارسال رسالة الكترونية الى هذا الرابط  
Note: This quotation request is not an order and does not commit ACF in any way.  
تقديم عرض  
To submit an offer  
الرد المطلوب قبل تاريخ 2/12/2016  
العرض المرسله تحت الغلاف الى:  
تاريخ الاستلام  
توقيع و الختم  
Received On:  
Stamp And Signature

1

2

3

4

5

6

7

1. Dossier of Information
2. Product, Service Information
3. Selection Criteria
4. Terms and Conditions
5. Expected Offer Composition
6. Feedback Mechanism
7. Deadlines and Signatures

Example: A quotation for Submersible pumps in ACF-Syria 2016.

Quotations are analysed based on the selection criteria mentioned in the RFQ and the results will be presented in a bid matrix. The supplier selection is generally the joint responsibility of person or team managing procurement and the person or team making the request for procurement.

Before the financial commitment becomes effective, some agencies choose to add an additional layer of validation, whereby the heads of the procurement and financial departments approve the purchase, certifying that both the process followed and the financial allocation are correct. In the case of contracts with a high amount, the validation of the pre-identified relevant persons is usually mandatory.

A purchase dossier ideally should contain:

- The fully signed Procurement Request that initiated the process.
- The originals of the different suppliers' quotations received and the request for those quotations (especially if no quotes were received).
- The negotiated procedure evaluation table with all necessary validations, along with an explanatory note, if relevant.
- The PO or Contract signed by the parties.
- Copy of the invoice, ideally referencing the solicitation number or other tracking number.
- Proof of delivery of the products:
  - o Supplier's Delivery Note.
  - o Reception Note when delivered without a supplier delivery note.
  - o Internal Delivery Note when delivered to the requester without a supplier delivery

note.

## Public/Open Tenders

Unlike the negotiated procedure where an organization recognises at least three (3) potential suppliers from whom it requests a quote, a public or open tender is the process of opening bids to the public and inviting anyone to submit an offer. Offers are evaluated by a tender evaluation committee created at the beginning of the process. It is strongly advisable that all members of the evaluation committee and the employees involved in the bidding process are obliged to understand and sign some sort of declaration of objectivity and confidentiality or a similar document.

All documents necessary for the tender must be prepared and have been verified before the start of the tender. These documents are generally sent to headquarters for approval prior to the publication of the tender. An open national tender might consist of:

- Creation of the evaluation committee.
- Definition of the supplier selection criteria.
- Tender Notice publication in the media.
- Sending the Tender Dossier/RFP to interested suppliers who have requested it.
- Complete the List of applicants and bidders.
- Evaluation of all bids received using some sort of evaluation report.
- Awarding a contract to the chosen provider and inform those not chosen.
- Signed contract.

A Purchase Dossier might include:

- Declarations of objectivity and confidentiality.
- Any waiver (ex. nationality and provenance of the goods).
- Copy of the newspaper/ website carrying the Call for Tender.
- Participation requests.
- Tender dossier.
- Opening session minutes.
- Offers received.
- Tender evaluation report with comparative table.
- Tender report.
- The HQ's authorisation of the award.
- Signed contract and any subsequent addenda.
- Report of acceptance of goods or completion of services and/or works.
- Commercial invoice.
- Delivery notes.
- Payment.
- Payment receipt.

The tenders could have a different geographical scope, allowing only local economic operators to see and submit and offer, or allow anyone nationally or internationally to present their offer. Things to consider when selecting geographical restrictions include local economies, the efficiency in the process, ethical standards and environmental care while assuring the availability of the product/service in the terms that are needed by the organisation.

It is also possible to make tenders:

- **Open** - where all interested suppliers may submit a tender
- **Restricted** - only suppliers within a pre-defined scope or category may take part.

## Setting Thresholds

The concept of "thresholds" is key to determining appropriate procedures to apply. Thresholds ensure the principle of proportionality between the purchase market cost and the level of effort required to obtaining the best purchase conditions.

Thresholds work by defining a dollar value at which higher levels of signature or approvals are required. The higher the value of the procurement, the higher the approval authority and the more detailed the procedure to be applied.

As an example, an agency may wish to set a threshold at \$500 USD:

- Below \$500 USD, only a local logistic officer and requester are required to sign off, and only a PO is require.
- Above \$500 USD, the head of base/mission and/or the head of finance may be required, and a competitive bid may be required.

The nature and limit of each threshold will be determined by individual agencies, based on their own financial oversight needs and guided by:

- Donor regulations
- Country/national level requirements
- Internal organisational audit procedures

The level of thresholds and the required procedures should be included in each agencies' procurement manual or procurement policies.

## Comparative Table Different Procedures

Following the proportionality principle, it is advised to increase the complexity of bidding and evaluation if the total amount is higher that the value of the proposed procurement.

	<b>Direct Purchase or Single Quotation</b>	<b>Competitive, Negotiated Procedure</b>	<b>Tender Value</b>
<b>Threshold:</b>	Low value	Medium	High
<b>Level of publicity:</b>	None	Medium (min. 3 suppliers contacted)	High (publication in media, public opening of offers, public award notice)
<b>Evaluation:</b>	Light, one person	Medium (Logistician + Requester)	High (Tender Evaluation Committee, min. 3 people)
<b>Documents:</b>	Few (PR, PO, Invoice)	Medium (PR, RFQ, Quotes, Bid Analysis Table, PO, Invoice, GRN)	High (13 templates)

	<b>Direct Purchase or Single Quotation</b>	<b>Competitive, Negotiated Procedure</b>	<b>Tender Value</b>
<b>Validation:</b>	Field level	Country Level + HQ (in some cases)	Country + HQ for Tender Dossier and supplier selection

## Bid Splitting

"Bid splitting" is the act of artificially splitting a bid among several smaller purchases instead of a single large purchase. Artificially splitting a bid within a budget is usually done to avoid a relevant procedure, and is considered a bad practice and may constitute fraud.

Bid splitting becomes fraudulent when the objective of the persons managing procurement is to apply a less restrictive procurement procedure than what best practice or agency wide procurement procedures might advise. Splitting a bid may not always be fraudulent when circumstances necessitate it for security, cost-effectiveness, and other justifiable reasons. Any decision to split a bid must be clearly explained and documented.

## Donors and Grant Funds

Donors are entities, institutions or individuals that finance the projects that an organisation implements. Procurement procedures must guarantee that all goods, services and works are obtained in accordance with their procurement policies, as well as all the laws applicable to these expenses.

Any person or team responsible for procurement must be familiar with donor procurement-related regulations at all stages of the project cycle and ensure that a organisation fulfils its contractual obligations to the donor. Among other actions, the procurement unit must verify if the donor has specific rules on thresholds and procurement procedures, as well any specific regulation applicable to the acquisition of medical or agricultural products, equipment, etc.

1. General regulations donors:
  - Donor thresholds.
  - Nationality and/or origin requirements of products.
  - If donor approval is required (evaluations, audits, etc.).
  - Specific regulations for specific products (medicines, medical supplies).
  - Sanctions or anti-terrorism controls
  - Denied entities to procure from.
  - Possibility of using HPCs (Humanitarian Procurement Centres).
2. Specific regulations pertaining to any agreement signed with the donor.
3. Expense eligibility or contract start and end dates – allowing time enough for the procedure to take place and the goods/service to be delivered.

Title

Download - Purchase Order Template

File



**Market Analysis**

## Market Analysis

“ Market analysis is a key component of response analysis; it informs the design and implementation of appropriate interventions using and supporting local markets” (The Cash Learning Partnership, Minimum Standards for Market Analysis (MISMA))

In a crisis context the humanitarian sector has an enormous capacity to impact the local market. It is important to act based on humanitarian principles and values and keep in mind the concept of “Do not Harm”. Market analysis is an essential component of context analysis, collecting information that will be useful to program the intervention and how to implement it. It is also a critical element of contingency planning and preparedness.

Key factors in a market analysis:

- Nature and origin of the products offered.
- Local manufacturing capabilities.
- Main local products.
- Storage capacities of suppliers.
- Transportation routes and potential risks to stock.
- Knowledge of the relationships between the different agents.
- External, political, meteorological factors.

Source: [IFRC](#)

## Tools

There are several key tools from where the information about the market can be extracted. As an agency or individual conducts procurement, there is a large volume of information that will help to analyse the market that surrounds the organisation. Humanitarian agencies should to conduct revised market assessments as needed.

- **List of suppliers** - Many persons may be involved with procurement in a single agency. It is highly suggested to keep a catalogue of suppliers where basic information about the products they offer can be found, as well as past experiences or any other relevant information.
- **Request for Information (RFI) and Expression of Interest (EOI)**- RFI and EOI are Documents through which information will be requested from suppliers to make their offers official, but also through which can be carry out the market analysis of a specific product.
- **Purchase tracking** - Any system used to track the current status of procurement, and inform other departments about the status of their requests and in general.
- **Price list** - Track historical procurement costs, inform planning assumptions, and track the evolution of the costs of goods and services on the market.

## Supplier Analysis

Sometimes it is difficult to get an idea of a supplier only through official bid documents. Purchases may want to visit the suppliers in their workplace, especially when agencies intend to start a lasting relationship with a given supplier. Do not underestimate the power of an in-person conversation, or the details that can be learned by knowing their facilities.



Helpful steps to follow:

- Establish a first contact with the supplier.
- Analyse supplier capacity and professionalism: number of workers, work methods, general cleaning, etc.
- Analyse the products or services available. Where does the supplier buy the product or raw material? How are products delivered? Can they import better/cheaper products?
- Understand the supplier's business model, its challenges, its sources, its problems.
- Gather information that would never otherwise be reflected on paper.
- Identify other possible selection criteria in addition to price.

### **Supplier Ineligibility**

It is strongly advised to excluded suppliers from any procurement for any of the following reasons:

- They are bankrupt or are ceasing activities.
- They have been found guilty of serious professional errors.
- They are found to engage in child labour, sexual exploitation and abuse, slavery, bribery, gross environmental negligence, or undue worker safety.
- They have not fulfilled obligations related to payment of taxes as per legislation of the

country or in the country benefiting from the contract.

- They have been tried and finally convicted for fraud, corruption, participation in criminal organisations or any other illegal activity.
- They have been declared seriously in default for failing to observe contractual obligations in other purchase procedures made with the organisation.

As evidence proving that potential supplier does not come under one of the above-mentioned situations, the candidate supplier shall submit at least one of the following documents:

- A recent extract of judicial records.
- An equivalent document issued by a judicial authority.
- An affidavit testifying that the supplier respects basic social rights and working conditions and does not exploit child labour.
- Affidavit sworn by the company's legal representative before an administrative or legal officer, an auditor or a qualified body in the country of origin or provenance.
- Self-certification on the above-mentioned judicial status.

Background checks are strongly advised prior to contracting with an agency:

- Where possible, agencies should conduct background checks on vendors and suppliers using the available local means.
- Some donor agencies require screening of vendors against additional international lists pertaining to criminal activity or terrorism.
- Aid agencies should always ask for references from other known sources who may have procured goods or services from the identified supplier in the past.

Contracts should not be awarded to bidders who during the procurement procedures:

- Are subject to a conflict of interests.
- Have omitted to supply the information requested by the organisation as a condition of participation in the procurement procedures or they have supplied untruthful information.
- Are guilty of corrupt practices, fraud, collusion or coercion.

## **Supplier Management**

Supplier management is a set of principles, processes, and tools that can help organisations maximise supplier relationships, minimise risks, and manage overheads throughout the entire relationship life-cycle. Active supplier management entails creating closer and more collaborative relationships with key suppliers to achieve greater value and reduce risks.



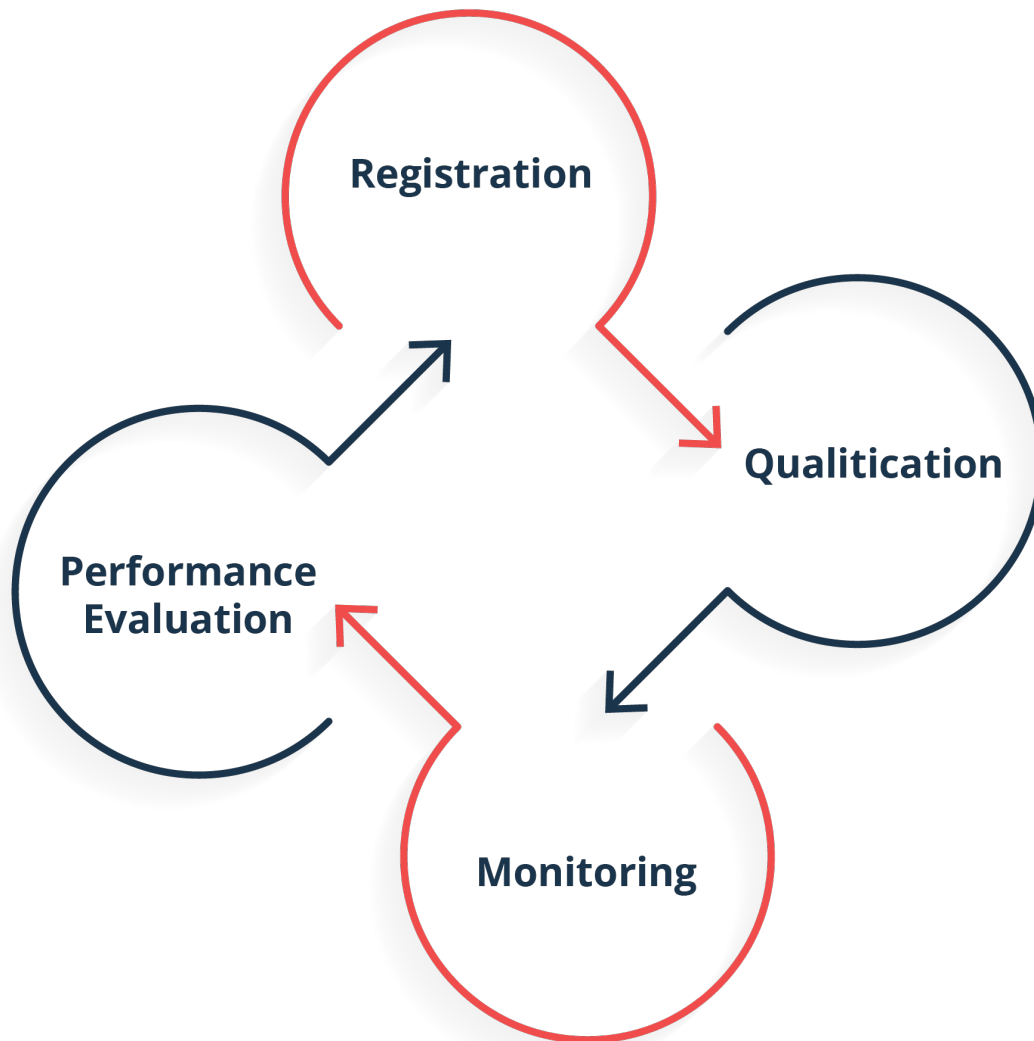

It is important to know specifications of the products or services required, the legal framework for their acquisition and their availability in the market. Not taking these three concepts into account increases the risk of not finding required items, procuring incorrect items, or not respecting local norms and behaviours when purchasing them.

The objectives of an effective supplier relationship management are to:

- Foster long-term relationships and joint value creation.
- Prioritise resources and interaction with suppliers that can provide the greatest value for money.
- Ensure measurement of quality and service levels.
- Develop a consistent mode of interaction with suppliers across the organisation.
- Ensure fairness, integrity and transparency.

## Process

### Supplier Registration

It is strongly advised to register suppliers who meet key criteria, including assuring that:

- They have legal personality and legal capacity to enter into a contract.
- They shall have sufficient financial capacity (where required, the last two years audited accounts) to successfully undertake a contract awarded by the organisation.
- The products or services offered must be of interest to the organisation and the supplier must have the necessary professional and technical competence.
- The supplier must not be on any sanctions list and has not performed fraudulent, unethical or illicit acts.
- The supplier shall have the adequate experience.

For certain categories of goods and services, or in certain country specific contexts, suppliers may be required to meet additional/different criteria in order to be registered.

## Supplier Catalogue

A supplier catalogue is a tool where every supplier is registered and all the information about their relationship with the purchaser is stored.

<b>Supplier Pre- Qualification</b>	Pre-Qualification is generally used to pre-select suppliers for the provision of complex/strategic goods and services based on very specific needs. This selection can be from a supplier catalogue or include other providers. Only invited suppliers that meet established criteria should be invited to bid, ensuring that only companies with a high level of quality and/or expertise are included in the solicitation.
<b>Supplier Monitoring</b>	Monitoring of supplier activities in most cases is done through the standard set of <a href="#">procurement documents</a> . Each procurement step has to be explained and justified and all the official communication has to be documented. It is a best practice to create and update a tool to record key indicators in the procurement process. Such a tool might record all the interactions with the suppliers, allowing the agency to analyse and monitor the relations through time. Key indicators might include, but are not limited to response rates, records of evaluated proposals, number of contracts awarded, POs managed, and expenditures.
<b>Supplier Performance Evaluation</b>	Measurement of the performance of suppliers in support of an organisation's needs is important. Historical supplier evaluation influences the identification of suppliers who may be short-listed in the future.  Surveys are an important source of information. The requesting unit should be asked about their opinion about supplier performance in a standardised and official manner. Responses should be included in the supplier catalogue, to be referenced when new procurement actions are being planned.

## Supplier Management Tools

Once supplier(s) are identified, it is useful to:

- Define the exact needs and what you want to negotiate.
- Understand exactly the supplier offer/bid.
- Know your supplier and the market.
- Manage the timelines for delivery of goods and services.

The objective of any negotiation is to achieve a "win to win" situation. If one party in a negotiation does not feel benefited in some way, the relationship tends to break down.

When entering negotiation, it is important to have at least two real possible outcomes to choose from; this will make the negotiation more efficient by having a margin of safety and not feeling/establishing a dependency relationship.

An agreement between the two entities must be formalised, the obligations of each party clearly established, and a mutual understanding of what should be expected from the relationship well understood. There should be well understood steps to take in case of non-compliance to help avoid conflict. The best way to improve working practices in a supply chain is to work hand-in-hand with suppliers to help them to implement achievable improvements.

There are two main tools to manage the relation with a supplier:

- Contract
- Long-Term Agreement (also called Framework Agreement)

## **Contracts**

A contract is an agreement with specific conditions between two or more people or entities in which there is a commitment to do something in exchange for funds. The existence of a contract generally requires the following elements:

1. An offer.
2. The acceptance of that offer.
3. A commitment to carry out.
4. A consideration (which may be a promise to pay in some form).
5. The moment or the situation in which this commitment has to be carried out.
6. The terms and conditions of execution, including the fulfilment of the commitment.

Everything that is worth mentioning must be included in the contract, including the technical quality of the product or service, through the form and conditions of payment, to details about compliance. What is not included in a contract cannot be enforced. It is advisable to dedicate enough time to develop a good contract with mutual agreement with a supplier.

It is advisable to build a contract template, with as fixed a structure as possible, and with simple and direct language. It is common to review the signed contracts to resolve doubts and knowing the structure of our contracts helps to save time. A good practice is to have any contract template reviewed by a local lawyer, who can ensure any contract term is in accordance with the law, and who could advise on local customs and practices.

In the event of any contract dispute, the agency must communicate with the supplier in question. If necessary, a friendly discussion is always preferable. Most conflicts with a provider are resolved with dialogue and the commitment to resolve small details, but this discussion should be formal, including a lawyer if necessary.

Going to court should be avoided whenever possible. Having good contracts that anticipate how possible breaches will be resolved is key. The use of financial penalties is useful during negotiation and a tool in case of conflict.

## **Long Term Agreements (LTAs)**

A Long Term Agreement, known as well as Framework Agreements, establish the commercial terms and conditions that will govern between the supplier and the procuring agency in the event that there is a firm order for the goods or services established in the agreement. An LTA aims to define the commercial conditions that will apply to the purchase of specifically determined goods and for a pre-established period of time. LTAs are especially relevant for

small, low-value and less complex items purchased on a regular basis, such as office supplies, most spare parts, cement, prepaid mobile phone service, etc.

An LTA is applicable when several deliveries are expected, but neither specific quantities nor delivery dates can be foreseen. It is important to understand that a LTA is not in itself considered a purchase commitment, but simply sets out the conditions that would apply if the organisation decided to place an order. There is no commitment or exclusivity!

To avoid confusion and possible conflicts, it is essential to make it very clear to suppliers from the beginning of the bidding process that the objective is to sign a LTA and not a regular purchase contract. It is important to ensure that bidders understand the difference between these mechanisms. Since there is no exclusivity, an LTA can be signed with two or three different suppliers of the same products, under identical terms.

There are certain advantages inherent in the LTA that make it useful in any agency purchasing strategy, such as avoiding the repetition of processes and the corresponding paperwork for the same item throughout a project. Being by definition a larger purchase, organisations can get the best product/service at the best price in the shortest amount of time.

As a lasting relationship is established with the supplier, it is possible for agencies to work on the quality of the products/services that they offer to organisations, since agencies will be able to develop the relationship with suppliers to better understand needs and ways of working. In addition, sometimes LTAs are the only way to follow the correct procedures when only a short time is available. Organisations can follow all the procurement process without any requisition, being in a position to respond to requests in less time.

## Quality Assurance

Quality assurance (QA) is a procedure to ensure the quality of products or services by preventing mistakes and defects in manufactured products and avoiding problems when delivering products or services to beneficiaries. It is based in two principles:

- **Fit for purpose** - The product should be suitable for the intended purpose.
- **Right first time** - Mistakes should be eliminated before they happen.

QA focuses on improving a process and making it efficient and effective as per pre-defined quality standards. QA plays a role in the ability of an organisation to self-assess and ensure that internal processes are efficient and effective. It also ensures the existence of mechanisms and tools to ensure suppliers and products meet agencies needs.

For internal and external evaluation, the QA complete process has a defined cycle called P.D.C.A. The phases of this cycle are:

- **Plan** - Organisation should plan and determine the processes that are required to deliver a high-quality end product.
- **Do** - Development and testing of processes and also "do" changes in the processes.
- **Check** - Monitoring of processes, modify the processes, and check whether it meets the predetermined objectives.
- **Act** - Implement actions that are necessary to achieve improvements in the processes.

Sometimes organisations do not have the capacity to assess in these terms for each supplier, however there are audit companies and standard certification organisations that can. Agencies should seek these third-party agencies out and/or include those certifications as criteria for vendor selection.

## Standard Certifications

There is a wide range of quality certifications, from seals applicable to an entire sector or to a specific product to, those that certify the quality of a process or those that focus on compliance with ethical and environmental standards. Some have great added value, others have more to do with marketing. They can have a national value or be internationally recognised. Although each stamp can be useful, International Organisation for Standardisation (ISO) standards are the considered the recognised international best practice.

ISO is an independent, non-governmental Organisation created in 1946, and has been developing standards relating to manufacturing, managing processes, delivering services or supplying materials.

Some of the most useful in the humanitarian sector are the following “families” standards:

- **Quality management** standards to help work more efficiently and reduce product failures. (ISO 9000 Family)
- **Environmental management** standards to help reduce environmental impacts, reduce waste and be more sustainable. (ISO 14000 Family)
- **Health and safety** standards to help reduce accidents in the workplace. (ISO 45001 Family)
- **Energy management** standards to help cut energy consumption. (ISO 50001 Family)
- **Food safety** standards to help prevent food from being contaminated. (ISO 22000 Family)
- **IT security** standards to help keep sensitive information secure. (ISO 27001 Family)

Buying a product with an ISO certification and/or to a company that has been ISO certified is a guarantee that the product or company has followed a quality process. Not all suppliers have ISO or other kind of certifications, especially in low income, disaster or conflict settings. Without these standards in place, agencies may need to look for other sources of information to assure the quality before or during establishing a relation with a supplier.

## Vendor Social/Financial Audit

A social/financial compliance audit, also known as an ethical audit, is an inspection of an external organisation that verifies whether the supplier operations complies with social and ethical responsibilities, health and safety regulations, and labour laws. These audits help to judge if a supplier meets the organisation code of conduct, assuring the ethical policies.

A Financial audit can be complemented with the country fiscal year declaration and/or with bank statements that will help to evaluate their solvency.

Due to the "snapshot" nature of audits, and the fact that they are not designed to identify the causes or solutions of problems, they are limited in what they can tell about the suppliers' working practice. For that reason, getting maximum benefit from audits involves being aware of these limitations, and adding the right questions to complement them.

## Inspection and Quality Control

Agencies should schedule time and resources to perform inspection during the product evaluation, before the order, or during reception. Quality Control (QC) is a continuous, standard and permanent process until the distribution/delivery to the beneficiaries, therefore must to be performed periodically while a product is the warehouse or under the organisation responsibility. Sometimes, QC is confused with the QA. Quality control is used to examine the product or service itself. Quality assurance is to examine the processes and make changes to

the processes which led to the end-product.

- **Visual Inspection** – If a vendor supplies prototype sample prior to final delivery, organisations or specialists may wish to visually inspect and test the product, either at the vendor premise or at another off-site location.
- **Laboratory Testing** – In addition to visual inspection, agencies may wish to employ third-party laboratory testing. Lab testing may include testing for chemical composition (for durable construction materials or for pharmaceuticals), may test against pre-defined ISO standards (such as flame retardancy of NFIs) or even the quality of food stuffs.
- **Third-Party Inspection** – Many agencies wish to employ third-party inspection companies to carry out quality assurance. Third-party inspection companies will generally conduct lab and visual product testing, but may also visit suppliers' warehouses and production facilities throughout the production process to ensure full compliance. Organisations that utilize third-party inspection services may want to include the obligation of suppliers to allow third-party inspection companies into production sites without advanced notice to enhance the randomness of the process.
- **Provision of Certification** – Simpler than conducting independent laboratory testing, suppliers may be asked to produce certificates indicating conformity or quality. Typically, this pushes the cost and complexity of laboratory testing onto the vendor, but may also lead to forgery or fraud as the inspection process is out of the hands of the procuring agency.

It is strongly advised that product inspection must also be conducted once the procuring agency takes possession. Not only should products be inspected the first time they are delivered, they should be reviewed throughout the delivery process. For large orders that may have multiple or ongoing deliveries, product substitution can be and is a real problem. Some vendors may unscrupulously swap legitimate products for false, inappropriate or incorrect products later down the line. Without ongoing vigilance, even fully tested and certified products may not actually show up.

## Fraud Prevention

Corporate fraud in any organisation runs ethical risks and leads to waste. In the case of non-profit institutions dedicated to tasks such as development or humanitarian aid, it threatens basic elements of their programming and their credibility within the community. Consequently, fraud must be dealt with swiftly and thoughtfully, anticipating events and not only reacting once they have been perpetrated.

Various forms of fraud can be referred to as:

- **Fraud** is defined as any intentional act or omission, designed to harm others, with the result that the victim suffers loss or damage and / or the perpetrator makes a profit.
- **Corruption** is the misuse of a power entrusted by delegation, for private purposes, such as personal enrichment or that of a third-party, a friend, a family member. It consists of refraining from doing, facilitating something, or taking advantage of its function in exchange for a promise, a gift, a sum of money, or advantages of various kinds.
- **Misappropriation** consists of the theft or misuse by any means of a resource or material owned by a third-party.

We can place these three at the same level - they are all improper conduct. This guide will refer to fraud and anti-fraud policies when referring to all three of the aforementioned categories. To deal with fraud, it is necessary for organisations establish an anti-fraud policy document. Likewise, the entity must periodically assess the exposure to the risk of fraud.

The anti-fraud policy must contemplate three elements:

**Prevention** Imparting the organisation's values by its workers by explaining the possible consequences of fraud for the organisation. Organisations should also seek to establish a code of ethics and conduct, which must be communicated and disseminated throughout the organisation, including the appropriate communication channels and complaint formats. Staff should be trained in the identification, categorisation and use of these channels and formats. Establish alert mechanisms that can anticipate and prevent the commission of fraud.

---

**Control** Creating an anti-fraud commission whose responsibility is the investigation and verification of compliance with the policies of the institution, dedicated to the systematic or ad-hoc examination of the practices observed by persons or bodies of the institution. This commission will be in charge of establishing a compliance program with the established policies and norms and their monitoring. To obtain good information staff must feel safe when reporting, but at the same time they must feel the responsibility to provide truthful information. Clear responsibilities must be established and due protection to the complainant and protection against false reports.

---

**Reaction** Displaying the principle of zero tolerance through quick and determined actions, reaction to fraud must always be undertaken using strong evidence. This is only achieved with the collaboration of whistle-blowers and in-depth investigations and the prior establishment of appropriate and consistent measures. Except where security may prohibit it, reaction policies and processes should be made public, and communicated among the staff, donors and beneficiaries. Communication of policies are usually sensitive and should be planned in advance.

---

It is important to be aware that fraud prevention regulations cannot by themselves guarantee the non-existence of fraud. The effectiveness of fraud prevention guidelines relies on the organisation and the individuals that comprise it.

Procurement fraud may include, but is not limited to:

- **Collusion between providers** - A group of suppliers work together to manipulate their bids in order to rotate winners.
- **Division of the offer** - Demand is split into multiple bids to pass through a lower threshold and therefore reduced due diligence supervision.
- **Adaptation of the offer** - Persons within the agency deliberately draft bid documentation to tailor it to the specific strengths of a specific supplier.
- **Price manipulation** - A supplier charges a price higher than the one agreed in the contract / framework agreement.
- **Product substitution** - The organisation obtains and pays for a certain specification, but the supplier provides a lower / different specification.

Key red flags to watch out for may include, but are not limited to:

***Related to Suppliers:***

- Undisclosed conflict of interest.
- Winning suppliers outsource to losing bidders.
- The last provider to submit a bid wins the contract.
- Offers that look similar on paper, font, colour, spelling errors, printing, etc.

- Inflated invoices or purchase orders.
- The winning bid is higher than the rate from the market.
- The winning bid is identical to the budget.
- Fictitious suppliers or suppliers without existence or physical address.
- Turnover pattern of winners.
- Partial delivery of goods or services.
- Quality of the delivered items differs from the supplied/proposed samples at the bidding stage.
- Qualified contractors do not submit bids.

***Related to Personnel:***

- Manipulation of the evaluation criteria after the opening of the tender.
- Contracts awarded by single source or non-competitive process.
- Requirements defined in a way that only a specific manufacturer or supplier can meet.
- Multiple purchase requests started in close proximity for similar requirements to avoid boundaries threshold.
- A staff member does not separate duties.
- Excessively narrow or wide specifications.
- Officials do not delegate their responsibilities or they refuse to go on vacation.
- There is no clear information on the presentation of offers.
- Inadequate documentation (no PR, PO, bid analysis and GRN).
- Overly friendly relationship between a provider and any persons conducting procurement.
- Unusually high exemption rate.
- Tender announcements scheduled to match with holidays.

## **Procurement Tools and Resources**

### **Templates and Tools**

[TEMPLATE - Bid Matrix](#)

[TEMPLATE - Purchase Order](#)

[TEMPLATE - Purchase Request](#)

[TEMPLATE - Supplier List](#)

[TEMPLATE - Tender Report](#)

### **Sites and Resources**

- [Sphere Project, Handbook \(2018\)](#)
- International Review of the Red Cross (2016). *Principles guiding humanitarian action*.
- ECHO, European Commission Directorate General for Humanitarian Aid (June 2019). *Guidelines grant/contribution agreement with humanitarian organisations*
- ECHO, European Commission Directorate General for Humanitarian Aid (May 2020). *Framework partnership agreement with humanitarian organisations*
  - ANNEX III; *General Conditions*
  - ANNEX IV; *Rules and procedures applicable to Property, Supply, Works and Service Contracts Awarded within the Framework of Humanitarian Actions Finance by the European Communities*
- ICRC, International Red Cross and Red Crescent Movement (2014). *Market Analysis*



### Guidance

- ICRC, International Red Cross and Red Crescent Movement (2014). *Rapid Assessment for Markets*
- SC, Save The Children; Procurement guidelines
- ACF, Action Against Hunger; Supply Chain guidelines
- [PARCEL Project](#)
- [Humanitarian Logistics Association \(HLA\)](#)
- [Core Humanitarian Standard](#)
- [Universal Logistics Standards in Humanitarian Logistics \(ULS\)](#)
- [ULS Procurement Handbook. Universal Logistics Standards](#)
- [Procurement Standards. PARCEL Project \(Partner Capacity Enhancement in Logistics\)](#)
- [The Cash Learning Partnership \(CaLP\)](#)

## Customs

### Common Terms in Customs

<b>Export</b>	Physically and legally transmitting goods from a the boundaries of a country or national territory.
<b>Import</b>	Physically and legally transmitting goods into the boundary of a country or national territory.
<b>Reexport</b>	Exportation from a customs territory of goods previously imported into that territory
<b>Bonded Storage/Transport</b>	A method of storing or transporting goods that have either already been exported from an national territory, or have yet to be imported. The warehouse or truck are "international grounds."
<b>Clearing</b>	The act of lawfully importing goods through a recognised import authority.
<b>Agent</b>	Any third party who works on behalf of a contracting party. Most common in customs clearance are "clearing agents" and "forwarding agents."
<b>Frustrated</b>	Cargo that is held up and unable to be imported to a country or territory for whatever reason.

---

<b>Demurrage</b>	Fees that accrue from cargo behind held pre-customs. Frustrated cargo can greatly increase demurrage fees.
------------------	--

---

<b>Boundary</b>	The physical edge when entering or leaving a country or national territory.
-----------------	---

---

<b>Border</b>	The actual physical crossing point of a boundary.
---------------	---

---

<b>Port of Entry</b>	Port through which goods are imported.
----------------------	--

---

<b>Import Fees/Duties/Tariffs</b>	The legally required fees charged by governments to import goods. Each country has vastly different regulations.
-----------------------------------	--

---

<b>Exemption</b>	When part or all of the import fees and / or process are exempted for specific goods or organizations, usually in response to extraordinary circumstances.
------------------	--

---

## Customs and Humanitarian Aid

Any physical good crossing the national boundary or entering the incorporated territory of any country is obliged go through at least some level of government control procedure and formalities. These formalities are colloquially known as “customs,” however there may be specific agency names for each country in question. Customs regulations in virtually all contexts will apply to all private individuals and legally defined entities within the legal remit of the respective country in question. These legal regulations can have far reaching implications for violation or failure to comply, including impound and seizure of goods, fines, arrest and detention and full criminal prosecution. Every country will have its own standards and regulations pertaining to import or export of goods related to economic, judicial or cultural mores within the territories in question. Any person or entity operating in any country for any reason must be aware of these regulations and endeavour to be in full compliance with them at all times, even if compliance means following the proper exemption process.

Humanitarian organisations are sometimes at an advantage for the facilitation of customs clearance in emergencies; not only are registered non-profits frequently able to apply for some forms of tax or duty exemption in non-emergency settings, during emergency responses many import regulations on humanitarian responders are waived or loosened by the countries affected by disaster, or adjacent countries to the disaster. The United Nations often assumes the lead role in making appropriate arrangements with governments regarding quick access to emergency supplies as the physical flow of emergency relief is supplies is essential in the early

days of response. The United Nations through the Office for the Coordination of Humanitarian Affairs (OCHA) has also developed a "Model Agreement" (approved by the Permanent Technical Committee in 1996) with the World Customs Organisation (WCO). The Model Agreement can be adopted by any country, and lay the foundation for the process of exemptions, streamlining paperwork, pre-identification and expedited clearance of certain relief items, and overall smoothing of the import and export process. The Logistics Clusters on behalf of the UN Resident Coordinator (UNRC)/ UN Humanitarian Coordinator (UNHC) may try to leverage these advantages for all humanitarian organisations in an emergency.

Some of the problems encountered by humanitarian organisations during emergencies are:

- Complicated customs procedures causing delays resulting in congestion at port of entry (airports, road borders, seaports) that affect turn-around time for feeder vessels and railway wagons, so affecting the flow of goods.
- High volumes of emergency supplies flowing into a country causing a bottle neck to customs.
- Complex and non-transparent administrative requirements, often pertaining to documentation.
- High costs for processing trade information.
- High level of stress and large number of shipments in a short time, that can lead to errors in documentation and lack of understanding of import requirements.

## **Role of Customs Authorities**

Customs relates to both the import and export of material goods. Import and export were classically limited to the transmission of physical goods across a legally recognised international boundary, however advances in technology and changes to trade policy have also grown to include - in some cases - the electronic transmission of electronic information such as proprietary software and even intellectual property such as manufacturing processes. Import is the transport of physical goods into the incorporated territory country, state, autonomous region, whereas export is the movement and shipment of goods out of said territory. To manage and oversee the legal and controlled import and export process, national authorities can and will identify and establish one or a limited few numbers of customs authorities which operate in the territory of the country in question and enforce national regulations. Depending on the country, customs authorities can have different names, and exercise different levels of both scrutiny and control.

An established customs authority or authorities are by definition the only government agencies mandated to take full control of trade imports and exports, however this distinction can be blurry or not fully respected in times of emergency or civil unrest. Agencies or persons operating attempting to import or export anything for any reason should be aware of who the relevant authorities are, and where responsibilities start and end.

As a direct extension of a national authority, a customs office through proactive enforcement:

- Protects the environment, and public safety, health and morality by barring international trade in illegal substances and materials e.g. narcotic substances, arms and ammunition, endangered animal species, hazardous wastes, and expired, counterfeit or sub-standard goods.
- Represents the political, economic and security interests of and takes legal direction from the central authority of the country, state or semi-autonomous region into and out of which goods flow.
- Generates revenue through collection and enforcement of trade tariffs.

- Liaises with other law enforcement agencies nationally and internationally to prevent trans-border crimes e.g. movement of drugs, stolen motor vehicles and smuggled goods.
- Enhances voluntary trader compliance through quality client service.
- Facilitates legitimate trade.

In its efforts to achieve, respond effectively and efficiently to the aforementioned challenges and reduce the gap between expected needs and limited resources, a given customs authority has to strategically train and inform customs authority employees, and collect and compile trade statistics and data. Customs administrations all over the world generally apply similar procedures and processes, and speed of clearance depends largely on what controls are required by legislation and the degree to which information and communication technology is applied.

## **Duties and Taxes Exemption**

In addition to enforcing national laws as regulated by the authorities of each country in question, customs authorities are also charged with the collection of duties and tariffs. The nature and types of these costs are variable from country to country, and are developed by national authorities to raise revenue off key economic activities, protect national industries, and even prevent spread of sensitive or security related items. Import and export duties are typically governed what are called “schedules”; duty/tariff schedules are typically accompanied by national legislation and are widely published and made available to commercial entities and transporters. These schedules are typically updated on a regular basis, and it is the duty of any agency or person importing or exporting anything to understand and adhere to these regulations.

Customs authorities may also collect certain fees and levies upon importation, based on agency basis, such as:

- Import declaration fees - on imported products.
- Revenue stamps - for certain transaction documents which, by law, require affixing of stamps.
- Petroleum development levy - on petroleum products.
- Registration fees - for first time importers.

The decision of exempting the goods imported into a country or territory for humanitarian purposes, from the payment of duties and other taxes, is entirely the decision of the country's authorities. At the on-set of an emergency, especially a rapid on-set emergency, there may be ad-hoc pieces of legislation from national authorities that impact the importation or duty process, ideally waiving duties or significantly easing the importation process. Because of their ad-hoc nature, these changes usually lack detailed instructions on the practical implementation. The absence of guidelines on how to apply ad-hoc legislation is due to the fact that most countries are not ready for emergencies in the specific area of customs.

Whether a specific donated item or commodities can be imported into a country without any tax payment depends on the local government's decisions about:

- National humanitarian aid import policy.
- Goods qualified under that policy.
- Actors granted with tax-free status.

It is essential that donors and decision-making organisations at origin are aware about the implication of taxes on operating costs as they develop their response strategies.

The customs authorities might not qualify every single entity as “of public interest” or “charitable” and grant the duty waived privilege associated with it. Humanitarian organisations dealing with local counterparts, must make sure that the local counterpart receiving the goods is a registered duty-free entity, and if local exemption is required, that their counterpart is the one taking care of the application for duty exemption and supplying all required documentation. For that purpose, the local counterpart must have the capacity to know the procedures, focal points and regulations within their administration, in order to lodge the application correctly. If they have not got this specific knowledge (what commodities are prohibited or restricted, quotas, etc.) or are just not familiarised with the requirements and paperwork, it is useful to ask advice at local ministries, other NGOs already operating, customs brokers, and tax experts. There are certain items globally that tend to cause more scrutiny than others, and may require special certification. Though regulations are country specific, exporters and importers should pay close attention to the following categories when planning response activities:

- Medicines and medical equipment – Countries tend to maintain an essential medicines list which denotes what may be restricted
- Vehicles and vehicle/machine parts – Regulations on vehicles may be used to protect local markets
- Communications equipment – Radios, satellite phones, VSAT, or even basic computers and smart phones
- Dual use items – Any item that could have perceived military uses, such as bullet proof vests or remote detection equipment
- Alcohol and tobacco products

There is a common misconception that exempted goods/materials are free from customs formalities. As any other type of cargo, all the relevant operations must be carried out by the persons concerned and by customs in order to comply with the customs law. Every shipment must be documented, and in the case of the exempted goods/material, this includes an additional requirement, which is the certification or proof of its status as exempted.

## Entities Involved

As goods flow out and into countries, there are a number of parties who may come into contact with or be involved with the handling and clearance process. A non-exhaustive list of parties who may be involved with customs import and export are:

**Shipper** – Any individual or legal entity who is coordinating, paying and/or legally acting as the owner of goods moved from one point to another.

**Consignee** – Any individual or legal entity who receiving a shipment. For international shipments, consignees must be legally registered in the country of reception, and are ultimately responsible for the paperwork, legality and reception of cargo. A consignee and a shipper can be the same entity. Cargo is legally in the name of the consignee, however depending on the contractual shipping arrangements, a third party may pay customs authorities directly for fees and duties, and may even pick up cargo at points of entry into a country.

**Notify Party** – Any individual or legal entity who is notified once an international shipment has arrived. Notify parties can be the consignee, or they can be identified third parties responsible for the clearance process. Notify parties don't need to be legally registered in any country, but should be in contacted with the consignee.

**Customs Brokers / Clearing Agents**– Clearing agents and brokers are individual or entities who facilitate the movement of goods through the customs process. Usually, they are private for-profit service providers who have some form of accreditation to facilitate customs in specific locations and contexts. Brokers and agents should be very familiar with customs procedures and spell out all paperwork needs. They also usually work on commission or for fees.

**Independent Inspection Companies** – Companies who conduct, visual, physical and even laboratory testing of incoming cargoes. Inspection companies are usually legally separate from the national authorities, and agencies undergoing clearance usually are expected to pay for inspection costs.

**Ground Handling Agents** – Companies or entities that are tasked with moving cargos on and off vessels, and around customs facilities. Costs for ground handling may be built into contracts, or directly billed towards the clearance process.

**Freight Forwarders** – Depending on the terms of the transport contract, freight forwarders may be directly responsible for customs clearance, acting as clearing agent.

**Customs Authorities** – Agents and direct representatives of the respective customs authorities in question. Depending on the contexts, customs officials may be heavily involved with every step of the process, or may outsource the process to other third parties. Customs authorities will have ultimate say on the process and legality of imported and exported goods.

**Other respective governmental authorities and departments** – Many government agencies might play a part in the import and export process, depending on the item, the circumstance or the parties involved, these entities might include the Ministries of Health, Agriculture, Ministry of Foreign Affairs, Ministry of Finance, Disaster Mitigation unit/office, Ministry of Communication, Military and Civil defense, or other involved parties.

## HS Code Lookup Tool

### Common Concepts in Customs

**Harmonised Customs Procedures** - Though regulations vary from country to country, there has been an effort to develop a standard nomenclature and numbering convention led by the [World Customs Organization the \(WCO\)](#). The more than 200 member states of the WCO have agreed on what is called a Harmonised Commodity Description and Coding Systems, or frequently referred to as the Harmonised System (HS) for short. The HS process has also been adopted and backed by the United Nations, through the Kyoto Convention or International Convention on the Simplification and Harmonisation of Customs Procedures ([Annex J, Chapter 5, specifically deals with relief consignments](#)). Last updated in 2017, the HS codes allow customs authorities and exporters/importers support clearance of goods through simplified and harmonised customs procedures, thus facilitating international trade. Shippers can learn more about the HS process and look up HS codes for specific products on the [WCO's online system](#).

HS codes are six digits long, and are derived directly from the WCO's classification system, however many countries use eight or even ten digits to accommodate both regional and national legislation. The structure of the HS codes is derived from:

Chapter	Heading	Sub Heading	Region Specific Codes	Country Specific Codes
94	04	21	00	00
Furniture	Mattress	Of cellular rubber or plastics	Region Specific	Country Specific

HS codes can be searched for and identified using the [HS Code Lookup Tool](#).

**International Commercial Terms (Incoterms)** – In the customs process Incoterms denote at what physical point cargo may be delivered to and who bears the responsibility for clearing customs. Incoterms range from the importer having to do all the work regarding transport and clearance (FCA) all the way to carriers clearing customs on behalf of the receiving agency and delivering to a named place inside the country (DDP). For information on international trade, see International [Commercial Terms used in international contracts of sale](#).



**Bonded Storage / Transport** – a bonded storage facility is any facility that holds cargo that has not yet been cleared for import into a country, or cargo that has been pre-cleared for export from a country. In real terms, the inside of a bonded facility “international territory” for any cargo stored there. Bonded facilities are usually highly regulated and guarded, and penalties for removing cargo from a bonded facility without proper clearance can be very high. As cargo is imported into a country, usually customs authorities keep cargo in a bonded facility of some kind prior to clearing customs. Third party companies may also maintain bonded facilities if they have special arrangements with their respective customs authorities, or they operate in some kind free trade zone.

Any time cargo in a bonded facility must be moved from one place to another without undergoing proper clearance, it must be transported with ‘bonded transport.’ The concept of bonded transport is the same as bonded storage – the items are not technically cleared for import, nor have duties been paid on them and as such bonded transport his highly regulated.

**Demurrage** – Demurrage is the accrual of fees on any cargo items that are left in the holding of a customs authority or air/port side operation after a pre-defined time. Cargo that arrives via air/sea/land border is usually given a specific period of time to undergo clearance without additional charge. The duration of the free of charge period and the daily/hourly rates varies location to location, and is negotiated between the national authorities, the company/authority authorised to run the air/seaport, handling agents, and the transport companies. Demurrage accrued from air and railway shipping typically begins with 1-3 days, while demurrage accrued sea shipping can start as late as two weeks after arrival. Importers should be aware of what their demurrage rates can be, as long-term delays can lead to significant costs.

**Reexport** – any time a cargo is imported into a country and then shipped again to another third country, it is defined as a “reexport.” Importers and exporters of goods must be aware of how reexports impact their operations. Governments may have import/export restrictions on specific good coming from or going to specific countries, either through regional politics binding international sections. Many governments view a reexported item as the same as coming from its original country, even if it passed through a different country in-between. Unwitting importers may accidentally import/export banned commodities, which can have legal and financial repercussions on both the consignee and the shipper.

**Frustrated Cargo** - Any shipment or cargo undergoing the customs procedure that is stopped and prevented from release for any reason. Frustrated cargo could be held up due to improper documentation, failure to meet payment, and attempted import of regulated or banned goods, and usually requires further disposition instructions or additional paperwork.

## General Customs Process

Prior to importing goods, agencies should conduct a thorough analysis of all customs guidelines and requirements, including any restrictions and the necessary documentation. Clearing agents/customs brokers and national authorities can help guide importers on the steps and documentation required. In emergencies where a national Logistics Cluster is activated, participating members can also share import relevant information as needed. In any situation – emergency or not – there should be a clear understanding of what steps are required and a clear plan of how to move.

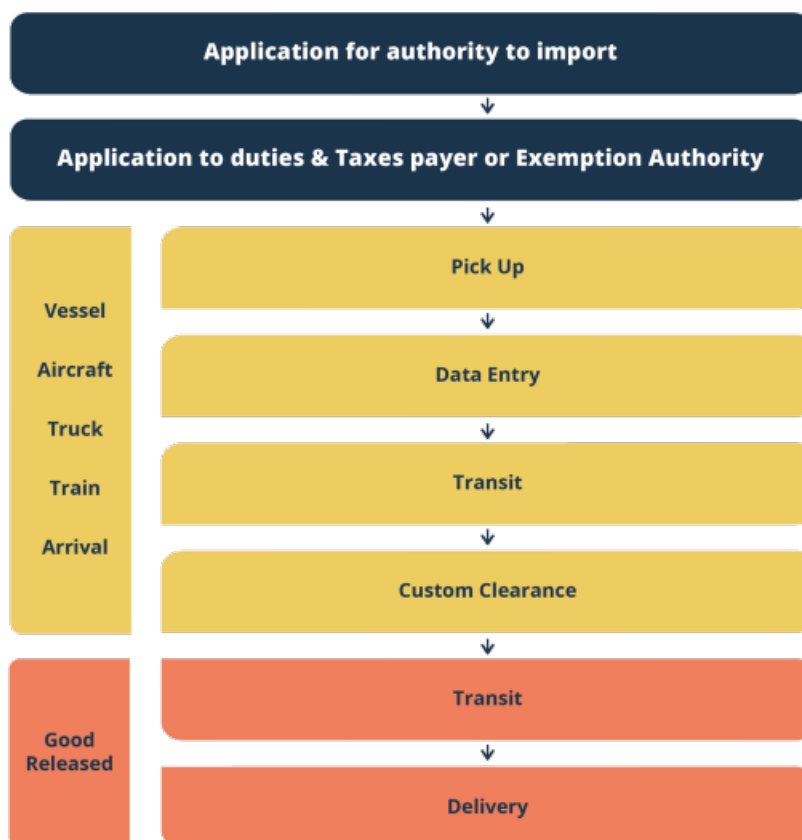



It should be noted that this process *may* be altered in the face of rapid-onset emergencies, but not *always*.

## Upstream Planning

As the need for international shipments develop, there are key steps that any organisation or entity initiating shipping will need to undergo. Response organisations acting as exporters/shippers will need to take key actions to obtain information and coordinate shipments:

### Data Required from Requestor/Receiver

- Receive specific information about the required shipment – Quantities, specific item types, required dates, and more.
- Clarify import/export regulations into and out of the countries relating to the shipment.
- Identify delivery terms, Incoterms and which parties are responsible for what stage of the customs process.
- Identify all documentation needs with the receiver and provide advanced copies to the consignee or customs agent before the shipment.
- If budgets are signed off by either or both parties, communicate potential costs for clearance and shipping.
- Establish viable transport methods (air, sea, road, rail) and identify delivery locations and dates.

### Shipment Preparation and Organization

- Work with vendors to properly identify HS codes, and fulfil all documentation, packaging and labelling needs.
- Understand national and international regulations surrounding both regulated or banned goods, and legalities around countries of origin/destination.
- Include physical copies of all required customs clearance documentation with the shipment.
- Ensure all required documentation is available, and (where available) double check physical cargo so that items, quantities, and dimensions match documentation.
- Solicit, identify and contract with a transporter, freight forwarder or other certified entity familiar with customs.

### Strategies for Emergency Response Organisations

- Work with respective program and operations teams to identify routine response activities and pre-define cargo that will likely be used in response activities.
- For propositioned stock, it is possible to pre-identify HS codes, shipping documentation needs, and screen against country level import regulations (example – WHO approved medicines list).
- Solicit and identify third party vendors who can rapidly provide the specific products required for response, and make agreements that include documentation and labelling needs.
- Develop agreements with forwarding agents and shipping agents to provide rapid transport service and information on customs and infrastructure bottlenecks.

# Downstream Planning

An organisation or an entity acting as importer or consignee intending to receive a shipment should also take steps to properly prepare and identify needs.

## Defining the Importation Process

- Any organisation used as a consignee for any shipment must be legally registered in the country of importation. The registration process varies from country to country.
- Wherever possible consignees should avoid listing single individuals as consignee, or using abbreviated or acronyms for agencies as consignee names.
- If necessary, solicit and enlist the services of a clearing agent/company that is duly registered and licensed by the customs authorities to process the import documentation through customs.
- Work with national authorities (customs, health, bureau of standards, border security) and/or contracted clearing agent to identify import regulations and requirements and share with the exporter/shipper.
- Work with national authorities and/or contracted clearing agent to understand all tariffs, duties, fees and possible exemptions.
- Define with the exporter/shipper the Incoterms and limits of responsibilities with the forwarder and/or contracted transporter.

---

## Preparing to Receive Shipments

- If the importer/consignee is also the requester, the importer/consignee should endeavour to provide as much information on the required cargo to the exporter/shipper as possible.
- Prepare for receipt, storage and inspection of the consignments in country.
- Understand the entry points and bottle necks associated with customs clearance.
- Have all documentation ready before consignment arrives.
- Expedite clearances where possible by pre-clearing using advanced copies of documentation.
- Track shipment and know when it arrives in country to avoid demurrage or lost cargo.
- Pre-identify transport to remove cargo from customs, ideally planned around the size of the shipment. Have adequate storage or down-stream deliveries planned as well.
- As soon as consignment arrives, arrange for inspection and clear the consignments through customs.

---

## Possible Customs Specific Regulations for Importation

- Temporary importation for use of items and re-exportation at a later date.
  - Provisional customs release pending perfection of the documentation at a later pre-defined date, e.g. pending exemption letter, certain permits.
  - Entry of re-exported cargo.
  - Entry of transit cargo, under security bonds.
  - Re-importation of cargo after temporary exportation for repair of maintenance.
  - Seizure and destruction of prohibited cargo.
  - Customs penalties/fines for incorrect declaration by consignees or their appointed clearing agents.
-

## Strategies for Emergency Response Organisations

- Liaise with programming and operational teams to assess needs, and use assessment outcomes to validate needs.
- If possible, apply for authorities and waivers for the exports and the imports.
- Attempt to expedite exemptions. Where exemptions are already given, immediately authorise shipment of consignments ensuring all the correct paperwork is in place and that the shipping instructions are appropriate.

## Documentation

The import process usually requires specific, and at times substantial documentation.

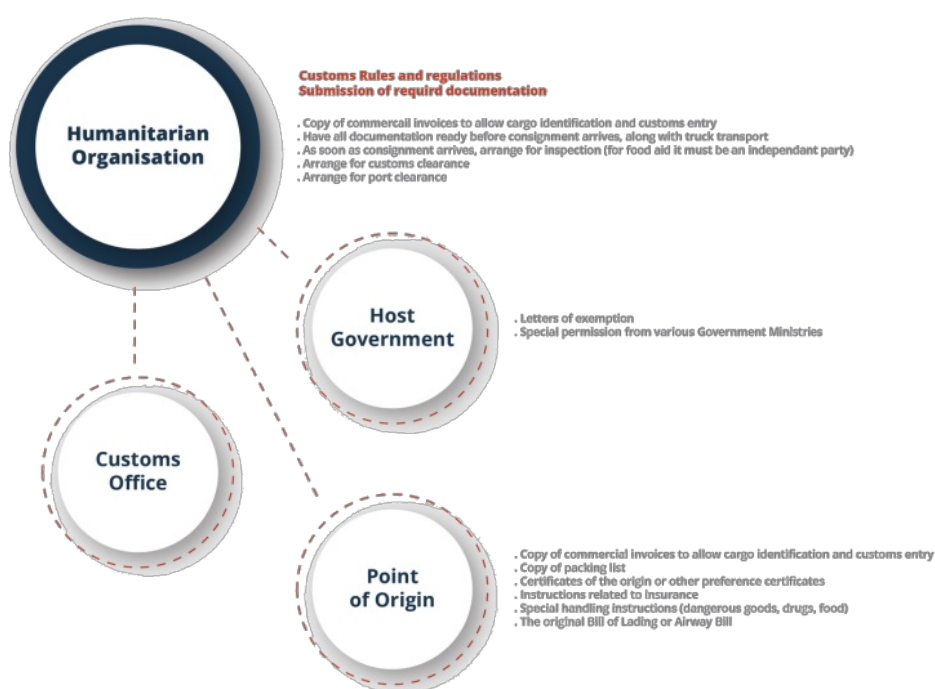

*NOTE: at all costs try not to have your consignment warehoused at the port. Where possible try and arrange for your own security*

In emergencies, the authorities will usually ask for originals or copies of the following documents:

- **Commercial / Proforma Invoice** – Indicates an overview of the contents of the shipment and the party responsible for procuring / paying for the cargo. Invoices typically list a total cargo cost which can be used for customs duty purposes. Many humanitarian agencies prefer to use self-generated proforma invoices to specifically indicate that the cargo will be used for humanitarian aid.
- **Packing List** – Should be detailed and accurate enough that customs officials don't need to inspect every item. Packing lists are typically far more detailed than invoices when shipments have a large number of line items.
- **Bill of Lading / Airway Bill / Rail Waybill / Trucking Waybill.**

Other Import documentation often required:

- **Letter/Certificate of Donations and/or Humanitarian Goods**- Many agencies will include self made letters of humanitarian intent or donation to help facilitate the customs exemption process.
- **Proof of duty exemption** - May be required at the time of clearance, usually a registered humanitarian agency should be able to obtain some form of letter from the relevant tax revenue authority. A letter may be required for every import, however.
- **Certificates of Origin (COO)** - Usually generated and certified by the manufacturer, but can be done by the sending agency if required. Some countries have strict source origin requirements.
- **Certificates of Inspection (COI)** - COIs are usually associated with regulated commodities that may be consumed by humans - example: Medication - or may have adverse effects on human health - example: flammable plastic shelter material. COIs typically require certification from an outside laboratory testing facility, certified to test the specific chemical properties of the items in question.
- **Certificates of Conformity (COC)** - COCs are used to confirm that products meet or exceed a certain industry standard, and require inspection by outside testing and certifying companies.
- **Phyosanitary Certificates** - Certification attesting that imported plant based material meets the sanitary requirements of the country in question, usually from an outside laboratory.
- Special handling instructions ([dangerous goods](#), [cold chain](#), [drugs](#), food).

## Port of Entry Procedures

Most large seaports and international airports have the capacity to carrying out customs inspections, storage and clearance on site. For customs clearance to be official, there will need to be offices designated to the relevant customs authority and space for storage of goods undergoing customs.

The main formalities connected with the handling of goods by authorities in the export or import trade are as follows:

1. Before any cargo is has a copy of the cargo manifest/packing list and BOL/AWB must be delivered to the relevant customs and port/airport authorities.
2. When cargo is discharged and offloaded from the ship/aircraft, it will be counted by a designated agent on the ground.
3. Wharfage and/or ground handling fees at the prescribed rates is levied on all goods arrived.
4. Goods not removed from the custody of the customs authorities within the free storage period allowed are charged rent at the prescribed demurrage rate.
5. Demurrage will be charged on any un-manifested cargo not removed within the prescribed time after delivery.
6. Failure to cover demurrage fees may ultimately result in cargo being sold at public auction.
7. Demurrage fees may be waived in cases of:
  1. Goods arriving in a damaged condition for which a claim is made against the carrier, some extension of free time may be allowed to enable a survey of the damaged cargo to be made.
  2. Goods damaged subsequent to offloading and for which an "Application for Survey" has been received by the port authorities.
  3. Goods are detained by the customs authorities for special examination, chemical tests, etc.

4. Removal of goods is delayed due to no fault or negligence on the part of the importers.
8. Areas used for the offloaded and storage of imported goods must be declared as Customs Areas under a Customs Act, and usually are bonded, highly secure facilities.
9. Storage of hazardous cargo will be permitted only in locations specially designated for that purpose.
10. Examination of cargo by Customs will be permitted only if the consignee or clearing agent produces to the port authorities the delivery order issued by the shipping agent together with the Bill of Entry prepared on behalf of the consignee.

For cargo arriving by air:

- Larger airports usually provide facilities inside designated Customs Areas for transit cargo to be de-consolidated and consolidated with local export cargo.

For arriving by sea:

- In the case of containerised cargo, containers may be unstuffed in the port area before the cargo is presented for examination by Customs. Alternatively, containers may be taken to an inland container depot, or warehouse, or factory of the consignee where they are unstuffed and delivered to the consignee after completing Customs formalities.
- Carting or transporting of export cargo, if it is Break Bulk, is permitted at the berth where the ship is ready to load. In the case of containerised cargo, carting is permitted to the location assigned to the shipping line by the port authority.
- Like imports, exports attract demurrage after the expiry of free time but port authorities sometimes waive this charge in the case of special cargo. Ports may defer acceptance of export cargo if there is a delay in the arrival of the vessel.
- When export cargo is taken to an inland clearance depot, Customs formalities are completed there and the cargo is stuffed into containers, which are then brought to the port for direct loading onto the ship. The same procedure may also be followed if containers are stuffed at the factory or warehouse of the shipper.

When planning arrival of cargo, it is extremely important to know if customs is an option, especially in post rapid-onset emergencies. There may be instances where planes or boats may be physically able to arrive at a seaport or airport, but not actually able to legally import goods.

## **Clearing Goods**

The following steps detail the process through which cargo is handled and inspected by customs after arrival and offloading:

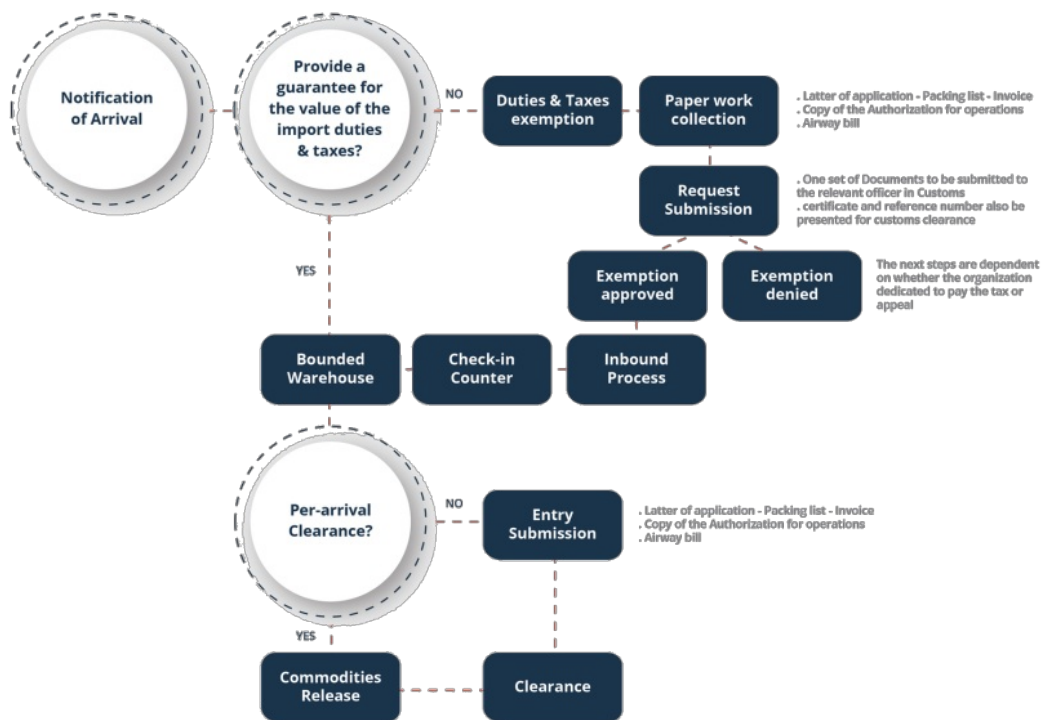

1. All imported cargo must be offloaded at a designated Customs port and should not be removed from customs control without written permission of the customs authorities.
2. Before permission is given to remove goods from customs control, the owner or agent acting on the owner's behalf is required to submit documentation as required by law, in the prescribed form to enable customs authorities to examine the goods. The specific cargo details must match across all documents.
3. When goods are destined for bonded warehousing, application for permission to warehouse those goods and a bond must accompany the documentation.
4. Customs authorities are empowered to examine all imported goods. The examination may be physical (visual inspection, counting, weighing, measuring, chemical test, etc.) or documentary (involving examination of relevant documents such as invoices, bankers' notes, insurance policies and forms listing the quantity and description of goods).
5. If goods are dutiable, either customs tariffs must be paid at the time or the importer must give a bond to guarantee payment of the duty.
6. If goods are not removed within the prescribed period after the arrival of the importing vessel or aircraft, they are liable to be sold at public auction by the port authorities who will recover from the sale proceeds all charges due to them, including customs duty.
7. Customs authorities are entitled to recover from the importer any shortfall in duty levied or erroneous refund of customs duty, in accordance with prescribed procedures and laws.
8. In cases where import licenses are required, customs authorities will check the legality of the imported goods against those licenses.
9. Once the local customs authority has deemed all paperwork and payment sufficient, the consignee or consignee's acting agent will be able to pick up cargo from the designated cargo facility.

Customs authorities will use paper copies of all associated documentations - and depending on the context and the capacity of the customs authority, electronic copies - to identify cargo going through the physical inspection process.

If the importer or the customs broker acting on their behalf fails to obtain paperwork by the time customs clearance should begin, the submission procedure will be delayed, and the release of cargo will be delayed or not happen at all. The consequences of frustrated cargo result in delays in the delivery to beneficiaries, or additional costs such as demurrage. Within a short period of time, large amounts fees can accumulate for which the receiver is held accountable.

## Methods of Payment in Import/Export

**Letters of Credit (LC)** - A letter of credit is an undertaking by a bank to make a payment to a named beneficiary within a specified time, against the presentation of documents which comply strictly with the terms of the LC. The parties to a LC are usually a beneficiary who is to receive the money, the issuing bank of whom the applicant is a client, and the advising bank of whom the beneficiary is a client. Almost all LCs are irrevocable, they cannot be amended or cancelled without prior agreement of the beneficiary, the issuing bank and the confirming bank, if any. Typically, the documents a beneficiary has to present in order to receive payment include a commercial invoice, international waybill of some kind, and insurance documents. However, the list and form of documents is open to interpretation and negotiation, and there might be requirements to present documents issued by a neutral third party evidencing the quality of the goods shipped, or their place of origin.

**Electronic funds transfer (EFT)** - An EFT refers to the computer-based systems used to perform financial transactions electronically. Most governments and customs authorities will prefer EFTs, and usually have a designated bank account for all deposits. A government managed bank account has the advantage of enabling transparent monitoring of funds transfer,.

**Cash Payment** - In very rare circumstances, customs authorities will request cash payments. Though it is becoming less common, cash based payments can occur, especially in the aftermath of rapid onset natural disasters. Wherever possible, cash payments customs clearance should be avoided as they are hard to trace and may lead to fraud. If a cash payment for customs is required, organisations should request a receipt in full, detailing what each individual fee was for and the official within the customs authority with whom the transaction occurred.

## Order of Payments and Risk



- **Payment in Advance** - All import duties, fees and handling charges are paid in advance.

In the event there are changes to the items, quantities or the overall anticipated fees are incorrect, the entity paying up front bears additional risk. If payment in advance is required, importers should try to use a letter of credit.

- **Documentary Credit** - The technical term for letter of credit.
- **Documentary Collections** - Instruction from an exporter (seller or supplier) to a remitting bank, normally the exporter's local bank, to collect payment immediately or at a future date from an importer (buyer) against delivery of the relevant commercial documents. Documentary collections function like a letter of credit, however the burden of documentation and values are supplied by the seller/exporter. Importers should still monitor these communications to ensure agreed upon costs are still being used.
- **Open Account** - An agreement between an importer and an exporter whereby goods are supplied on the understanding that payment will be effected at an agreed future date. Payment can be made after goods have been imported. This method is used when there is a high level of trust between exporters and importers.

## Customs Tools and Resources

### Templates and Tools

[TEMPLATE - Certificate of Origin](#)

[TEMPLATE - Donation Letter](#)

### References

- Country specific customs information can be found at the Global Logistics Cluster, [Logistics Cluster Assessment \(LCA\)](#) country pages.
- [Customs Model Agreement Between UN and State](#)
- [Kyoto Convention. Cp. 5 Annex J - Relief Consignments](#)

## Transportation

### The Role of Transport

In the humanitarian context, transport is defined as:

“ **The activities involved in moving supplies from point of origin to internal customers or beneficiaries**”.

The role of transport is to facilitate the movement of physical goods. In the humanitarian context, this might include:

- Transport from manufacturing facilities, donors, and storage or pre-positioning locations
- Delivery to regional warehouses, country level warehouses, offices and distribution points
- Carriage between warehouses, hubs and field locations

The source and destination may be in the same country, or one may be in a different country requiring international movement.

The rapid growth of technology and the changes in the delivery of humanitarian aid has done little to change the fact that relief supplies still have to be collected and delivered via some



physical form of the transmission. Even though new technologies have enhanced the speed at which cargo can be transported or monitored, the basic concepts surrounding transportation have remained largely the same for many years.

Historically, the transportation of supplies has been regarded as an ancillary function of little or no central importance. More recently, efficient transportation has been recognised as an essential determinant in providing consistent, quality service to beneficiaries. A good transport system fulfils the "rights" of supply chain management. That is:

- The right good.
- Delivered to the right recipient.
- In the right quantities.
- In the right condition.
- At the right location.
- In the right time.
- For the right price.

In an ideal scenario, goods will arrive as scheduled, at the right price, in maximised loads with no breakages or pilferage.

Summarising this thinking into a series of actionable steps, and successfully implementing those steps, will ensure timely and effective delivery of humanitarian assistance. A good transport system complements an efficient distribution system.

## Common Terms in Cargo Transport

<b>Shipper</b>	The person or legal entity that is sending the goods from point of origin. The shipper does not have to be the owner of the cargo. The shipper can also be referred to as the sender.
<b>Carrier</b>	The person or legal entity that either owns the vehicle or vessel upon which cargo is transported - or "carried" - or has legal responsibility for physical stewardship of the cargo between two points.
<b>Receiver</b>	The person or legal entity that is duly authorised to receive cargo on the receiving end. Receivers are also sometimes called "consignees," however the term consignee has specific legal meaning in customs proceedings, while a receiver is more generic could take possession of cargo through a variety of means, domestic or international.
<b>Agent</b>	A person or legal entity who is legally and contractually designated to act on behalf of a shipper, carrier or receiver. Agents can act in a variety of functions, from handling goods to processing documentation.
<b>Service Provider</b>	Any contracted third-party entity that offers a service, usually on a for profit basis. A service provider may be involved in a variety of activities, including being an acting agent or a contracted carrier.

---

<b>"Take Possession"</b>	When physical goods are transmitted into the direct care and stewardship of one party, be it a transporter, a warehouse, or customs, that party is said to have "taken possession" of the cargo. Taking possession does not mean the party holding the cargo then owns the cargo, they are only physically holding it for their part of the transport process.
--------------------------	--

---

<b>Intermodal</b>	Any form of transport that changes between two or more modes of transport. Intermodal transport can be facilitated through the use of containerised shipment, however cargo can also be transported through intermodal means simply by directly loading and offloading through a variety of means.
-------------------	--

---

<b>Material Handling Equipment (MHE)</b>	MHE is any form of mechanical equipment used to facilitate the loading and offloading of cargo, or the movement of cargo around an open space such as a port or a warehouse. MHE includes forklifts, cranes, pallet jacks, and more.
--	--

---

<b>Incoterms</b>	Incoterms - "International commercial terms" - are mutually agreed upon international shipping terms that designate responsibilities, risks and limitations of shippers, carriers and receivers. Incoterms generally are only applicable and enforceable for international shipments.
------------------	---

---

## Managing Transport

### Developing a Transport Strategy

A transport strategy in a humanitarian context varies from one organisation to another and from one situation to another. and is largely dependent on the needs of the response. Some factors to consider when developing a transport strategy are:

- How to identify transport service providers.
- How to manage transport – self managed or third-party provided.
- Capacity of transport modes available.
- Quantities of goods requiring movement over time.
- Nature of goods/products/supplies to be transported.
- Distances to be covered.
- Environmental issues such as climate, government legislature, and infrastructure.
- Number of destinations, hubs and pre-positioning locations.
- Origins, routes, and destinations.
- Available transport modes & their relative costs.
- Human resources available.
- Security along the transport route.
- Special circumstances, such as the nature of disaster.

The above factors would be valid for both emergency and non-emergency situations.

Transport management in emergencies can be a complex task depending on the nature of the disaster. Humanitarian organisations have increasingly begun to use the joint transport services as a strategy in emergencies, such as those implemented by the Logistics Cluster

during emergencies. A joint transportation service is based on a collaborative approach and aims to leverage the advantages of centralised coordination and sharing of assets.

## Organizing Transport

In emergency contexts, transport can logically be divided between domestic/local transport and international transport. The general concepts around domestic and international transport remain largely the same, however special considerations are required for both.

**Domestic transport movement** - Local movements within a specific country will usually involve road transport, however rail, air, river and even at time sea transport can occur in domestic movement. This may involve movement of palletised/bulk loads from ports, airports and rail-yards to warehouses and depots, palletised/bulk movements between facilities such as warehouses or depots, or delivery of smaller consignments from a local warehouse or depot to end users at a number of destinations in an area. Domestic transport requires actors to follow all local laws and safety regulations.

**International movement** - International transport requires the transmission of physical goods across a legally defined international border or boundary, and in most normal circumstances requires undergoing standard customs procedures. The local market will not always be able to provide all the products and services required to fulfil the needs identified in an emergency response. Response agencies will therefore source goods externally and organise the transportation of relief supplies to affected locations. To ensure efficiency and compliance with import regulations the organisations seek service providers with expertise and capacity to handle certain aspects of the movement.

## Mode of Transport

A mode of transport is the means by which goods and material are transferred from one point to another. The basic modes of transport are:

1. [Air](#)
2. [Sea / Riverway](#)
3. [Road](#)
4. [Rail](#)

See below a mode comparison matrix for different modes.

	<a href="#">Road</a>	<a href="#">Rail</a>	<a href="#">Sea/Riverway</a>	<a href="#">Air</a>
<b>Relative Speed</b>	Moderate	Moderate	Slow	Very High
<b>Reliability</b>	Good	Good	Limited	Very good

	<u>Road</u>	<u>Rail</u>	<u>Sea/Riverway</u>	<u>Air</u>
<b>Cost per kg</b>	Medium	Low/Medium	Low/Very Low	High
<b>Flexibility</b>	High	Low	Low	Medium
<b>Other Considerations</b>	Extensive Network  Short and medium distances from neighbouring country to operation site; internal transport for short and medium distances	Limited and fixed infrastructure  Large consignments from port of discharge to inland operation site; ecological	Restricted Network  Large quantities; less urgent; pre-positioning phase; long distances with no time constraint	Limited Network  Emergency phase; expensive goods; fragile or perishable goods; cold chain; no alternative option; small shipments; e.g. diplomatic pouches; long distance with time constraint.
<b>Advantages</b>	Relatively fast; no transshipment; direct delivery; flexible; cost	Economical; large loading capacity; range and speed (context depending)	Economical; large loading capacity; no restriction on loading capacity; cheap	Fast; reliable; limited losses; direct; easy tracking and tracing
<b>Disadvantages</b>	Roads may be dangerous or blocked; sometimes driver nationality or vehicle registration not acceptable	Difficulty finding freight cars; frequent delays; transshipping required; inflexible; limited tracking	Slow; transshipping at ports; use as a second means of transport at high volumes; higher theft risk in ports; not flexible	Expensive; restricted to journey's between airports; restricted loading capacity; special considerations (dangerous goods, size limits, packing, etc.)

In emergencies, the criteria of speed and reliability must be examined when considering the choice of mode. Different modes have quite different characteristics and will need to meet the speed/reliability/cost criteria to varying degrees. The appropriate mode must be carefully selected if it is to match all the requirements. Multi-modal solutions may provide the most effective and efficient transport option.

Whilst the physical characteristics of certain goods and supplies may determine a specific

mode of transport, most goods will be capable of being moved by a variety of modes. Customer requirements and constraints on the organisation providing the transport must be considered. In humanitarian aid situations, it is often environmental factors, such as the destruction of roads and railways that have a significant impact on mode selection.

It is important to fully recognise the operational characteristics of the mode or modes that have been selected. It is also necessary to consider the type of vehicle or equipment that will be used within that mode. Prior to making a decision on the mode of transport, it would be useful to create a matrix ranking of influential factors for choosing transport modes. Some factors to consider in the rating:

- Required delivery date
- Cost of transport service
- Reliability and service quality
- Shipment size and item type
- Anticipated transit time
- Number of transshipment points
- Range of different services offered by a third-party provider
- Modes that realistically cannot be considered should be ruled out of the decision process immediately
- Geographical factors should be considered, as they may remove the opportunity to use a particular mode
- Lack of appropriate infrastructure may also remove the opportunity to use a particular mode

## Standard Documentation

Outside of highly specialised forms of documentation utilised for different modalities of transport, there are several widely accepted documents used in virtually all methods of transport. The purpose of utilising widely accepted documents is enact some form of traceability and accountability for cargos in transit between all parties who may handle or store the cargo. Widely accepted cargo tracking documentation methods should not be confused with the wide variety of specific documentation required for customs clearance. Customs clearance documents are generally required to certify conformity with national laws, help facilitate tariff revenue, and may be different from country to country. At the very least, agencies should consider using some form of the below documents for all shipments, even domestic shipments between their own managed facilities:

**Waybill** – A waybill is the ultimate informal “contract” between the sender, the carrier and the receiver of goods. A waybill should contain all relevant information for the shipment itself, including:

- The contents of the shipment.
- The point of origin and destination.
- Names of the shipper/sender, the carrier/driver, and the intended recipient.
- Dates of the transaction.
- Important information pertaining to the goods; special handling requirements, delivery instructions, etc.

When issuing waybills, one copy should stay with the sender, and at least two copies should travel with the carrier. When cargo is delivered on the receiving end, one of the copies travelling with the carrier should stay with the receiving party providing a transparent paper trail of what should have been on the vessel/vehicle and when it arrived to whom. Ideally, the

sender will fill out and generate the waybill, the transporter will cross check contents and confirm the items are correct, and the receiver will cross check and confirm again, noting any discrepancies. Some aid agencies prefer to receive a copy of the waybill signed by the receiver before closing the books on that individual shipment. If a third-party transporter is used, agencies may withhold payment until the countersigned waybill is received in good order. Waybills may also sometimes be referred to as “cargo manifests.”

**ORGANIZATION  
LOGO**

# WAYBILL

Date: \_\_\_\_\_ Waybill # (if applicable)

Transported From: \_\_\_\_\_ [Sending location]

Transported To: \_\_\_\_\_ [Receiving location]

Transported via vehicle: \_\_\_\_\_ [vehicle registration number or ID]

Hand Carried by: \_\_\_\_\_ [Name and ID]

Number of Units	Unit Type <small>(carton, piece, etc)</small>	Item Description / SKU	Project Intended For

Remarks: \_\_\_\_\_

Released by: \_\_\_\_\_

Dispatched by: \_\_\_\_\_

Received by: \_\_\_\_\_

\_\_\_\_\_  
Signature

\_\_\_\_\_  
Signature

\_\_\_\_\_  
Signature

Two copies to travel with the consignment, one copy kept on file

Title  
 Download - Template Waybill  
 File

**Packing List** – The packing list is a more detailed document that contains key information on the consignment itself. Packing lists might contain:

- Detailed piece counts per line item.
- Unit dimensions.

- Batch/Lot numbers or dates of production/expiry.
- Kit contents and components.
- Part numbers.

Depending on the nature of the consignment, packing lists could be multiple pages long and have high volumes of information. A detailed packing list will help senders, carriers and receivers accurately identify the quality and status of the consignment. A waybill may only contain an overview of the goods, while placing more emphasis on data surrounding who and when the consignment changed hands. A packing list should contain as much or as little information required to successfully convey the full state of the goods in the consignment.

**PACKING LIST**

Page 1 of 1

ORGANIZATION  
LOGO

<b>Sender:</b>	<b>Consignee:</b>	Date: _____
Address: _____	Address: _____	Invoice Reference No.: _____
Contact Name: _____	Contact Name: _____	Waybill Reference No.: _____
Tel: _____	Tel: _____	
Email: _____	Email: _____	

Item Description / SKU	Unit Type <small>(units, pieces, etc.)</small>	Number of Units	Dimensions (cm)			Unit Volume (m <sup>3</sup> )	Unit Weight (kg)	Unit Value (USD)	Batch/Lot	Expiration Date	Total Item Volume (m <sup>3</sup> )	Total Item Weight (kg)	Total Item Declared Value (USD)
			L	W	H								
1													
2													
3													
4													
5													
6													
7													
8													
9													
10													
11													
12													
13													
14													
15													

Total Volume (m <sup>3</sup> )	Total Weight (kg)	Total Declared Value (USD)

Name: _____	Signature: _____
-------------	------------------

Title

Download - Packing List

File



**Invoice / Proforma Invoice** – Invoices and Proformas are typically only applied when goods are coming from a vendor, or when goods are physically transported across a national border. For domestic movements, the invoice largely contains financial information relevant to the consignment, and should designate if goods have been paid for or not. Proformas are largely only used when attempting to obtain duty free status during import, and as such aid agencies will only likely be producing proformas during the customs phase.

ORGANIZATION  
LOGO

# PRO FORMA INVOICE

Page 1 of 1

Date: \_\_\_\_\_

Pro Forma Invoice Number: \_\_\_\_\_

<b>Sender:</b> Address: Contact Name: Tel: Email:	Method of Dispatch:	Type of Shipment:
	Port of Loading:	Port of Discharge:
<b>Consignee:</b> Address: Contact Name: Tel: Email:	Additional Information:	

Reference No	Item Description	Number of Units	Unit Type <small>(cans, pkcs, etc)</small>	Unit Price	Total Declared Value
				Total Value This Page	
				Total Value Shipment	

Name: \_\_\_\_\_

Signature: \_\_\_\_\_

Title

Download - Proforma Template

File



Templates of the standard documentation can be found in the [reference section of this guide](#).

## Managing Transport Service Providers

Humanitarian response organisations have increasingly begun to rely on external transport providers. An external transport provider is defined as any third-party who can carry or identify vessels that can carry cargo through commercial means. In the event third-party transport providers are contracted, there has to be a structured approach to the selection process, similar to other forms of procurement, and subsequent monitoring and control of the provider or providers selected. There are a number of important issues to be considered to ensure that a reputable provider, who will provide the adequate level of service, at an acceptable cost, is



sourced.

The selection process adopted for the acquisition of all services is covered by the organisation's approved procurement policy, processes and procedures. Ideally, contracting should be done in a competitive manner, on market terms, and negotiations undertaken in an open and transparent fashion, thus ensuring cost effectiveness and equal opportunities for the appropriate commercial entities.

There has also been an increasing level of attention to the ethical standards of contractors, including their facilitation and participation what would be considered violations of state and national laws, human rights abuses, or their involvement with parties to conflict.

### **General Transport Service Provider Selection Criteria**

The criteria for selection will vary from organisation to organisation. Some factors that may influence the selection of transport service providers are:

- Carrier characteristics and capacity.
- Proven efficiency.
- Timeliness of delivery.
- Known integrity, reputation and reliability.
- Good relationships with other carriers.
- Financial viability to cover costs of providing the service.
- Ability to provide a multi-modal service, if need be.
- Presentation of timely reports and correct invoices.
- Licensed by the government to conduct customs clearance formalities and be up-to-date on changes in customs requirements.
- Own or have access to a bonded warehouse to protect and control shipments in transit.
- Own a trucking fleet for inland transport and have access to specialised vehicles when needed such as container trucks, low-bed trailers, tankers, etc.
- flexible in their availability at short notice, also outside of office hours and on public holidays.
- Have influence in the transport market, with port authorities, etc.
- Experienced in successfully handling duty exemption arrangements for humanitarian organisations.
- Have an office in the port area or nearby.
- Have at least a country-wide, preferably a multi-country regional network.
- Use technology effectively, including a good telecommunications system and, preferably, a computerised tracking system that allows visibility of where shipments are at a given time.

## **Typical Service Providers**

Although it is advisable to use an intermediary such as a freight forwarder or clearing agent to handle international movements, it is still important to have a basic understanding of the roles of other third-party service providers involved in international movement.

**Private Transport Companies** - Private companies that own and operate vehicles such as trucks or planes directly. Many private transport companies have direct sales and customer service components, in particular small scale, local transport companies. Other companies, such as major airlines may not have the time or capacity to manage direct customer sales, and prefer to go through brokers or forwarders. A direct relationship with a transport company can certainly save costs, but for any services that require complex intermodal solutions that may

not all be owned by the same company, or in situations where customer service is inadequate, contracting forwarders might be the best solution.

**Freight Forwarders** – Commercial third-party companies or individuals that act as brokers between transport companies, customs agents, logistics providers, and other commercial services that might support packaging/handling, warehousing, transportation, or any other aspect of moving material goods from one place to another. Unless a requesting agency has well defined transport routes and a detailed understanding of the shipping market, freight forwarders are essential for identifying and pricing transport options, especially in chaotic post emergency settings. Forwarders have contacts within the transport communities and know how where to look for the best shipping options.

**Clearing Agents** – Commercial third-party companies or individuals who specialise in understanding import and export regulations, and help facilitate the flow of material goods through customs. Though clearing agents may be used for import or export, the majority of their services are employed for getting goods into countries. Import and export regulations are complex and the failure to comply can result in fines or other difficulties. Many countries require an official licensing process for clearing agents, and unless organisations have specific expertise in customs agents should always be consulted for imports of any kind.

**Inspection Services** – Private third-party services that conduct inspection on goods in transit. This may include physical counting, damage inspection, laboratory testing, inspection of batch/lot/expiration, validating specifications, etc. Inspection services may be required for importation, but many agencies employ inspection services during upstream transport, especially at the point of procurement.

**Third Party Logistics Provider (3PL)** – Commercial third-party logistics providers that can assume a portion of or the entire supply chain. 3PLs can act on behalf of contracting agencies for a variety of services, including warehousing, kitting, procurement, quality inspections, transport and even developing supply chain strategies without providing a physical service. 3PLs tend to be more expensive, but can offer holistic solutions to agencies who may need additional support.

The aforementioned service providers are all for profit companies, and as such the regular procurement process for each respective agencies should still be applied. It is generally recommended that agencies obtain multiple quotes, review performance, and incrementally conduct new bid analysis.

Other related parties frequently encountered with cargo operations are:

- **Customs Officials** – Agents designated by the national authority of countries to facilitate the lawful transmission of items into incorporated national territory.
- **Airport / Sea Port Authorities** – Government lead or appointed authorities who oversee the safe and efficient operation of ports of entry, including coordinating positioning and movement of vessels and aircraft and ensuring security measures are enacted on behalf of the national authority in question.
- **Ground Handling Agents** – Government run or privately contracted services who manage ground handling at airports and seaports. Ground agents are usually sub contracted and coordinated by forwarders or the airlines, however occasionally humanitarian agencies may need to liaise directly with them to solve problems.

## Planning and Scheduling Movement

Routine movements, taking place on a regular basis, need to be planned at the outset. Non-

routine movements occurring on an ad-hoc basis will have to be planned when the need arises. Ideally movements should be planned and managed by a transport office or dedicated focal point responsible for determining the appropriate routing for the goods, allocate resources (own or contracted) and inform the destination of estimated delivery time. During movement designated focal points will track the progress of the goods and update delivery times accordingly and will manage the staff involved in the movement and deal with any issues that arise. They will also handle any problems that occur during the movement, liaising with contractors, freight forwarders and shippers as required. The transport office may have to produce the required documentation to cover transit, alternatively they will be responsible for collecting the required documents together for dispatch.

Once movements have been planned and are initiated, it is important to maintain an information flow between all parties involved to ensure the safety and security of the goods and the adherence to service as promised. In environments within which humanitarian aid organisations operate, many events can impact the efficient movement of goods. In natural disaster or conflict zones, the risk to the movement is potentially high. Having up-to-date information on the status of the movement allows problems to be quickly identified and dealt with. Movements in a national context can usually be managed more closely than movements between or across countries. National movements can be usually planned and coordinated more easily while international movements will often be managed by one or more third parties, working in different time zones and in different languages. Often, international movements are planned and managed by a freight forwarder or logistics service provider working within the broad plan to meet the client requirements in terms of movement time and routing.

In addition to identifying the primary methods of transport, aid agencies should consider the smaller intermediary steps. As an example, even though an agency may be able to identify an international air transport method into a country, will there be available trucks to adequately pick up and transport cargo from the airport of reception? The same applies for multiple steps in the process, including the ability to identify adequate warehouse space, the ability to understand and comply with import regulations, and generally be able to accommodate all steps of the supply chain, not just the one step in question. Frequently, aid organisations are operating in a “push” model early in a disaster, and persons associated with organizing upstream transport are not necessarily taking directions from or even communicating with the persons engaged in downstream planning. Proper planning throughout all stages is vital to a good transport strategy.

## **Cargo Insurance**

Insuring cargo while in transit can be complex for aid agencies, especially when multiple forms of transport are involved across multiple countries, and into areas of heightened risk, such as natural disasters or protracted armed conflicts. For many agencies, the single largest expenditure of their response activities is the pipeline of relief items heading to affected populations, and proper care should be invested into maintaining this pipeline through risk mitigation measures. Generally there are two approaches organisations use for insuring cargo:

- Relying on insurance provided by the third-party transporter
- Developing a self-managed insurance plan

The risk of using a self-managed or third-party transport provider in the required area must be assessed prior to the appropriate insurance being taken out. In moving goods – especially to and within high risk contexts - there will be potential risks of theft or loss of the goods.

## Third-Party Transporter Insurance

Transporter provided insurance can be useful in that it provides coverage for short term gaps, for specific activities that self-insurance isn't designed for, or last mile activities that have enhanced risks. Cargo may be covered by the overall shipping terms of a contract with the third-party transporter, but it is strongly advised that all organisations relying on third-party transporter provided insurance to confirm the insurance status and requirements with the sender/owner of the goods to be moved. Shippers should understand the level of insurance that the provider will offer to cover the goods it carries on behalf of its clients; often if any insurance cover is offered, it will be fairly nominal and only cover a portion of the real cost of the items.

To ensure that freight insurance is properly applied, the full real value of the cargo must be declared to the third-party transporter prior to shipping and the costs and inclusion of insurance must be transparent, being included on any invoicing, and partially expressed through the Incoterms when in use. Many shippers also include the value of the transportation itself as part of the "value" of goods, as any loss or damage due to accident or negligence on behalf of the transporter will also result in the lost cost of the transport service itself. If a catastrophic loss should occur, ideally the shipper will be able to recover the full value without external litigation. Shippers should express a desire to insure cargo through the carrier/third-party when soliciting transport from brokers and forwarders to ensure service is available up front, and normally third-party or carrier provided insurance is negotiated through the forwarder.

There may be instances where organisations develop long term transport contracts with third-party providers, through which the shipper may not know the full value of every shipment over the contracted period. Such arrangements might be common in landside trucking contracts, which might go for a year or more over a changing response. If organisations wish to utilize insurance provided through the transporter in this case, they will need to develop a strategy to account for potential values of future cargo. This might include designating a maximum ceiling of coverage for any given movement that is roughly equal to or higher than any possible load, or develop a scheme through which cargo value is declared per movement and the third-party transporter adjusts billing accordingly. Organisations should never assume long term contractors will factor different insurance needs into quoting, and should be transparent in the bid process to avoid confusion later on.

Individual cost of third-party provided insurance may be influenced by the reputation of the transporter. In setting up contracts with providers, it is important that the type of insurance be clarified and incorporated in the contract terms. If there is any doubt as to the cover provided, advice from the organisation's office handling insurance should be sought. If insurance costs differ for different transporters, these should be included in the overall cost comparison matrix.

Key elements organisations should consider:

- Type of insurance: What is covered and to what extent, and where do responsibilities start and stop for the transporter?
- Duration of insurance coverage
- The overall process for reimbursement and payment

For long term, open-ended contracts:

- Scope: does the insurance cover all potential contexts of operation? What if a transport

- requires operating in more than one country?
- Does the insurance accommodate changing risk conditions?

## Self-Managed Insurance

Some humanitarian agencies have opted to develop a global self-managed insurance schemes in the form of self-insurance or some form of “blanket insurance.”

A self-insurance scheme for cargo requires a fairly robust accounting system, whereby organisations intentionally add costs to budgets for cargo movement, but simply keep a small portion of that money in a separate, global pot which can be paid out in case of cargo loss. Self-insurance is useful in that it is quick and efficient and doesn't require dealing with outside brokers, however it requires a great deal of internal control and analysis. Smaller agencies or agencies that have fluctuating size and types of activities may not be able to adequately predict their global self-insurance needs, and may end up facing substantial global losses.

A method of obtaining global blanket cargo insurance might come from soliciting large international insurance brokerages, who may be able to provide a flat or relatively fixed rate for cargo insurance based on their estimation of risk of any individual agencies' activities. Global cargo insurance might end up being slightly more expensive per kilogram, but saves substantial amount of time identifying insurance solutions for every transport. The specifics of a global insurance plan would be negotiated based on the need of the requester. As an example, if an aid agency maintains a large fleet of self-managed cargo vehicles in many high-risk countries, there may be a need to develop a high annual global premium to cover all risks associated with cargo movement. On the other hand, if an aid agency is largely only doing international transport using regular carriers, then insurance may be issued on a case by case basis.

## Incoterms

[International Commercial Terms \(Incoterms\)](#) used in international contracts of sale are widely agreed upon, pre-defined commercial terms for defining limits of risk, cost and liability for any form of international transport, detailing the roles and responsibilities of the shipper, the carrier and the receiver/consignee. Incoterms are negotiated and set by the [International Chamber of Commerce \(ICC\)](#), and are connected to various forms of international trade law and maritime time. Incoterms were established in the 1920s, and are now generally updated every ten years, with the most recent update in 2020.

Incoterms function as a short hand for all parties involved with an international shipment, and allow for different parties to quickly reference and understand where their obligations lie. The shipper in this context may be the supplier of goods, or it may be the party purchasing the goods and arranging for transport. The contracted carrier transporting the goods may only function as a broker or intermediary, but will be able to reference Incoterms when dealing with the shipper to fulfil its obligations. organisations that are planning international procurement and shipment should seek to include Incoterms in both their procurement and transportation contracts.

Incoterms cover all forms of international transport, however there are special inclusions for sea shipping only. the current reference point for shippers is Incoterms 2020, however sellers and carriers may agree on older versions of Incoterms insofar as all parties are aware of what terms they are referencing when talking about procurement and transport. A copy of the 2020 Incoterms chart can [be downloaded here](#).

## Incoterms 2020 for All Forms of Transport:



	Seller	Customs	Loading	Carriage	Named Place	Port	Vessel	Port	Named Place	Carriage	Customs	Unloading	Buyer
<b>EXW</b> Ex Works	Seller												Buyer
	Seller												Buyer
	Seller												Buyer
<b>FCA</b> Free Carrier			Seller										Buyer
			Seller										Buyer
			Seller										Buyer
<b>CPT</b> Carriage Paid To			Seller										Buyer
			Seller										Buyer
			Seller										Buyer
<b>CIP</b> Carriage Insurance Paid			Seller										Buyer
			Seller										Buyer
				Seller									Buyer
<b>DAP</b> Delivery At Place			Seller										Buyer
			Seller										Buyer
			Seller										Buyer
<b>DPU</b> Delivery at Place Unloaded			Seller									Buyer	Buyer
			Seller									Buyer	Buyer
			Seller									Buyer	Buyer
<b>DDP</b> Delivery Duty Paid			Seller										Buyer
			Seller										Buyer
			Seller										Buyer

Risk
  Cost
  Insurance

A general description of all-mode Incoterms:

**EXW**  
**Ex-Works**

Buyer takes possession of goods at the seller's premises or at another named place (i.e., works, factory, warehouse, etc.). The seller is not obligated to load the goods on any collecting vehicle, nor does it need to clear the goods for export (where such clearance is required).

**FCA**  
**Free Carrier**

Seller turns over possession of the goods to the carrier or another entity designated by the buyer at the seller's premises or another named place. The named place of transfer must be clearly identified; the risk passes to the buyer at that point.

**CPT**  
**Carriage Paid To**

Seller turns over possession of the goods to the carrier or another entity designated by the seller at an agreed place. The seller must contract for and pay the costs of carriage necessary to bring the goods to the agreed place of transfer.

**CIP**  
**Carriage and Insurance Paid To**

The seller turns over possession of goods to the carrier or another entity designated by the seller at an agreed place. The seller must contract for and pay the costs of carriage necessary to bring the goods to the agreed place of transfer. The seller contracts insurance cover against the buyer's risk of loss of or damage to the goods during the carriage. Under CIP the seller is required to obtain only minimum cover insurance. Should the buyer wish to have more insurance protection, it will need either to agree as much expressly with the seller or to make its own extra insurance arrangements.

**DAP**  
**Delivered at Place**

The seller transfers goods to the possession the buyer on the arriving means of transport (truck, vessel, aircraft) ready for unloading at the named place of destination. The seller bears all risks involved in bringing the goods to the named place, including insurance.

**DPU**  
**Delivered at Place Unloaded**

The seller transfers possessions of goods to the buyer, once unloaded, at a named place of destination. The seller bears all risks involved in bringing the goods to, and offloading them at the named place of destination, including insurance.

**DDP**  
**Delivered Duty Paid**

The seller delivers and transfers possession of the goods to the buyer, cleared for import on the arriving means of transport (truck, vessel, aircraft) ready for unloading at the named place of destination. The seller bears all the costs and risks involved in bringing the goods to the place of destination and has an obligation to clear the goods not only for export but also for import, to pay any duty for both export and import and to carry out all customs formalities.

**Incoterms for Seaborne Freight Only:**

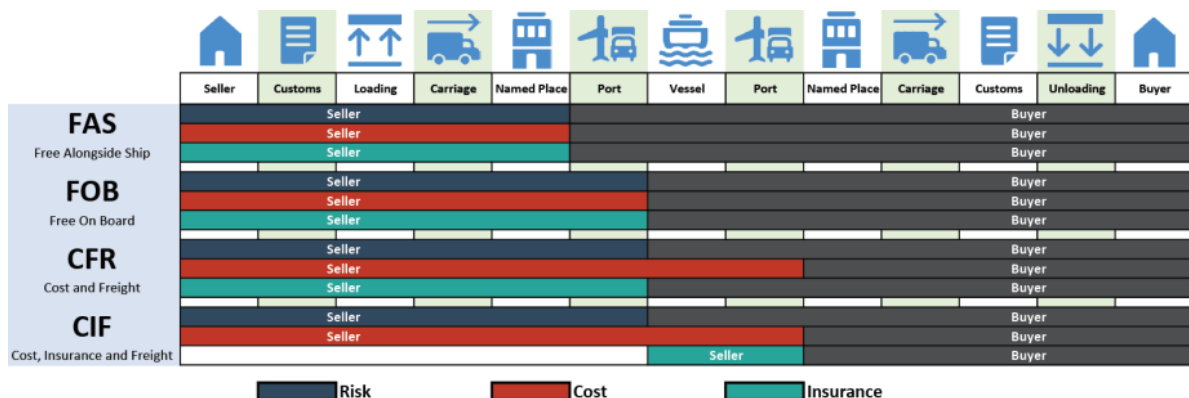

A general description of seaborne freight only Incoterms:

**FAS**  
**Free**  
**Alongside**  
**Ship**

The seller turns over possession when the goods are placed alongside the vessel (e.g., on a quay or a barge) nominated by the buyer at the named port of shipment. The risk of loss of or damage to the goods passes when the goods are alongside the ship, and the buyer bears all costs from that moment onward.

---

**FOB**  
**Free on**  
**Board**

The seller turns over possession of the goods on board the vessel nominated by the buyer at the named port of shipment. The risk of loss or damage to the goods passes when the goods are on board the vessel, and the buyer bears all costs from that moment onward, including insurance.

---

**CFR**  
**Cost and**  
**Freight**

The seller turns over possession of the goods on board the vessel. The risk of loss of or damage to the goods passes to the buyer when the goods are on board the vessel, however the seller must contract for and pay the costs and freight necessary to bring the goods to the named port of destination.

---

**CIF**  
**Cost,**  
**Insurance**  
**and**  
**Freight**

The seller turns over possession of the goods on board the vessel. The risk of loss of or damage to the goods passes to the buyer when the goods are on board the vessel. The seller must contract for and pay the costs and freight necessary to bring the goods to the named port of destination. The seller also contracts for insurance cover against the buyer's risk of loss of or damage to the goods during the carriage, however the seller is only required to obtain minimum cover insurance. Should the buyer wish to have more insurance protection, it will need either to agree as much expressly with the seller or to make its own extra insurance arrangements.

---

Title

Download - Incoterms 2020

File



## Packaging and Labeling

### Packaging

Shippers should be aware of several potential problems when packaging cargos for any form of transport:

- Breakage.
- Moisture.
- Pilferage.
- Excess weight.
- Spoilage/Expiration.
- Temperature sensitive items.

Any and all packaging should meet the needs of the shipped item, the recipient, the duration



of the transport, and the method of shipping. Packaging should:

- Meet shipping regulations.
- Ensure proper handling.
- Conceal the identity of the contents (where appropriate).
- Help receivers identify shipments.
- Insure compliance with environmental and safety standard.

Not only does the cargo need to be adequately packed but instructions be given to all parties handling the cargo at some stage of the venture to ensure safe delivery.

### **Packaging Types and Terms**

- **Outer Packing/Outer Packaging** - The outer most enclosure that contains or prevents unintended release of contents
- **Over-Packaging/Overpacking** - Items that are packaged in more than one layer or enclosure. Example: A box within a box, or multiple sacs within a larger carton. Over-packaging is common in handling of [dangerous goods](#).
- **Handling Unit** - The lowest unit at which cargo is handled, usually at the box or carton level.
- **Unit of Accounting** - the lowest level inventory unit that is tracked and accounted for.
- **Shipping Unit** - the lowest unit at which cargo is handled for shipping - may be the same as the handling unit, or may be accounted for at the pallet/Unit Load Device level.
- **Common Package Types**
  - Bale/Bundle
  - Carton/Box
  - Roll
  - Pallet
  - Set/Kit
  - Crate
  - Drum
  - Bag/Sack
  - Loose/Bulk/Individual Unit

## **Labelling**

Labelling for transport is an important consideration. Knowing that cargo is often broken down or shipped loose means that shippers must adequately mark cartons to facilitate tracking of cargo, especially for cargo transported by air. Insurance brokers also have the right to dishonour a claim of damage to goods, due to inadequate packing and marking for the selected mode of transport. It is strongly advised that all cargo intended for air transport be labelled at the level of the carton or handling unit, and should have some - if not all - of the corresponding data:

- Shipper.
- Logo of agency.
- Intended Destination.
- Items in package (if required)
- Packing List Number/Consignment Number.
- Weight and measurement of the package.
- Package contents (if appropriate to list externally without fear of pilferage).
- Numbered "Package 1 of X".
- Special handling requirements (temperature control, fragile, etc).

- [Dangerous goods](#) contained within.

Properly labelled packages will help reduce loss while in transit. Professional freight forwarding services tend to be extremely good at keeping large consignments together throughout the course of an air movement. Depending on the arrangement with the forwarder, large consignments can be split into multiple smaller shipments, and will be re-consolidated prior to delivery. In emergencies however, movement can be chaotic and cargo frequently delayed or lost. The more visible and easily identifiable relief cargo is, the more likely it is to reach its final destination.

[The International organisation of Standardisation \(ISO\)](#) has designed graphic symbols that are placed on packing units to instruct cargo handlers how to handle the cargo. These symbols are used worldwide and is a common language understood by all.

Any and all cargo containing dangerous goods being packaged for transport should be properly labelled according to the equivalent standard of the method of shipping. Information on proper labelling of dangerous goods of can be found in the [dangerous goods section of this guide](#).

## Air Transport

Air transport is by far the most time efficient mode of transporting goods, and in humanitarian contexts is used both domestically and internationally. Unfortunately, along with the speed and efficiency of air transport comes significantly higher costs and far more restrictions and complexities on handling of goods. In emergencies, and especially natural disasters and conflict situations where road access is difficult, air transport is often the preferred alternative.

## Common Terms in Air Transport

---

**Fixed wing**

The most common type of aircraft – any airborne vessel with wings that requires horizontal take-off and landing space.

---

**Rotor wing**

Helicopters of any configuration that have top mounted rotors to provide vertical lift, and have vertical take-off and landing capability.

---

**Civil Aviation  
Authority  
(CAA)**

Any authority that maintains legal jurisdiction over the airspace above any country. Aircraft operating within a country or flying over a country (overflight clearance) must make arrangements through CAAs, registering flight plans and obtaining proper clearances.

---

---

**International  
Aviation and  
Transportation  
Administration  
(IATA)**

An international governing body that sets safety regulations on commercial flight. Any aircraft commercially operating between two different countries that mutually recognise IATA standards is legally obliged to follow IATA regulations.

---

**International  
Civil Aviation  
Organisation  
(ICAO)**

A specialised UN agency that supports the development of mutually recognised civil aviation standards among UN member states, including air safety regulations.

---

**Tech Stop**

Used to describe a situation when an aircraft must be on the ground for technical reasons. Usually tech stops refer to refuelling, but they can also be for unscheduled maintenance. Sometimes referred to as “going technical.”

---

**Domicile**

Where the “permanent” home of the aircraft is, usually where the aircraft is originally licensed, and near the owner and operator. Domicile location are also frequently where aircraft receive routine maintenance as well, but not always.

---

**Repositioning**

Moving an aircraft from one location to another location in anticipation of another future need.

---

**Ground  
Support  
Equipment  
(GSE)**

Any equipment involving the offloading or moving of cargo around an airport or landing strip, in lead up to loading or offloading cargo and people. GSE also includes catering, refuelling and power supply units. Ground handling crews can be employees of governments, or sub contracted service providers.

---

**Airside**

Any part of an airport beyond a secure checkpoint usually associated with loading/offloading, service operations and take off/landing. Airside operations occur within close proximity to working aircraft.

---

**Cube/Weigh  
Out**

The act of reaching the maximum limitations to a specific airframe, either by reaching its maximum volume (cube out) or its maximum weight (weigh out).

---

<b>Flight Hours</b>	Defined as the specified hours aircraft, pilot or crew are allowed to operate for. Physical aircraft may only be able to operate for a maximum number of hours in any week or month period, while pilots and crew can only operate for a maximum number of hours per day/week before mandated "crew rest."
<b>Loading</b>	All the special considerations surrounding aircraft loading, such as loading specifications and safety concerns. Loading is overseen by a "Loadmaster" or other trained crew, who will ensure proper distribution of weight and balance of cargo, while also screening for prohibited or controlled items.
<b><u>Dangerous Goods (DG)</u></b>	Any cargo that might pose a threat to aircraft while in transit or loading/offloading. DG is universal to all forms of transport, but is especially important to air aviation. Definitions, handling and labelling standards for DG are outlined in the IATA <a href="#">Dangerous Goods Regulation (DGR)</a> .
<b>Sling Loading</b>	The act of transporting cargo on the outside of a rotor wing aircraft using a net or cable of some kind, with cargo hanging below the aircraft. Sling loading requires special equipment and specially trained pilot and crew, and can only be used in some ideal circumstances.

## Air Transport Arrangements

The nature and type of the arrangements humanitarian agencies enter into for the movement of cargo by air will be largely informed by the volume of goods, type of goods and shipping/destination points. Most medium sized cargo loads (1-20 full pallets / 30 cubic meters) shipped internationally will generally not require a specialised flight, while a high volume of cargo (500+ full pallets / 700 cubic meters) might require obtaining a full plane. Conversely, extended, routine operation inside the borders of a country no matter how small might require long term leasing of an aircraft. For a general overview of airframe size relative to cargo capacity, reference the [air cargo capacity table](#).

In almost all situations, different arrangements for air cargo transport will need to be arranged by forwarders, brokers, or other third-parties who have the ability to connect requestors to various available options. Regular movement of small cargo can be done through a typical freight forwarder, while specialised charters or leases may be done through specialised brokerages. Agencies acquiring these arrangements will need to go through their typical procurement process.

Typical air transport arrangements can look like:

**Regular scheduled** – Air carriers around the world develop regular routes between high volume or common destinations. Cargo travelling on regularly scheduled movement is similar to buying a seat on a regular passenger plane – it's easy to identify space and move cargo because the movement is predictable and frequent. Cargo shipped along regularly scheduled routes can be moved as excess cargo in the hold of a commercial passenger plane, or transported using regularly scheduled cargo planes. Often, cargo moved along regularly scheduled routes will be broken up into multiple tranches and re-consolidated on the receiving end, a process that is enabled by the predictability of arriving flights. Regular movement by air is cheaper than organising special flights. Unfortunately, regular scheduled flights will not deviate from their courses, and tend to only serve more developed markets.

**Charters** – Many forwarders and air carrier specialise in organising charter flights – flights specifically dedicated to the movement of one or a very few consignments. Charter flights are often extremely expensive, but have the advantage of being able to depart from a specified origin, arrive at a specified destination, and meet the size and airframe requirements of the proposed air movement. A properly arranged charter might be able to match the size of the aircraft to the requested cargo size saving on total costs, as well as identify special needs such as the overall operating environment or limitations on size of aircraft. Unfortunately, charting aircraft frequently means repositioning an aircraft from another area as the exact airframe may not be domiciled at the desired point of departure. This means that users of charter services usually have to pay for repositioning costs. As charters are basically only single aircraft, shippers run the risk of technical defaults holding up the entire process as well. Factors that influence the decision to charter and the nature of the aircraft chartered:

**Aircraft Leasing** – In situations where long term, well identified needs are in place, organisations may choose to lease aircraft. Aircraft can be leased for months or years at a time, and leased aircraft can be used on an ongoing basis for needs as they evolve. A “Dry Lease” is when an aircraft is made available to an agency without additional support of crew or maintenance, while a “Wet Lease” is a lease type that includes pilots, crew, and aircraft maintenance. Wet leases are more expensive, especially because flight and maintenance crews are paid at a commercial rate and because food and housing is usually part of the contact, but many agencies prefer wet leases due to the fact they take the complexity of aircraft management out of the hands of non-aviation experts.

**Other arrangements** – During times of emergency, air cargo may be transported through a variety ad-hoc or irregular means. This might include cargo movement on military air craft, in personally owned air craft, or agencies offering free space to each other. The process of utilising non-traditional air transport to move cargo can have varied procedures and tolerance thresholds. Irrespective of the movement type, users will have to respect CAA and national import regulations at all times.

## **Unique Components to Air Transport**

Air transport has become so common in the modern world that shippers frequently take key important factors for granted, or overlook them when planning and utilizing aviation for cargo. Understanding some of these unique needs will help when planning large international shipments, but will also help understanding in-country and response specific aviation needs as well.

## **Weight as a Limiting Factor**

In all aviation, one of the largest factors that impact speed and price is the overall weight of the airframe and its contents. In cargo operations, the take-off weight of an airframe in flight can vary substantially – an airframe fully loaded with heavy cargo easily double the total weight of the same aircraft without cargo. All aircraft have what is known as a “maximum take-off weight” – or the maximum weight at which an aircraft can safely take off and reach the desired altitude and flight path. This weight is calculated as a combination of the physical aircraft, cargo, passengers, and fuel. The maximum take-off weight can also be impacted by outside conditions, such as the wind direction, ambient temperature or the length of a landing strip. Pilots and loadmasters have ultimate discretion for the safety of their aircraft and crew, and will make the final calculations on what is safe and achievable for an aircraft, and what is not.

Based on the aforementioned factors, the acceptable weight of the payload may fluctuate, changing costs and overall delivery schedules. For this reason, light but voluminous cargo might always be able to fill up an entire cargo hold – or “cube out” by reaching the maximum available load through volume – while more dense and bulky cargo might be able to take a relatively small portion of a cargo hold – or “weighing out” by reaching the maximum lift weight. The orientation of a cargo inside of an aircraft is also very important, and loadmasters and crews will need to properly place and balance loads to maximise aircraft safety while taking off, flying and landing.

## **Fuel as a Limiting Factor**

Aircrafts consume relatively large amounts of fuel per kg compared to other transport methods, and unlike other modes of transport, stopping to undergo refuelling is a complicated process. Whereas a boat or vehicle running out of fuel in mid-movement might strand a vehicle or leave it adrift, an aircraft running out of fuel has immediate and tragic consequences. In aviation, fuel calculations are estimated per flight, based on range, altitude, cargo load, wind conditions, and if the airport of arrival has refuelling capabilities. In real terms, there are many factors that might make travel over the same distance consume more or less fuel than it would in a similar route. An increase in the take-off and carriage weight increases fuel used per km, while flying into a prevailing wind-current will also increase fuel consumed per km. Knowing this, crews will increase the fuel in their tanks, which might adversely affect maximum take-off weight. In other words, the cost for kg of cargo might go up, while the total quantity of kg you can ship might go down.

## **Prevailing Conditions as a Limiting Factor**

Aircraft – though highly engineered pieces of equipment – can still be heavily impacted by the physical environment. In addition to factors that can be controlled by the crew and pilots (such as load and maintenance) some external factors that might impact an aircraft’s ability to operate safely are:

- Take-off/landing altitude – the higher altitude a landing strip or airport is, the more hazardous take-off and landing might be. Fixed wing aircraft will need to approach landing strips at faster speed and reach a faster speed to take off, all while requiring a longer runway to accommodate both. Rotor wing aircraft will need a slightly higher rotational speed to achieve lift at higher altitudes as well.
- Wind – heavy winds can make take-off/landing and flight hazardous. For fixed wing aircraft, a strong tail wind might increase the distance for safe take off, which is why many airports will reverse the landing and take-off directions if the direction of the winds change. A sidewind blows at a perpendicular angle to the direction of movement of an aircraft in flight, takeoff and landing, and can make navigation and take-off/landing dangerous. Any strong prevailing wind can make operating a rotor wing aircraft of any kind dangerous, especially gusts that may tilt rotors during take-off/landing or cause sudden loss of altitude.
- Atmospheric conditions – Dust, fog, and heavy rain can render flight and take-off/landing difficult or impossible, especially in night time settings. Air temperature also plays major factor; excessive outside heat can make taking off difficult, and aircraft may be not be able to take off in extreme heat.

## **Airport Facilities as a Limiting Factor**

Though aircraft may be able to physically fly to a destination, they may not be able to adequately service the cargo needs. Limiting factors might include:

- Lack of refuelling capability on the ground – aircraft on long haul flights may not be able to properly stop and offload if they cannot refuel.
- Lack of ground handling equipment – most commercial aircraft will require some form of specialised MHE to offload and move cargo around. Lack of proper MHE can impede or prevent offloading or loading all together. Some aircraft, especially military aircraft have the capacity to load without MHE, and may have onboard ramps to tail and nose load aircraft by hand.
- Lack of customs capability – not all airports have the ability to clear cargo through customs, limiting movement to domestic flights only.
- Lack of ground service/ground handling – ground crews help load/offload, service and conduct repairs to aircraft. Without ground crews, small technical issues may ground aircraft until proper technicians can arrive. Ground services also conduct de-icing, support catering, and provide other support services that can impact timely departures.
- Lack of storage and holding capacity – airports that lack proper ability to store cargo once offloaded may quickly become unusable for aircraft operations. Cargo building up on the apron space of the tarmac might impede the flow of ground movement and even prevent further cargo from being offloaded.
- Lack of aircraft parking space – an airport may lack the space for multiple aircraft to land, park and offload at the same time. Landing strips or airports limited to one or a small number of aircraft that can park at the same time will need to schedule flights accordingly, impacting delivery schedules
- Lack of communications equipment – immediately after disasters, surface to air communication, radar equipment or even observation towers may be damaged, which impede safe approach, landing and take-off of aircraft.



## **Regulations as a Limiting Factor**

Local and internationally recognised regulations may impede cargo operations by limiting or preventing aircraft from operating all together. Some of these regulatory factors might include:

- Overflight clearance – aircraft must obtain overflight clearance from relevant in-country CAAs to operate in any country specific airspace. Countries may have bans on specific airlines or aircraft from registered in certain countries. Overflight clearances may also be delayed or rejected based on political or security concerns.
- Landing permits – like overflight, aircraft must obtain permission to land at an airport through both the CAA and airport authorities. Restrictions might include airframe type, origin or intended purpose. Aircraft may also be limited by the already in place schedule.
- Noise restrictions – airports near urban centres may ban certain large body aircraft that have excessively loud engines. Many of the larger high lift capacity cargo aircraft also happen to be very noisy, which might impact what airports cargo can fly out of.
- Maintenance Schedules – many air craft will require annual maintenance that might take them off line for up to a month, depending on the aircraft and the location an aircraft might need to be serviced at. This will impact the availability of leased aircraft for regular activities.
- Flight-hours – both aircraft and the crews have a maximum number of flight hours they can operate at any given time. Aircraft may be restricted to the number of hours they can fly in a week or month, while crew – and especially pilots – are restricted to the number of hours they can operate in any given 24 hour period, accompanied by what is called mandatory “crew rest” hours.
- Pilot Rating – in addition to being fully licensed to operate an aircraft, pilots also must be rated for key airports or conditions. In some contexts, pilots may need to undergo additional training or simulation time to fully reach this rating, possibly impacting ad-hoc delivery of emergency goods.

## Aircraft Registration

Aircraft operating in any domestic airspace, or above any controlled territory of a country should be legally registered to operate. The registration process varies from country to country, and there are different types of registration depending on the intended use of the aircraft, such as military or non-international. As a general rule, most countries:

- Won't allow an aircraft to be registered twice, even in another country.
- Require that registration numbers (sometimes referred to as a tail numbers) be printed on a fireproof plate on the fuselage.
- Require aircraft be registered in the country in which the carrier is based or domiciled.

If an aircraft will operate internationally – fly between/over two or more different sovereign countries – it must also have declared an intent to operate internationally through its local CAA and comply with international standards including IATA and ICAO requirements for marking, communications equipment, and safety standards. If an aircraft operates internationally, it is considered a “flag-carrying” vessel of its originally country of registration, however while in the airspace of another country it must comply with all local laws and regulations. Without declarations of intent to operate internationally and without fully compliance with international standards, aircraft may not be allowed to register a flight plan, land or load/offload passengers or cargo, or even receive technical assistance when operating in a country outside of where the aircraft is registered.

Example Tail Numbers:



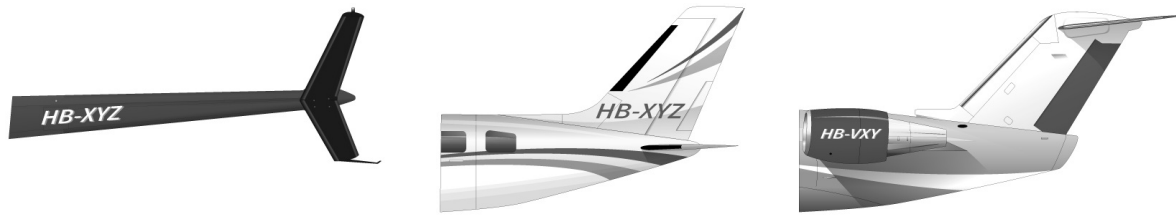

## Airport / Airfield Operations

Large commercial airports can be busy places, and access is usually highly restrictive and controlled. Humanitarian actors won't usually get direct access to airside operations of a major airport, but from time to time humanitarian personnel will need to gain access to and facilitate cargo alongside the aircraft. In less developed or more rural field settings, it's quite common that humanitarian actors will need to operate on or around landing strips.

### Commercial Airports:

Activities in and around commercial airports tend to be highly regulated for a variety of reasons; aviation equipment is expensive and highly sensitive, customs operations may necessitate access control, and airports are considered key infrastructure choke points.

Commercial airports may have a relatively high volume of throughput, with aircraft taking off, landing and exchanging goods and passengers frequently. The immediate airspace surrounding airports is highly restricted, and only aircraft who have registered a flight plan or communicated well in advance are typically allowed to land. Air-traffic is controlled through a control tower, that typically has line-of-sight, radar and radio communication capabilities for arriving and departing aircraft. Aircraft follow a flight path on approach or take off, meaning there is a very specific route aircraft can travel long while moving around the airspace above an airport. Flight paths reduce the chances of mid-air collisions and near misses, and even helicopters and other vertical take-off aircraft are expected to follow the flight path around airports.

Controlling the flow of aircraft is vital for a functioning airport. There is a limited number of landing strips, and a limited amount of space on the ground for planes to taxi and park. Too many aircraft taking off, landing or operating on the ground can cause accidents and serious damage. It's difficult for airplanes to manoeuvre quickly while on the ground, and planes landing or taking off may collide with planes moving around a runway. Additionally, too many aircraft on the ground may lead to planes touching wings or colliding with each other, which can damage and ground an aircraft.

Large airports should have the ability to service large aircraft and manage cargo operations. Large commercial or long haul aircraft typically won't carry enough fuel for a return journey and will need refuelling upon arrival. Many large commercial aircraft also frequently require an external electrical power source to start the engine ignition process, usually referred to as a Ground Power Unit (GPU). Without fuel or a GPU, many aircraft simply cannot land in an airport even if they are physically capable of doing so - there would be no way for them to safely start their engine or take off again.

**Ground Power Unit (GPU)**

**Airside Refuelling Truck**



---

Large commercial airports will also have other services available for aircraft and crews. Service technicians and spare equipment may be kept on site for commonly used aircraft, especially if the airport is a hub for a commercial airline with a pre defined fleet. Commercial airports are also likely to have rapid response emergency crews, including emergency medical technicians and fire suppression systems such as fire trucks.

In rapid onset emergencies, the break down in communications equipment or airport amenities can lead to airports ceasing to function for days or weeks at a time, which can severely impact response activities.

Cargo operations in commercial airports are heavily aided by ground handling teams and specialised MHE. Many large wide-bodied commercial aircraft are specifically engineered for efficient high altitude long-haul flights; this unfortunately results in aircraft bodies that are not optimised for loading or unloading. The majority of aircraft used for commercial cargo will have significant ground clearance, requiring what is called a high loader / k-loader / scissor lift, container pallet transporters, dolly's or other specialised equipment.

Example Ground Handling Equipment:

**High-Loader / K-Loader / Scissor Lift** -Used to lift pre-made ULDs and pallets directly to the side of large commercial aircraft. High-loaders are adjustable and can move under their own power. The flat deck of a high loader also has powered rollers that can mechanically slide cargo on to the aircraft through the appropriate opening.



**ULD / Aircraft Pallet Mover** -A specialised vehicle designed to move around the oversized ULDs and aircraft pallets on a tarmac or landing strips. The pallet movers have rollers and other equipment to quickly get cargo items on and off, and work in conjuncture with high-lights and other MHE.



**Belt Loader** - An automated conveyor belt with adjustable height that can convey smaller items to the door of any sized airframe. Belt loaders are usually used for luggage, loose packages or small specially items. Belt loaders may also be used for aircraft that is too small to accept a high-lift.



**ULD / Airplane Pallet Pull Cart** -A pull cart designed to carry ULDs and pre-built airplane pallets. The pull carts are not powered by themselves, and must be pulled or pushed across the tarmac. Rollers assist offloading and loading, but cargo must be physically pushed as there is

no mechanically driven process.



Access to the planes may be through relatively small cargo doors on the side or nose of the aircraft, though tail loading aircraft do operate out of commercial airports as well.



K-loader - Cargo requiring high lift loading alongside an aircraft

Once cargo is on the ground, it is moved around and handled by ground handling agents. If the airport has customs capabilities, there will typically be an adjacent bonded storage facility of some kind where cargo is held until it is cleared. The overall movement of cargo around an airport is highly controlled and usually quite efficient. As such, cargo operations are usually only carried out by contracted or subcontracted teams of professionals.

### **Airfields / Landing Strips:**

In humanitarian contexts, operating small to medium sized aircraft inside specifically to aid the movement of cargo within of the area of response are quite common. In some instances, small chartered craft can be used for one or a few individual flights, while other contexts there can be specifically planned "hub and spoke" models for humanitarian air cargo operations, with smaller aircraft delivering throughout a responses from a larger central airport. In the majority of contexts, smaller air fields are entirely for domestic use. Customs is usually never going to be processed at the remote airfield or landing strip level - usually cargo offloading points in remote locations are the final leg of an in-country hub and spoke distribution system.

Remote field locations and small airfields probably will not have most, if any, of the amenities of a larger commercial airport. Aircraft operating around smaller field landing strips should have considered the following:

- Adequate surface to ground communications equipment on a usable operating band accessible by both the pilot and ground actors.
- Fuel for the return flight.
- An onboard power supply to start engines.
- Basic equipment for repairs.

Ideally, there will be an identified safety officer or team on the ground, who can ensure that the landing strip is free of debris, animals or people, and who should have the capacity to coordinate with any potential incoming aircraft regarding scheduling and landing conditions. Some landing strips may be impacted by bad weather, making safe taxi and takeoff impossible. At all times, aircraft operating in or around remote landing strips must still obey local CAA regulations, and may even need to coordinate with local military and local community leaders to avoid incidents.

Aircraft will have to be appropriate for the operating conditions, and the underdeveloped nature of many landing strips in humanitarian contexts tends to limit the size of most cargo aircraft. Aircraft will need to be able to safely take off and reach altitude based on the length of the landing strip, the anticipated cargo weight, and the outside weather conditions. Rotor wing aircraft will need to account for any potential negative side effects of their rotor down-draft while on approach, avoiding damaging homes or property, injuring humans or animals with debris, or making the landing site dangerous for other aircraft.

Cargo operations in small airfields or landing strips should match the available capacity on the ground. Most cargo at remote landing strips will need to be loose loaded and offloaded by hand. The aircraft themselves will need to be capable of being safely accessed and loaded/offloaded by relatively unskilled labour, usually with ramps or low side clearance.

Cargo offloaded using ramps - can be done easily by hand

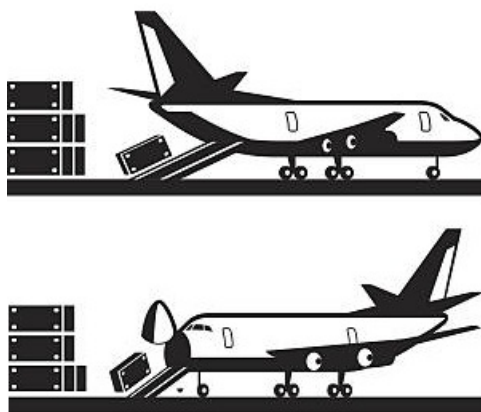

Cargo requiring special ground equipment and MHE to offload

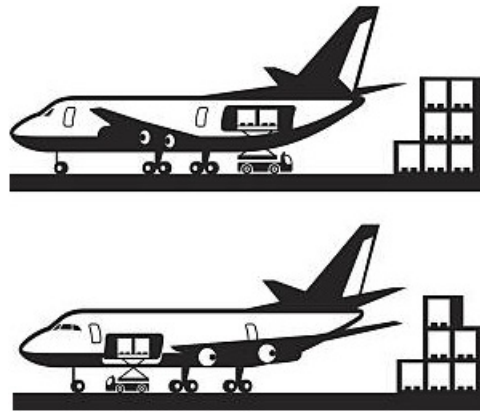

Physical access to landing strips may be quite unrestricted, meaning persons and vehicles may be able to operate right next to the aircraft. Any vehicles brought to the landing strip to facilitate cargo movement should be careful not to get near or damage the aircraft; an aircraft grounded in a remote location likely will not have access to special parts or sophisticated repairs for some time, effectively putting the aircraft out of service.

## Personal Safety Around Aircraft

Operating on landing strips or airports can be extremely dangerous. Aircraft have extremely powerful propellers or jets, while vehicles and MHE may move chaotically around busy tarmacs. The necessity to utilize certain types of personal protective equipment (PPE) depends on the nature and size of the operation. Common PPE used around cargo aircraft might include:

- High-visibility / reflective vests

- Work gloves and close toed shoes
- Ear and eye protection

Reflective vests should always be used in airside operations where motorized ground handling equipment is used, or where multiple aircraft may be taking off/landing/taxing simultaneously. Aircraft and ground handling equipment often have very poor visibility, and their size and weight can easily harm or kill humans.

Aircraft propulsion can also be extremely loud, and operating within any close proximity to an aircraft with jets or propellers turned on can easily permanently damage hearing. Hearing damage may be acute and rapid, or it may accumulate over time. Ground crew operating around active aircraft at any time should wear proper ear protection at all times. Any person travelling in a helicopter for any period of time should also always wear ear protection. Some older fixed wing aircraft also may require passengers to wear ear protection.

Aircraft have powerful propulsion systems to keep them in flight, and these propulsion systems are extremely dangerous to be around when the vehicle is not in flight. When moving around a landing strip or airport tarmac, **never under any circumstances** approach a jet turbine, helicopter blade or propeller while it is in motion, unless it is under the direct supervision of qualified ground safety personnel. Turbines, blades and propellers should also be avoided if the aircraft engine is running or the operating status of the aircraft is unknown.

When operating around an airfield, never assume freedom of movement. Airfields and airports are often highly restricted environments, and air and ground handling crews won't necessarily expect the presence unauthorized persons. Before operating in any space where aircraft land, take off, or are repaired, refueled or loaded/offloaded, consult with airport authorities and your local security focal point.

## **Sending Goods by Air**

### **Air Transport Documentation**

The overall requirements for and types of documentation used for air transport depend on the nature of the air transport. The normal documentation requirements for most shipments ([waybill](#), [packing list](#), [proforma](#), etc) applies to all shipments, including air shipments. There are documents specific to air shipping however. These might include:

**Airway Bills (AWB)** - By far the most common and important document related to airfreight. AWBs are regulated by IATA, and have a standard format for ease of reading and reference. It should be noted that AWBs are only legally required for international transport, however domestic CAA and even non officially regulated air carriers can and do request the use of AWBs. The AWB is the carrier's receipt by air, evidence of the contract of carriage and is usually non-negotiable. It is made out to a named consignee who is the only party to whom the carrier can deliver. Many carriers even make it easy to track and trace cargo in real time using AWB numbers on their website. Through its standardised layout, AWBs will denote:

- Shipper name and contact details
- Consignee/Notify party name and contact details
- Special handling information
- Cargo description, including item description and total chargeable weight
- Customs value

The above information should match the information coming on other shipper generated

shipping documents. In the top right corner of every official AWB, there will be an AWB number, which is unique to that one AWB. The AWB number is always eleven digits; the first three are the IATA designated airline prefix, while the last seven digits are the unique serial number. Many airlines make AWB numbers easy to trace online.

Original, airline generated AWBs are generally the only acceptable AWBs that customs authorities will recognise. The original paper copy will go with the consignment, but scanned copies are usually acceptable for customs purposes. The AWB generated by the airline is typically referred to as the "Master" AWB, or sometimes MAWB.

Shipper's Name and Address		Shipper's account Number		Not negotiable <b>Air Waybill</b> issued by	
Consignee's Name and Address		Consignee's account Number		Copies 1, 2 and 3 of this Air Waybill are originals and have the same validity	
Issuing Carrier's Agent Name and City		It is agreed that the goods described herein are accepted in apparent good order and condition (except as noted) for carriage SUBJECT TO THE CONDITIONS OF CONTRACT ON THE REVERSE HEREOF. ALL GOODS MAY BE CARRIED BY ANY OTHER MEANS INCLUDING ROAD OR ANY OTHER CARRIER UNLESS SPECIFIC CONTRARY INSTRUCTIONS ARE GIVEN HEREON BY THE SHIPPER, AND SHIPPER AGREES THAT THE SHIPMENT MAY BE CARRIED VIA INTERMEDIATE STOPPING PLACES WHICH THE CARRIER DEEMS APPROPRIATE. THE SHIPPER'S ATTENTION IS DRAWN TO THE NOTICE CONCERNING CARRIER'S LIMITATION OF LIABILITY. Shipper may increase such limitation of liability by declaring a higher value for carriage and paying a supplemental charge if required.			
Agent's IATA Code		Account No.		Accounting Information	
Airport of Departure (Addr. of first Carrier) and requested Routing		Reference Number		Optional Shipping Information	
to	By first Carrier	Routing and Destination	to	by	to
				Currency	Declared Value for Carriage
				Declared Value for Customs	
Airport of Destination		Flight/Date	For Carrier Use only	Flight/Date	Amount of Insurance
Handling Information		INSURANCE - If carrier offers insurance, and such insurance is requested in accordance with the conditions thereof, indicate amount to be insured in figures in box marked 'amount of insurance'			
		SCI			
No. of Pieces RCP	Gross Weight	kg/lb	Rate Class (Commodity Item No.)	Chargeable Weight	Rate / Charge
					Total
					Nature and Quantity of Goods (incl. Dimensions or Volume)
Prepaid		Weight Charge	Collect	Other Charges	
		Valuation Charge			
		Tax			
		Total other Charges Due Agent			
		Total other Charges Due Carrier			
Total prepaid		Total collect	Signature of Shipper or his Agent		
Currency Conversion Rates		cc charges in Dest. Currency	Executed on (Date) at (Place) Signature of issuing Carrier or its Agent		
For Carrier's Use only at Destination		Charges at Destination	Total collect Charges		

**House AWB** - A "House" AWB - sometimes referred to as a HAWB - is generated by a forwarder

or broker and provided to a client upon request. HAWBs generally have all the same information as a regular AWB, but are not necessarily signed or have the same tracking information as the MAWB. Customs authorities generally do not recognise HAWBs as an official document for customs procedures as there may be some difference between the HAWB and the MAWB. HAWB may still be useful for internal tracking purposes, however.

**Non-Standard Waybills** – In emergency settings, especially when in-country movement is required via air, the AWB may not be applicable or available. Cargo moved via unconventional air movement will generally always require some form of documentation, however this may look like a stand-alone packing list, self-made cargo manifest (similar to a packing list), or in the case of movement on military assets, a standard form internal to that specific military.

**Shippers Declaration of Hazardous Goods (HazDec)** – Much like AWBs, HazDecs are predefined by IATA, and are essential to the shipping process. HazDecs contain relevant information on any and all DG items for loadmasters and pilots. Any airline following IATA regulations will not accept a completed HazDec unless it was filled out and signed by someone who is fully certified in DG handling through an IATA accredited program. Failure to comply with proper completion of a HazDec, or incidents that may occur from incorrectly documented DG can result in fines, court action and jail time. Please consult the [Dangerous Goods section to this guide](#) for more detailed information.



SHIPPER'S DECLARATION FOR DANGEROUS GOODS



Shipper		Air Waybill No.						
		Page      of      Pages						
		Shipper's Reference No. (optional)						
Consignee								
Two completed and signed copies of this Declaration must be handed to the operator.		<b>WARNING</b>						
<p><b>TRANSPORT DETAILS</b></p> <p>This shipment is within the limitations prescribed for:</p> <p>(delete non-applicable)</p> <table border="1"> <tr> <td>PASSENGER AND CARGO AIRCRAFT</td> <td>CARGO AIRCRAFT ONLY</td> </tr> </table>		PASSENGER AND CARGO AIRCRAFT	CARGO AIRCRAFT ONLY	Airport of Departure (optional):		Failure to comply in all respects with the applicable Dangerous Goods Regulations may be in breach of the applicable law, subject to legal penalties.		
PASSENGER AND CARGO AIRCRAFT	CARGO AIRCRAFT ONLY							
Airport of Destination (optional):								
				Shipment type: (delete non-applicable)				
				<input type="checkbox"/> NON-RADIOACTIVE <input type="checkbox"/> RADIOACTIVE				
<b>NATURE AND QUANTITY OF DANGEROUS GOODS</b>								
<b>Dangerous Goods Identification</b>								
UN or ID No.	Proper Shipping Name	Class or Division (subsidiary hazard)	Packing Group	Quantity and Type of Packing	Packing Inst.	Authorization		
Additional Handling Information								
I hereby declare that the contents of this consignment are fully and accurately described above by the proper shipping name, and are classified, packaged, marked and labelled/placarded, and are in all respects in proper condition for transport according to applicable international and national governmental regulations. I declare that all of the applicable air transport requirements have been met.				Name of Signatory  Date  Signature (See warning above)				

## Chargeable Weight

When procuring air transport services, planners must contend with what is called "chargeable weight". As a general rule, airlines charge customers per the gross weight of their cargo. Due to the nature of air travel, an increase in weight generally means an increase in fuel, which is an increase in cost. However, some shipments by their nature are extremely light even though they may take up a large volume. Even though light cargo may take up less fuel, airlines must still charge some basic minimum to recover their operating costs as charting per weight would actually lose them money.

To address income loss to non dense cargo, air operators may speak in terms of "volumetric weight" or "cubic weight." Volumetric weight is a method of determining how to evaluate the relative costs of transporting items based on their volumes. Volumetric weight can be calculated using the following equations:

**Metric**

$$(L \text{ (cm)} \times W \text{ (cm)} \times H \text{ (cm)}) / 6,000 = \text{Volumetric Weight (KG)}$$

**Imperial**

$$(L \text{ (in)} \times W \text{ (in)} \times H \text{ (in)}) / 166 = \text{Volumetric Weight (LB)}$$

**Imperial to Metric**

$$(L \text{ (in)} \times W \text{ (in)} \times H \text{ (in)}) / 366 = \text{Volumetric Weight (KG)}$$

Chargeable weight then refers to the "relative" weight an airline will bill customers at. As a general rule, the transporter will quote customers which ever the greater cost between the two weight values is - the actual gross weight of the cargo or the volumetric weight of the cargo. The airline will be the ultimate party determining how to charge customers, but users of air service should pay close attention to the resulting "chargeable weight" contained on their AWBs. There may be situations where the chargeable weight is significantly higher than their gross weight, which can impact budget and planning.

No. Of Pieces RCP	Gross Weight	kg lb	Rate Class		Chargeable Weight	Rate	Charge	Total
			Commodity Item No.					
1	460.0	K	Q		460.0			As Agreed

## Movement Timing

In the world of aviation, timing is an enormous factor. Aircraft operating out of commercial airports must adhere to strict schedules and time tables.

- Regularly scheduled air craft typically have pre-defined routing that means they will land and take off at specific intervals that will not change much.
- Charter aircraft are frequently being bid upon by multiple parties, and unless a contract is signed they cannot commit for long periods of time.
- All aircraft are subject to the time tables of the airport they operate in. Large commercial airports might limit the amount of time aircraft can spend on the ground before accruing additional charges. Aircraft will typically only be allotted a limited time in specific parking spots as well.

When arranging to ship cargo by air, parties should be prepared well in advance and have all cargo ready at exactly the time specified by the forwarder or the air operator. A failure to deliver cargo on time could result in additional charges, or losing space on the aircraft all together.

## **Local Aircraft Contracting**

In austere operating environments, individual response agencies may require the use of ad-hoc cargo movement using local air operators. Identifying and understanding the proper aircraft or proper service provider can be extremely challenging, especially at local levels operating with limited time and budgets.

Locally operated aircraft in emergency or conflict settings pose unique and enhanced risks to parties who may wish to contract the service:

- Local/small aircraft may not be fully registered to operate in the context of operation.
- Local operators may have insufficient safety standards, or a known history of safety and security incidents humanitarian agencies may not know.
- In conflict settings, local air operators may be involved with transportation of weapons or supplies to parties of the conflict, sometimes along the same route humanitarian organisations operate.
- In any context, local operators may be involved with smuggling, human rights violations, or other illegal or unethical activities.

As a general rule, humanitarian agencies should not charter local aircraft directly with owners of aircraft. Instead, small scale or local charter aircraft should still be solicited through a reputable and known freight forwarder or brokerage service. Though going through a third-party may add some additional costs, forwarders and brokers have access to information or tools that enable them to screen for inappropriate or unethical transporters. The contracted payment terms and arbitration processes will also likely be more transparent and well defined when going through a reputable third-party.

In the event a third-party forwarder or brokerage is not available or not able to sufficiently fulfil the charter needs, and a humanitarian agency still wishes to solicit local air transport, there are a few steps to be considered by contracting agencies:

- Obtain aircraft registration/tail number, and names of pilot and crew. Though a forwarder may not be able to contract with the party, they may still be able to do a due diligence check.
- Ask other agencies who used the service in the past, as well as consult with local UN offices who may track aircraft (ICAO, UN agencies contracting air assets in country, etc).
- If possible, contact local Civil Aviation Authorities to both check registration and obtain information on safety history.
- Search for the registration/tail number online to see if the aircraft has been flagged for any reason.
- Ensure the air operator understands the route, locations, and cargo (type, dimensions).
- Never sign a contract unless it has been reviewed by both a lawyer locally, and by a designated legal focal point in headquarters.
- Payment terms should indicate payment is only due on successful delivery of cargo – never accept terms that include payment even if aircraft is unable to perform its contracted duties for whatever reason.

## **Cargo Configuration for Air Shipping**

### **Aircraft Loading and Stowage**

Cargo shipped via air tends to require more attention to details. Unlike the inside of a standard

shipping container or regular box truck, the inside of aircraft tends to be irregularly shaped. Fixed wing aircraft – especially fixed wing aircraft that operate at high altitude – will have curved cylindrical interiors, while larger aircraft may have multiple decks of varying heights. Additionally, the width and height of interior cargo holds and aircraft doors is different for virtually every aircraft. Frequently, more than one aircraft will be used for multiple legs of a transport route, meaning pallets can be broken down and cargo reloaded multiple times to match the different types of aircraft. This tends to lead to cargo being broken down and re-consolidated extensively throughout the transport process.

While loading and storing cargo onto an aircraft, there are some specific physical limitations to what and how items can be loaded:

**Cargo Hold** - The cargo hold - or sometimes just referred to as a "hold" - is any space on an aircraft where cargo is stored and transported, including any of compartments on an aircraft. Holds of each aircraft have specific dimensions, including height, depth, width, and shaped curvature of the airframe itself. These dimensions will limit what and how objects are loaded.

**Payload** - the maximum carrying capacity of an aircraft, usually expressed in weight. Max payloads may change for a single aircraft based on distance and operating conditions.

**Door Dimensions** - Doors are any/all points where cargo can enter or leave an aircraft. Door dimensions have maximum sizes specific to the aircraft, and ultimately limit what can be loaded. Even the hold is large enough to store a certain object, it may not be able to fit through the doors of the aircraft. Planners and loaders should understand this before trying to load an aircraft.

**Load Balance** - Cargo loaded onto a plane must be properly balanced. A balanced cargo load maximises safety and energy efficiency, while an unbalanced load can lead to serious safety risks.

At any time, when cargo is being loaded onto an aircraft, there will be an appointed **loadmaster**. A loadmaster may be a regular crew member, the pilot, or in the case of large commercial operations, specially certified persons who work only in cargo loading. In any situation, the loadmaster is the person ultimately responsible for determining how and what gets loaded onto a plane

Cargo can be loaded into specially defined sections of an aircraft including:

- **Deck Cargo** – cargo loaded onto the main deck/body of an aircraft.
- **Belly Load** – cargo loaded onto the under deck/belly of an aircraft.
- **Nose Load** – cargo loaded into the front compartment of an aircraft.
- **Tail Load** – cargo loaded into the rear compartment/area past the rear wheel base of an aircraft.
- **Sling Load** – cargo carried below of a rotor wing aircraft using special netting, secured harnesses, and ropes.

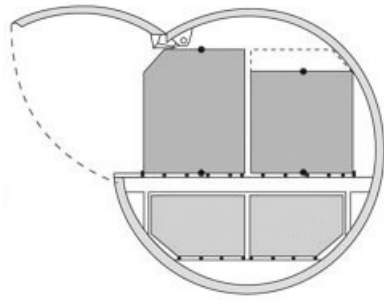

Side loaded cargo hold

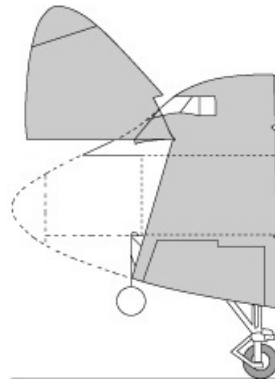

Nose loaded cargo hold

---

To accommodate the variance in the size needs for different airframes, cargo shipped via air tends to be “loose-loaded,” being loaded at the lowest handling unit (carton, sack, etc), so that handling crews can maximise space and shape cargo builds to fit the interior of the available cargo space. Oversized cargo, or pre-made pallets that don't fit the specific dimensions of the airframe in question will either not be loaded, or will need to be broken down into smaller units for loading.

Example upper deck of a cargo plane:

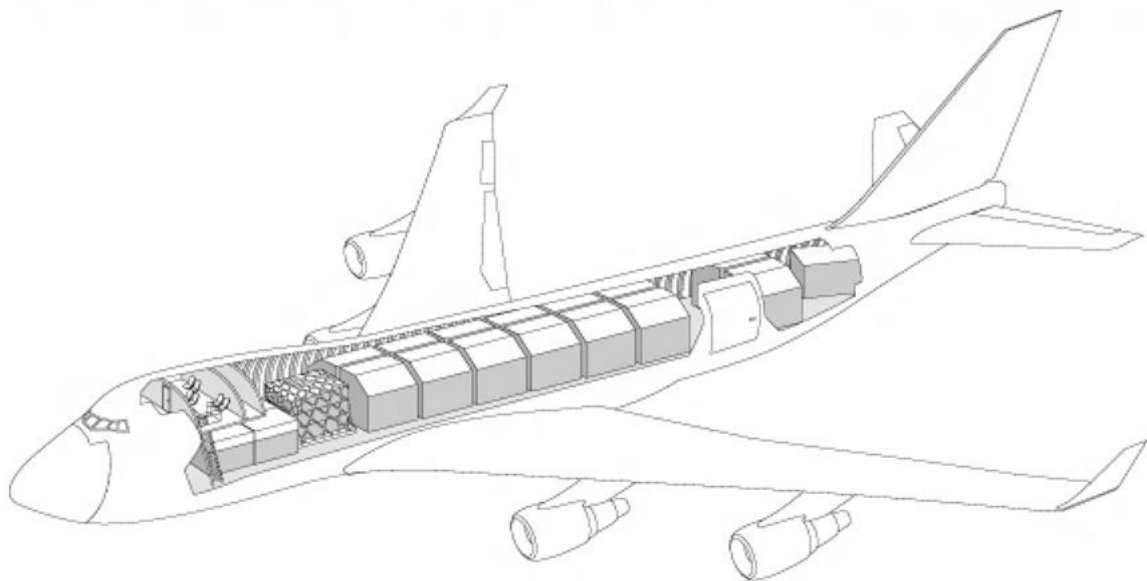

Cargo transported via rotor wing (helicopter) will follow the same general ideas, including limited size and shape of doors and cargo holds, and a comparably smaller maximum take off weights. Helicopters do have one advantage that fixed wing aircraft do not - the ability to transport bulky cargo outside of the aircraft using a sling load. Sling loading is relatively uncommon, and requires specialized equipment, a helicopter with the appropriate capabilities, and requires special pilot training.

Example cargo sling load in action.

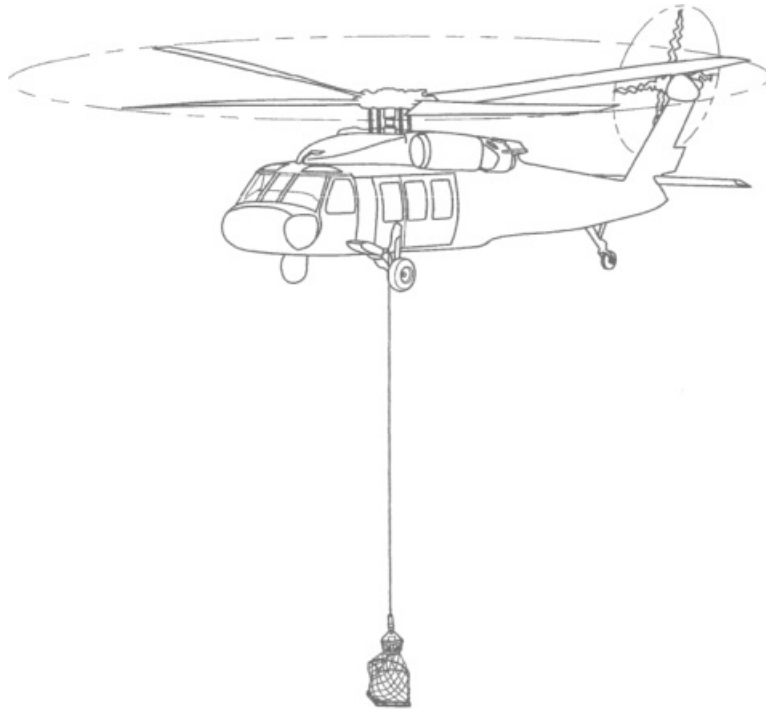

**Unit Load Devices** - Many aircraft will utilise what are known as "Unit Load Devices," (ULD) or pre-made containers that facilitate the easy transport of cargo via air. ULDs are sometimes referred to by the term "Build Up Pallets" or BUPs, however ULD is a more accurate term as many ULDs are not actually pallets, but rather custom designed frames of irregular shapes.

Each airframe has its own specific dimensions of UDL which are used internally by the air carriers and won't be the responsibility of the shipping party to obtain or manage. UDLs require the assistance of MHE or other vehicles to move and load, and are usually managed out of larger professional airport with trained ground crew. Understanding UDLs can help transport planning for shippers.

Some aircraft will load cargo on a type of UDL called an "airplane pallet" - the pallets thin sheets of metal that can be easily moved on rollers, and have much more storage surface than warehouse pallets. Airplane pallets come in a variety of sizes, and are usually purpose built for one or a few aircraft types. Cargo will be loaded loose on the pallet pre-shaped to match the interior of the specific aircraft in question, and will be covered in cargo netting. Airplane pallets and cargo netting can be very expensive, and should be treated as any other expensive equipment.

Example airplane pallet and netting:

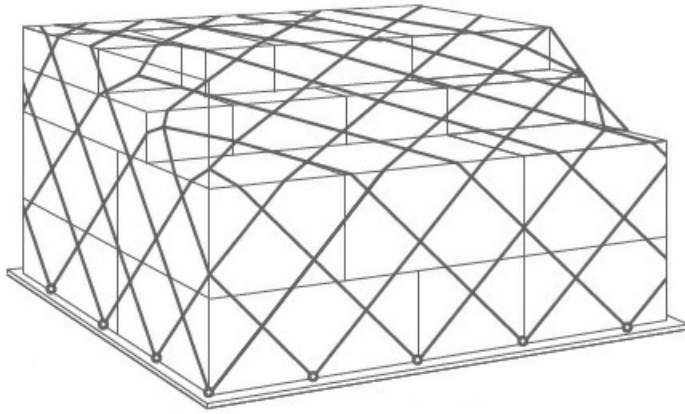

Larger and mixed-use aircraft will often use a form of UDL called a “contoured container.” Contour containers are solid containers with one or more rigid sides that are pre-shaped to match specific compartments inside of an aircraft. The containers are made of extremely thin metal, and are designed to take the guess work out of space planning. There are a variety of contour containers, including partially open containers, refrigerated containers, etc. The use of these specific variations will be decided by the airline and the load master based on the needs of the shipper.

Example contoured container:

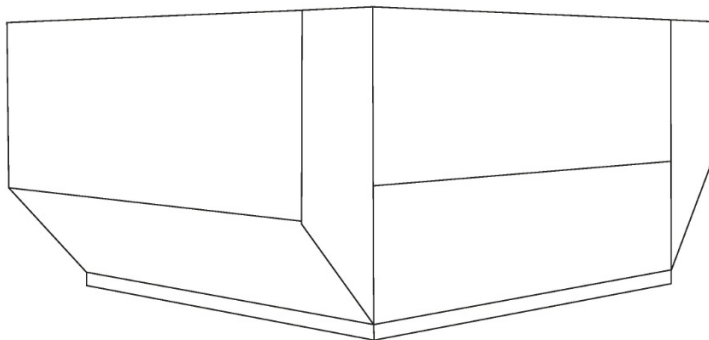

Many ULDs are custom designed for specific purposes, including transporting of refrigerated items or handling livestock. Any form of ULD usually requires specialised handling equipment, and won't be loaded or moved without a trained professional knowledgeable about the cargo, the aircraft and the ULD handling requirements.

**Hand Loading** – Aircraft used in smaller or irregular flights are often loose loaded by hand. This entails loaders and crew manually loading items into a cargo hold at the handling unit level, stacking and stuffing where ever space is available, and where ever is safe or appropriate. Aircraft used in humanitarian operations at the domestic level frequently use hand loading due to lack of equipment and aircraft type. Hand loading aircraft has limitations, including requiring additional time to complete and being less secure than netted cargo, but is useful insofar as it can be done in almost any environment and under almost any condition.









Regardless of ULD or hand loading method, each cargo hold maximum allowable weight may fluctuate from the published weight based on the weight of items loaded into other cargo holds. The Loadmaster should communicate payload limitations in advance and will control cargo at the point of loading.

## **Dangerous Goods (DG)**















Dangerous Goods (DG) has special packaging and labelling requirements. IATA [continually publishes an updated guide](#) for DG packaging and labelling for air transport. Dangerous goods of different classification will need to be labelled with the appropriate and corresponding label. Additionally, IATA and other safety guidelines may stipulate the maximum size and quantities of certain DG items that can be transported, and will stipulate any required “overpacking,” or an additional layer of packaging over the handling unit packaging. Packaging and labelling standards for cargo should be overseen by persons who are properly certified and accredited through an IATA approved DG certification program. Please consult the [Dangerous Goods section to this guide](#) for more detailed information.













## Aircraft Specifications for Cargo









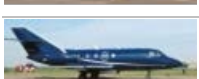





The below table contains a *non-exhaustive* list of cargo aircraft commonly used for domestic and international cargo movements. The weights and volumes in this table are only indicative of aircraft capacities under ideal conditions. [Real world conditions and limitations](#) will determine actual transport capacities. Please consult with air operators at the time of contract cargo service. A downloadable copy of this can [be found here](#).







Aircraft	Payload (kg)	Volume (m3)	Usable Hold Size (cm)			Door Size (cm)	
			L	W	H	W	H
 Piper PA-31	600	4	386	103	130	65	113
 Kingair 90	1,000	4	368	127	120	160	109
 Metro II	1,250	18	900	110	27	135	130
 Cessna 406	1,400	7	340	129	130	120	120
 Embraer Bandeirante	1,500	14	590	133	144	180	143
 Bell UH-1 Iroquois	1,760	6	262	233	132	188	122
 Dornier 228	1,950	18	635	127	147	133	138
 Metro III	2,000	12	918	115	105	135	130



Aircraft	Payload (kg)	Volume (m3)	Usable Hold Size (cm)			Door Size (cm)	
			L	W	H	W	H
	<b>2,041</b>	<b>10</b>	<b>609</b>	<b>152</b>	<b>140</b>	<b>187</b>	<b>140</b>
	<b>3,200</b>	<b>42</b>	<b>840</b>	<b>176</b>	<b>180</b>	<b>141</b>	<b>167</b>
	<b>3,850</b>	<b>36</b>	<b>1,110</b>	<b>162</b>	<b>175</b>	<b>135</b>	<b>130</b>
	<b>4,000</b>	<b>23</b>	<b>534</b>	<b>230</b>	<b>180</b>	<b>234</b>	<b>182</b>
	<b>5,000</b>	<b>7</b>	<b>452</b>	<b>130</b>	<b>132</b>	<b>120</b>	<b>120</b>
	<b>5,500</b>	<b>30</b>	<b>1,110</b>	<b>220</b>	<b>160</b>	<b>230</b>	<b>167</b>
	<b>5,700</b>	<b>51</b>	<b>1,385</b>	<b>226</b>	<b>175</b>	<b>127</b>	<b>153</b>
	<b>6,000</b>	<b>55</b>	<b>1,055</b>	<b>190</b>	<b>180</b>	<b>267</b>	<b>172</b>
	<b>6,000</b>	<b>62</b>	<b>1,524</b>	<b>210</b>	<b>190</b>	<b>232</b>	<b>178</b>
	<b>7,030</b>	<b>67</b>	<b>1,577</b>	<b>236</b>	<b>198</b>	<b>300</b>	<b>180</b>
	<b>8,165</b>	<b>52</b>	<b>957</b>	<b>266</b>	<b>208</b>	<b>250</b>	<b>208</b>
	<b>8,200</b>	<b>78</b>	<b>1,550</b>	<b>200</b>	<b>180</b>	<b>263</b>	<b>172</b>
	<b>8,200</b>	<b>76</b>	<b>1,796</b>	<b>226</b>	<b>175</b>	<b>127</b>	<b>153</b>
	<b>10,000</b>	<b>78</b>	<b>1,780</b>	<b>260</b>	<b>190</b>	<b>333</b>	<b>193</b>
	<b>10,000</b>	<b>52</b>	<b>1,050</b>	<b>215</b>	<b>220</b>	<b>240</b>	<b>227</b>

Aircraft	Payload (kg)	Volume (m3)	Usable Hold Size (cm)			Door Size (cm)	
			L	W	H	W	H
	<b>10,400</b>	<b>91</b>	<b>2,340</b>	<b>274</b>	<b>205</b>	<b>346</b>	<b>206</b>
	<b>10,886</b>	<b>42</b>	<b>930</b>	<b>229</b>	<b>198</b>	<b>220</b>	<b>190</b>
	<b>15,000</b>	<b>91</b>	<b>2,200</b>	<b>274</b>	<b>210</b>	<b>355</b>	<b>198</b>
	<b>18,000</b>	<b>85</b>	<b>1,355</b>	<b>280</b>	<b>240</b>	<b>280</b>	<b>240</b>
	<b>19,237</b>	<b>154</b>	<b>2,440</b>	<b>319</b>	<b>214</b>	<b>340</b>	<b>210</b>
	<b>19,275</b>	<b>130</b>	<b>2,324</b>	<b>317</b>	<b>214</b>	<b>348</b>	<b>216</b>
	<b>20,000</b>	<b>17</b>	<b>681</b>	<b>180</b>	<b>147</b>	<b>130</b>	<b>135</b>
	<b>20,000</b>	<b>110</b>	<b>1,200</b>	<b>320</b>	<b>310</b>	<b>290</b>	<b>320</b>
	<b>21,000</b>	<b>140</b>	<b>1,609</b>	<b>301</b>	<b>260</b>	<b>301</b>	<b>274</b>
	<b>24,042</b>	<b>186</b>	<b>2,712</b>	<b>351</b>	<b>213</b>	<b>340</b>	<b>218</b>
	<b>28,500</b>	<b>170</b>	<b>3,200</b>	<b>318</b>	<b>210</b>	<b>340</b>	<b>210</b>
	<b>36,000</b>	<b>238</b>	<b>3,327</b>	<b>353</b>	<b>213</b>	<b>340</b>	<b>218</b>
	<b>40,000</b>	<b>230</b>	<b>2,798</b>	<b>317</b>	<b>212</b>	<b>345</b>	<b>200</b>
	<b>40,500</b>	<b>270</b>	<b>3,300</b>	<b>477</b>	<b>240</b>	<b>318</b>	<b>244</b>

Aircraft	Payload (kg)	Volume (m3)	Usable Hold Size (cm)			Door Size (cm)	
			L	W	H	W	H
 McDonnell Douglas DC-8 54 55F	41,000	201	3,100	322	218	355	215
 Boeing B767-200F	42,000	367	3,116	442	250	340	244
 McDonnell Douglas DC-8 62F	42,000	220	3,300	322	218	355	215
 Airbus A300 B4F	44,500	300	3,550	477	245	318	244
 McDonnell Douglas DC-8 71 73F	45,000	302	3,900	313	210	350	216
 Airbus A300- A600F	47,000	426	4,070	528	245	358	256
 Ilyushin IL-76T and IL76-TD	48,000	180	1,850	345	325	345	325
 Boeing B767- 300F	54,000	450	3,890	450	250	340	250
 Lockheed L1011 TriStar	55,000	440	3,300	485	274	431	284
 Ilyushin IL-76TF	60,000	400	3,114	345	325	345	325
 McDonnell Douglas DC-10F	65,000	484	3,725	558	234	356	259
 Airbus A330-200F	70,000	475	5,882	528	245	358	256
 Boeing MD 11F	85,000	575	4,400	488	244	350	259
 Ilyushin IL-96- 400T	88,000	580	4,444	571	286	485	287

Aircraft	Payload (kg)	Volume (m3)	Usable Hold Size (cm)			Door Size (cm)		
			L	W	H	W	H	
	<b>Boeing B777-200F</b>	<b>103,000</b>	<b>653</b>	<b>4,412</b>	<b>582</b>	<b>315</b>	<b>372</b>	<b>315</b>
	<b>Boeing B747-200F</b>	<b>111,583</b>	<b>759</b>	<b>4,800</b>	<b>486</b>	<b>304</b>	<b>340</b>	<b>312</b>
	<b>Antonov An-124</b>	<b>120,000</b>	<b>750</b>	<b>3,648</b>	<b>640</b>	<b>440</b>	<b>640</b>	<b>440</b>
	<b>Boeing B747-400F</b>	<b>120,200</b>	<b>735</b>	<b>4,800</b>	<b>486</b>	<b>304</b>	<b>340</b>	<b>312</b>
	<b>Boeing B747-8</b>	<b>140,000</b>	<b>857</b>	<b>5,430</b>	<b>486</b>	<b>304</b>	<b>340</b>	<b>312</b>
	<b>Antonov An-225</b>	<b>250,000</b>	<b>1,100</b>	<b>4,535</b>	<b>640</b>	<b>440</b>	<b>640</b>	<b>440</b>

Adapted from [Air Charter Service](#)

Title

Download - Aircraft Cargo Specifications

File



## Sea Transport

Cargo transport by sea is by far the cheapest per kilogram per kilometre moved relative to the other major forms of transport used by other humanitarian agencies, and is convenient for bulky pre-planned consignments. Sea transport is unfortunately also one of the slowest methods of delivering cargo as well. Sea transport will likely not be used to service immediate needs in rapid on-set disasters, and is more appropriate for pre-positioning or to serve post disaster and longer term needs.

## Common Terms in Sea Transport

**Shipping Container**

A standard predefined set of containerised shipping units that are used throughout all sea shipments. Shipping containers come in many variations to meet the needs of different shipments. Containers also have unique container numbers that can be tracked, and when in movement containers will be sealed using industry standard container seals. The vast majority of containers come in 20 foot and 40 foot dimensions.

---

**Full Container Load (FCL)**

A volume of cargo from a single party or consignment capable of filling an entire shipping container.

---

**Less Than Container Load (LCL)**

A volume of cargo from a single party or consignment not capable of filling an entire shipping container.

---

**Twenty Equivalent Unit (TEU)**

Short hand for identifying a measure of volume equivalent to the container size and identifying slot space on a dock or a ship. One 20-foot container is equal 1 TEU.

---

**Forty Equivalent Unit (FEU)**

Short hand for identifying a measure of volume equivalent to the container size and identifying slot space on a dock or a ship. One 40-foot container is equal 1 FEU or 2 TEUs.

---

**Port of Loading (POL)**

The port at which a cargo is loaded onto a vessel and disembarks.

---

**Port of Discharge (POD)**

The port at which a vessel arrives and unloads cargo.

---

**Direct Service**

Vessel Schedule wherein cargo is loaded/unloaded from the same vessel.

---

---

<b>Transshipment Service</b>	A shipment where a container changes multiple ships throughout the transport, where cargo is offloaded at another port to connect to the vessel destined to the final point of delivery. There can be a single transshipment or multiple transshipments.
<b>Live Load / Unload</b>	When a forwarder or transport company sends or drops a container at a shipper's facility and waits for the container to be loaded / unloaded without leaving within a stipulated period of time.
<b>Drop and Pick</b>	When a forwarder or transport company leaves a container at a shipper's facility for one or more days without being present for the loading / unloading.
<b>Stripping</b>	Removing contents from a container, either at the port or consignee's location. May or may not involve breaking the container seal; a container may be opened prior to delivery for a variety of reasons including inspection and breaking down of a consolidated consignment. Also sometimes called destuffing or devanning.
<b>Stuffing</b>	Loading a container for shipping, at a container freight station, consignees' location or consolidation warehouse somewhere in the middle. Sealing the container may or may not occur at point of stuffing.
<b>Shipside / Quayside</b>	Storage and handling of cargo occurring at a port alongside or near a sea transport vessel.
<b>Berth</b>	A designated location in a port where a vessel can park and moor, usually along the long edge of a ship to provide safe and easy offloading. Maritime vessels vary dramatically in size, both in length and depth under the water they may draft, so berthing space must be designated by a port captain or port official, and must match the needs of the vessel.
<b>On Deck Stowage</b>	The placement of cargo and containers stored on the surface deck of a ship for the duration of the transport. On deck refers to anything above below deck storage with free access to the air above the boat, however on deck storage might still start below the upper rim of the vessel.
<b>Below Deck Stowage</b>	The placement of cargo below the main deck of a shipping vessel.

---

---

<b>Bulk Carrier</b>	A vessel specially designed to transport unpackaged bulk cargo, such as grains, coal, ore, steel coils and cement, in its cargo hold(s). Bulk carriers are ideal for transport of grain or loose materials that may be removed with special equipment on the receiving end. Frequently, bulk carriers will require re-bagging on the receiving end of the shipment.
<b>Break Bulk</b>	Cargo transported in large, unitised quantities not contained in a standard shipping container. Break bulk cargo may be items like large machine parts, construction materials or even vehicles, and can be stored in specialised below deck compartments.
<b>RoRo</b>	Any vessel that has capacity for vehicles to “Roll on / Roll off.” Might include regular vehicle ferry service, but also many long haul ships may have this capability.
<b>Stevedore</b>	A dock worker engaged with loading, offloading and management of maritime shipping activities.

---

## Sea Transport Arrangements

Very rarely are sea cargo vessels owned or wholly leased by single agencies that also solely utilise them for their own shipping purposes. The overall size, cost, time and general nature of sea freight necessitates that no single entity but those with massive and regular volumes of cargo could ever utilise an entire vessel at once. The vast majority of sea cargo is arranged through freight forwarders, and is negotiated based on the POL/POD, consignment size, type and special handling needs. Shippers sending any goods via sea should liaise with their forwarders to identify the correct modality of moving their cargo from one place to another.

In sea shipping, there are heavily trafficked and well-known routes that many vessels use known as “shipping lanes,” especially between high volume ports. Between these shipping lanes, there are also what is known as “shipping lines,” or fleets of shipping vessels privately owned and managed by a company or a consortium. In addition to shipping lines, there are also a variety of smaller merchant fleets and individual vessels who work on contract for cargo movement.

Due to the sheer number of individual shippers that may be sending cargo on a single vessel, it's extremely unlikely any one vessel will be departing from and arriving at the exact destination specified by the shipper. Cargo shipped via sea faring vessel will frequently use transshipment service, being offloaded and reloaded onto two or more vessels while en route, staying in a secure port in between loadings while waiting for the correct vessel heading the correct destination. The linkages of a transshipment service are worked out by brokers and forwarders on behalf of the shipper, and shippers usually don't get involved with routing, only becoming involved with cargo at the final destination.

**Containerisation / Loose Item** – The preferred method of shipping via sea is the use of containerised units. Shipping containers, through their standardised construction, fit onto a wide variety of sea faring freight vessels. Containers are usually sealed at the POL, and as such can switch between multiple vessels and ports while en route with minimal risk of tampering or

theft. Generally, shippers should seek to maximise their shipments by trying to reach a whole number of either 20 foot (TEU) or 40 foot (FEU) container or containers. Loads smaller than a full container load (FCL) might have to wait until a full container load is available, otherwise shippers might have to rely on what is known as “consolidation,” or sharing of one container with one or more other shippers. Less than container load (LCL) cargo using consolidation might require waiting to find another shipper or shippers going to the same final destination as the shipper. Consolidation also does not allow for fully unopened containers to be delivered to a consignee’s facility as the cargo will need to be broken down and separated at the port, which increases the chances of loss or theft.

Special items such as generators or vehicles that cannot fit into a container, or special handling containers like refrigerated containers (reefers) may also be transhipped using two or more vessels. For oversized or bulky items, they may also be shipped by the piece, however there may be fewer available vessels with the right stowage space heading to the correct locations, which might drive up costs and slow down the entire process of shipping.

**Dedicated Charters** – Occasionally an agency or organisation will need to take full possession of a vessel for a single voyage or for an extended period of time. These vessel specific charters are governed by a contracting structure known as a “charterparty.” In a charterparty arrangement, the ship owner provides the vessel as a dedicated resource along with crew, and usually provides for the cost of fuel and maintenance, though the specifics of the arrangement are identified in the contract. Examples of dedicated charters in humanitarian aid might include:

- Leasing an entire bulk carrier vessel for the movement of loose grain from one location to another
- Long term leasing a cargo vessel to provide regular cargo service to locations not serviced by the commercial market
- Long term leasing of passenger vessels for special purposes (hospital boats, rescue boats, etc)

## Unique Concepts to Sea Transportation

**Port Demurrage** – Sea cargo in a port accrues demurrage at a different rate than airports or border crossings. Due to the size and complexity of port operations, containers and bulk cargo items are typically given two weeks of free storage before demurrage accrues. This port demurrage rate is variable however, and free demurrage may vary for container and break bulk cargo based on the carrier agreement with the port, the shipping line companies, and the local governments ranging from two days to fourteen days.

**Flag Carrying Vessel** – The majority of the surface area of the world’s oceans are considered international waters, and vessels themselves may spend the majority of their time in non-incorporated international water. By binding international maritime law, all vessels must still be registered as a “flag carrier” for some country on earth. A vessel carrying the flag of a certain country does not mean the vessel was manufactured there, nor does it mean the crew or anything about the operation is connected to that country, it only means that’s the country the vessel is registered in. By regulation, vessels must spend at least some portion of the year docked in the country through which they are registered. Regulation also states that the country to which the vessel is registered has the ultimate authority and responsibility to enforce safety and pollution standards, and prosecute any violators under local law.

**Vessel Limitations** – Modern shipping vessels are becoming larger and more sophisticated, however it is extremely difficult - and at times impossible - to update seaports to



accommodate these ships for a number of reasons. Additionally, many vessels might require additional specialised [Material Handling Equipment \(MHE\)](#) that isn't always available in every port, especially under developed or neglected ports in countries prone to natural disasters and conflicts. Limitations vessels might face include:

- **Hull Draft** – Some vessels have drafts too deep for some harbours, which are limited by the natural topography of the ocean floor.
- **Offloading** – Smaller and unimproved seaports may lack the offloading equipment to move containers and bulky items. Vessels moving these items may need deck mounted cranes to move items themselves.
- **Size** – Vessels that are too long may not be able to adequately berth to offload cargo.
- **Flag Carrying Vessels** – Some vessels may be banned from entry to harbours due to their source origin or registered flag.

## Port Operations

Seaports can be enormous compared to other ports of entry, such as an airport or a border crossing. Seaports must be large enough to accommodate vessels of various sizes, but also can have an extremely large storage and holding capacity. The largest container ports in the world process tens of millions of TEU containers each in a single year. Large ports can be extremely busy, with dozens of ships being loaded and offloaded with specialised cranes and MHE at any given time. Ports also tend to be highly secured and scrutinised – due to the high volume of goods, illegal smuggling and human trafficking have become large concerns for many countries. Based on the sheer size of the operations, vessels may not be able to berth or off load for days or even weeks, instead having to moor off coast waiting for berthing space to open up. It's also very common for cargo to be delayed while being offloaded and moved around a port, especially in chaotic post emergency periods.

Port limitations can also impact the speed at which cargo can be offloaded, or even prevent offloading at all. Things such as the number of operating cranes, the number of available truck drivers or the available hands to move cargo may lead to significant port congestion. The lack of the appropriate handling equipment can adversely limit a port to the point it cannot service some vessels. In countries or locations with limited or unimproved facilities, it may be impossible to off load certain vessels. Small ports may lack cranes sufficient to move full sized containers or oversized cargo, requiring vessels to carry their own on-board MHE. Even if a port has proper MHE, if the equipment is old, poorly serviced, or the ground operators have limited or poor training, offloading and releasing cargo can be slowed down substantially.

Example Port Operation Overview:

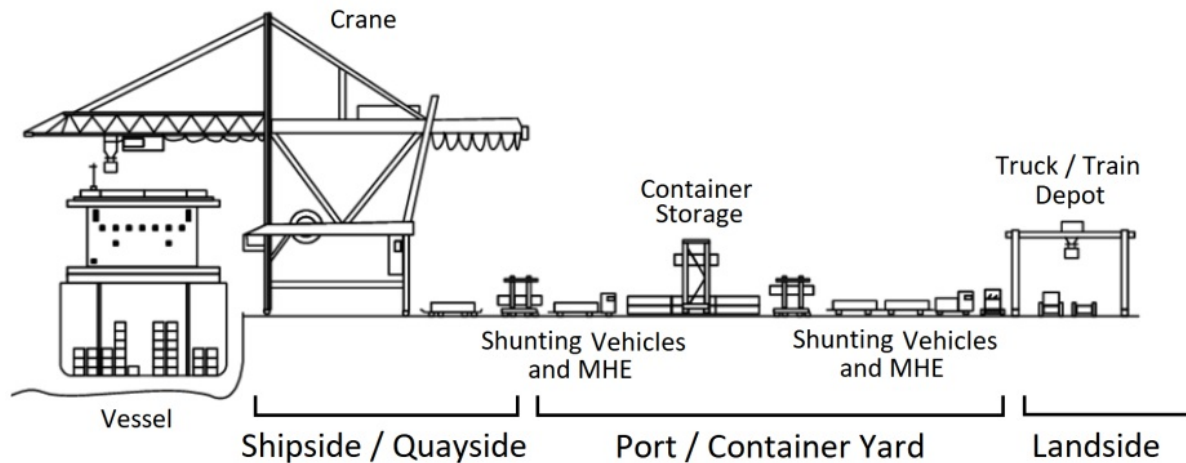

## Material Handling Equipment

Ports require specialised equipment to load and offload cargo from vessels. In sea operations, cargo normally arrives containerised, however cargo can also be oversized or bulk. Special equipment is required to properly load and offload items.

**Reachstacker** - Large vehicle designed to pick up and carry full-sized containers around a container yard. Reachstackers have different sizes, and may have maximum load limits under a fully loaded container. Reachstackers are usually not used for offloading vessels, unless the vessels are small and in unimproved port conditions - they are mostly used for rearranging containers in a shipping yard, or loading containers onto truck bodies for onward movement.



**Shipside Container Crane** - A large crane capable of offloading full-sized containers directly from the deck of a ship. Shipside container cranes may either be stationary, or capable of moving to meet the needs of the operation. The cranes are usually very tall - well above the decks of most vessels rated for that port and are capable of lifting loads up to the max weight of containers.



**Gantry Crane** - Another form of movable container crane, one that specifically straddles both side of a vessel or stack. Gantry cranes can be large enough to reach over the deck of an entire vessel, but may also be used for loading and offloading trucks or piles of cargo.



**Unloader / Grain Vacuum** - A specialised tool for offloading loose, bulk cargo such as grain or sand with an extended adjustable arm that reaches into the deck of a bulk carrier. Unloaders can have a mechanical function, scooping and lifting bulk cargo like an elevator inside the arm. There are also configurations where the arm is a giant vacuum for grains called a "grain vac", that pushes loose grain out the back to a pre-set destination.



**Ship with Deck Mounted Cranes** - Some ships may require their own onboard mounted MHE, such as deck mounted cranes. On-board MHE helps alleviate the problem of working within ports that have limited handling equipment.



**Grain Conveyor** - A large mechanical conveyor that can either lift and dump grain, or be used to slowly offload grain from the belly of a bulk carrier. If used for offloading, there is usually a bagging operation occurring at the receiving end.



**Sending Goods by Sea**

## Sea Transport Documentation

The overall requirements for and types of documentation used for sea transport remain consistent with most shipments ([waybill](#), [packing list](#), [proforma](#), etc). There are documents specific to sea shipping however. These might include:

**Bills of Lading (BOL)** - The BOL is the transport waybill for a sea freight consignment. BOLs are conceptually one of the oldest mutually recognised forms of consignment tracking; traditionally seaborne trade was one of the few ways countries conducted official trade. The BOL states to whom and on what terms the goods are to be delivered at destination. It is one of the most crucial documents used in international trade in that it ensures the shipper receives their payment and the consignee receives their cargo, and without an official BOL the goods will not be released. Modern BOLs are highly standardised, and BOLs generated by different shipping lines will look almost identical in layout. Many shipping companies will require BOLs even if the vessel is not moving between two different countries – the BOL also represents a contract between the vessel owner and the owner of the good being shipped.

There are three types of BOL arrangements that can be used:

- **Original BOL** - Consignee has to handover all three sets of original BOLs to their customs agent at destination to release the cargo. With original BOLs, possession of the goods is determined by possession of the BOL - whoever possesses the original BOLs may be entitled to demand possession of the goods from the carrier. Shipments using original BOLs may be delayed if the documents are lost or not in hand at the time of clearing.
- **Seaway BOL** – Original BOL is not required and cargo can be released directly to the consignee by their customs agent. Seaway BOLs are useful because the physical document does not need to be present, and the consignee can begin clearing as soon as cargo arrives. Many banks do not accept Seaway BOLs if a letter of credit is required however.
- **Telex Release BOL** – In telex BOLs, the supplier surrenders the original BOL to their export/forwarding agent at origin and transmits using telex directly to customs at destination request to release of cargo to the consignee.

BOLs are usually issued in a set of three originals and several non-negotiable copies. The BOL is signed on behalf of the ship owner by the person in command of a ship or the shipping agent, acknowledging the receipt on board the ship of certain specified goods for carriage. It stipulates the payment of freight and the delivery of goods at a designated place to the consignee therein named.

The BOL is the major shipping document and has three roles:

- It affirms the contract of carriage and sets out the terms thereof. It is evidence of the contract between the consignor and the shipping line, and on the reverse details the conditions of carriage.
- It is the carrier's receipt for the carriage of goods by sea and is signed by the master or another duly authorised person on behalf of the ship owner, acknowledging receipt on board the ship of certain specified goods that he undertakes to deliver at a designated place.
- Possession of the original BOL gives the title to the goods being carried. It is considered good practice for the consignor to ensure that at least one original BOL reaches the consignee in good time since the consignee will receive the goods only against presentation of at least one original BOL.

## Terms of the BOL:

There are three different entries possible in the box headed "consignee":

- **To bearer:** this means that any person having possession of the BOL may collect the goods; such person is not required to disclose their identity or to explain how they came into possession of the BOL. The mere fact that they have possession of and present the BOL is sufficient. Issuing BOL "to bearer" is not common practice and carries significant risk.
- **To order:** this is the form of BOL used most frequently in commercial transactions. As long as the shipper holding the BOL has not endorsed it, he is entitled to dispose of the goods. By endorsing it, he transfers his rights to the endorsee, that is, the person to whom the BOL is assigned by endorsement. Title to the goods is thereby transferred to the new holder of the BOL who may in turn assign it by endorsement to somebody else.
- **To a named party (straight BOL):** in contradiction to a BOL "to order", the straight BOL - one in which it is stated that the goods are consigned to a specified person - does not entitle the shipper to dispose of the goods. That right is vested exclusively in the receiver who alone has the right to collect the goods, upon presentation of the BOL and proof of his identity. Named parties are by far the most common and secure form of named consignees.

Other commonly used BOL terms:

- **Straight BOL** - Assigned by means of a document instrument in writing, evidencing the assignment, which the assignee must present to the master of the vessel together with the original BOL when he collects the goods. On a straight BOL, the term "to the order of" printed on standard BOL must be crossed out, and the deletion initialled by both the shipper and the Master.
- **Clean BOL** - Declares there is no damage or loss of cargo in transit. Goods may sometimes be 'received alongside', which can result in a delay prior to the physical loading of the goods onto the vessel.
- **Unclean BOL** - Contains a notation that goods received by carrier were defective or damaged.
- **Through BOL** - Issued when a shipper wishes the carrier or shipping line to arrange for transport to a destination beyond the port of discharge. The through BOL, in addition to the agreement to carry goods from port to port, includes a further journey (by sea or land) from the port of ship's destination to a distant place (for instance, a destination inland instead of a port).
- **House BOL (HBL)** - An internal document generated by a forwarder or broker to provide relevant information to a client. HBLs may not always be presented as official documentation used during the customs process.
- **Master BOL (MBL)** - the official BOL generated by the shipping line or vessel operator. MBLs will generally bear the most accurate information, and many customs authorities will only use MBLs for customs clearance purposes.

Example BOL:

**MASTER  
BILL OF LADING  
Conocimiento de Embarque**

XXXXXX LINER SERVICES					
(2) SHIPPER (Complete Name, Address & Zip Code) Embarcador  Shipper's Name Mailing Address Including City, State and Zip Code		(3) BOOKING NO. Reserva No. <b>CAT - XXXXXX</b>		(3c) SCAC Code <b>CAMN</b>	
(5) CONSIGNEE (Complete Name, Address, & Zip Code) Consignado a: Not Negotiable unless consigned "To Order"  Consignee's Name Complete Mailing Address Including City, State and Zip Code		(6) FORWARDING AGENT Agente Embarcador-Referencias		(3a) BILL OF LADING NO. Conocimiento de Embarque  FWDR REF. NO.	
(7) NOTIFY PARTY (Complete Name, Address, & Zip Code) Dirigir Notificación de Llegada a:  Contact Information for Person to be notified at Destination include Full Name, Phone Number and/or E-mail Address		(8) ALSO NOTIFY - ROUTING & INSTRUCTIONS Tambien Notificar - Ruta Doméstica/Instrucciones de Exportación			
(9) VESSEL Nave VOYAGE Viaje FLAG Bandera		(10) PLACE OF RECEIPT *Carga Recibida en:  (13) PORT OF LOADING Puerto de Carga <b>Enter Port Delivered to</b>		(11) RELAY POINT Punto de Conexión  (14) LOADING PIER / TERMINAL Muelle	
(16) PORT OF DISCHARGE Puerto de Descarga <b>Enter Final Destination</b>		(17) PLACE OF DELIVERY *Lugar de Entrega de la Carga		(12) POINT AND COUNTRY OF ORIGIN OF GOODS Lugar y País de Origen  (18) ORIGINALS TO BE RELEASED AT Originales para Entregarse en: <b>Enter Releasing Instructions for Original Bills of Lading</b>	

**PARTICULARS FURNISHED BY SHIPPER**

(19) MARKS & NO'S/CONTAINER NO'S. Marcas y Números	(20) NO. OF PKGS. / CONT'S. / PIGS. / No. de Paquetes/ Bultos	(21) HMT*	(22)	DESCRIPTION OF CARGO Contenido Según Embarcador	(23) WEIGHT Libras/Kilos	(24) MEASUREMENT Medidas

(25) \*\* HAZARDOUS DECLARATION - THIS IS TO CERTIFY THAT THE ABOVE NAMED MATERIALS ARE PROPERLY PACKED, LOADED, CLASSIFIED, DESCRIBED, MARKED, LABELLED, SEGREGATED AND ARE IN PROPER CONDITION FOR TRANSPORTATION ACCORDING TO ALL APPLICABLE REGULATIONS AS SPECIFIED IN CLAUSE 26. PROVIDE SHIPPER'S EMERGENCY RESPONSE CONTACT'S NAME AND TELEPHONE NUMBER INCLUDING AREA CODE IN THE SPACE PROVIDED.

				CONTACT:		TEL. NO.
Signature						
FREIGHT CHARGES Flete	RATED AS Flete Básico	PER	RATE Tarifa	TO BE PREPAID IN US DOLLARS Prepagado en Dolares U.S.	TO BE COLLECTED IN US DOLLARS A Cobrar en Dolares U.S.	FOREIGN CURRENCY Moneda Local

THIS BILL OF LADING CONSISTS OF CONDITIONS AND INFORMATION APPEARING ON THE FRONT AND BACK OF THE DOCUMENT. SUBJECT TO SECTION 7 OF CONDITIONS, IF THE SHIPMENT IS TO BE DELIVERED TO THE CONSIGNEE WITHOUT RECOURSE ON THE SHIPPER, THE SHIPPER SHALL SIGN THE FOLLOWING STATEMENT: "THE CARRIER SHALL NOT MAKE DELIVERY OF THIS SHIPMENT WITHOUT PAYMENT OF FREIGHT AND ALL OTHER LAWFUL CHARGES."

SIGNATURE OF SHIPPER: \_\_\_\_\_

LIABILITY LIMITED UNLESS INCREASED VALUE DECLARED BELOW, ALL AS SPECIFIED IN SECTION 16:

DECLARED VALUE: \_\_\_\_\_

\*\* APPLICABLE ONLY WHEN USED AS A THROUGH TRANSPORTATION BILL OF LADING.

\*\* INDICATE WHETHER ANY OF THE CARGO IS HAZARDOUS MATERIAL UNDER DOT, IMCO OR OTHER REGULATIONS AND INDICATE THE CORRECT COMMODITY NUMBER IN DESCRIPTION OF CARGO ABOVE.

**TOTALS**

IN WITNESS WHEREOF THE CARRIER HAS SIGNED \_\_\_\_\_ ORIGINAL BILLS OF LADING, ALL OF THE SAME TENOR AND DATE, ONE OF WHICH BEING ACCOMPLISHED THE OTHERS STAND VOID.

BY \_\_\_\_\_  
CARRIER: LINER SERVICES

BY \_\_\_\_\_  
FOR SHIPPER

**Non-Traditional Movement** – there may be instances in which cargo is moved via a seafaring vessel in which no BOL is used. Such an instance might be when cargo is moved using ocean waterways without moving between two countries, when the sea carrier or vessel owner isn't large enough to participate in regular maritime shipping practices, and when natural disasters or conflicts preclude the normal procedures associated with sea shipping. In such instances, individuals or organisations should still endeavour to utilise standard shipping best practices, such as use of packing list and waybill, to prevent loss or theft along the way.

# Cargo Configuration for Sea Shipping

Cargo shipped via sea tends to require a lower attention to detail, especially if cargo is shipped using standard shipping containers. There are still a few things shippers should know when prepping cargo for sea movement however.

## Container Shipping

Modern [shipping containers](#) have standardised interior, exterior and door dimensions. Containers also have pre-defined weight limits, set by the structural integrity of the containers and the rating on the cranes and vehicles used to move them. Shipping container weight will often be discussed in the following terms:

- **Tare** – The weight of an empty container; weight generated by the container it self.
- **Net** – The weight of the goods placed in the container.
- **Gross** – The combined weight of the container and the contents of the container.

Containers may be made of different materials, altering the tare and gross weight availability.

Example container carrying vessel:

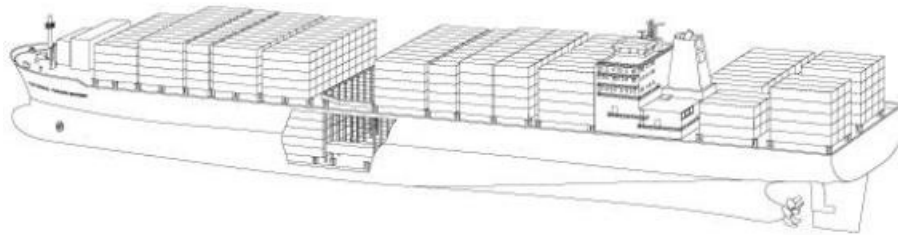

Though there are dozens of varieties of containers available to meet a number of needs, the vast majority of containers what are known as "dry containers" at either 20 foot (TEU) or 40 foot (FEU) sizes. TEU and FEU are totally enclosed, and though they are called "dry" are not actually hermetically sealed. The containers themselves are lockable and stackable, with two TEUs being able to be loaded on top of or below an FEU. Standard dry containers are mostly made from steel, however aluminium varieties are available.

As containers move, they are physically "sealed." A seal is usually a metal or plastic lock that can only be closed once. The only way to remove the lock is to physically cut it, thereby "breaking the seal." Container seals don't provide any form of structural security to the containers themselves, rather they are used as the process of tracking chain of custody. A proper container seal should have a tracking serial number on it. That serial number should be recorded at the point of sealing, and communicated to the ultimate recipient for cross reference. If the seal on the container at the receiving end does not match match the seal at the beginning of the journey, then theft or tampering may occur. Based on the volume of sea shipping, container numbers are frequently only checked if there is problem with the piece counts or product identification.

Container Chain of Custody:

- **Container Stuffing** - When an empty container is filled or "stuffed" with cargo to be shipped. Stuffing can be done either at the customer's location, or at the port. Stuffing can be the responsibility of the customer, or for a designated third party designated in



the terms of the contract.

- **Sealing the Container** - Sealing occurs after a container has been stuffed. Physically setting the seal can be the responsibility of the customer, or a third party company/agent identified by the customer.
- **Unseal the Container** - Breaking occurs at the end of the sea journey, and in the presence of the customer or the designated third party company/agent. Breaking can occur either at the port, or the container can be delivered all the way to the customer's location.
- **Container Stripping** - When a full container has its contents removed or "stripped" of its cargo. Container stripping can occur at the port, or at the customer's location, and is the responsibility of the customer or a designated third party designated in the terms of the contract.

#### Stripping/Stuffing Process

- When a container is dropped at a customer's location and left to be stuffed or stripped later, it is called "drop and pick." Drop and picks can be for a specific pre-defined interval, or they can be for as long as required by the client/contract. Drop and picks are good for clients who like to stuff/strip and seal/unseal containers themselves.
- When a container is stuffed at the time the container is made available, it is called "live loading." Live loading is the same process as loading onto a box truck, and usually containers are truck mounted if at a customer's facility.

#### Example Container Seals:



The process of stuffing/Stripping and sealing/unsealing can be entirely outsourced to a third party. Many organisations who deal with less than full container loads rely on consolidators or third parties to take and ship their cargoes for them, ensuring all formalities are taken on their behalf. Self managed stuffing/stripping and sealing/unsealing is largely only useful for shippers who move large volumes of cargo and have robust supply chain monitoring processes in place.

When planning shipments in an TEU or FEU, shippers should consider the width, height, and total volume of a container. As an example, the interior width of a standard FEU is just under 2.4 meters while the width of [a standard north American pallet is just over 1 meter on the short end while just over 1.2 meters on the long end](#); loading using this pallet type using any side by side configuration will inevitably mean losing some usable free space. The same goes for oversized pallets – pallets of excessive height will not be able to fit through doors if they

exceed the door height, especially if pallets are moved by a hand truck or other form of MHE, meaning there will still be several centimetres of clearance required for the pallet to be picked up off the ground.

Cargo that is loose loaded into a container by hand may be able to fill up every available space, but loading and offloading cargo by hand can take extremely long periods of time. Unless a transporter is willing to do a drop and pick, the use of handloading may even be prohibitive. Additionally, many containers may be emptied and transloaded onto another truck where intermodal arrangements are not available, which would delay the process even further while increasing the risk of damage to cargo. In large scale response operations, shippers may opt to use palletised loading just to speed up the front and rear ends of the delivery.



TEU and FEU Dry Container									
Type	Container Weight			Interior Dimensions				Door	
	Gross	Tare	Net	Length	Width	Height	Capacity	Width	Height
	(kg)	(kg)	(kg)	(m)	(m)	(m)	(m3)	(m)	(m)
20 ft	24,000	2,370	21,630	5.898	2.352	2.394	33.2	2.343	2.28
40 ft	30,480	4,000	26,480	12.031	2.352	2.394	67.74	2.343	2.28

Title

Download Guide - Container Specifications

File



Outside of the standard TEU and FEU dry container, there are several common types of shipping containers to meet different needs.

- **Open Top/Side** - Some containers come with open tops or open sides to accommodate oversized cargo such as vehicles. The containers will still have bases of regular dimensions to facilitate stacking and moving via cranes, however.
- **Oversized** - Some containers are made especially long or especially high to accommodate larger loads. Only special vessels and ports can accommodate this type of container however.
- **Cold Storage** - Cold storage or refrigerated "reefer" containers are used for transmission of any climate controlled or cold chain items. Reefer containers are designed to transport cold requirement items over the entire sea voyage, and require constant connection to electricity or fuel to maintain low internal temperatures. Self-contained reefers can technically be transported on any vessel that can accommodate regular TEUs and FEUs, but special training and handling may be required.



Refrigerated "Reefer" Containers									
Type	Container Weight			Interior Dimensions				Door	
	Gross	Tare	Net	Length	Width	Height	Capacity	Width	Height
	(kg)	(kg)	(kg)	(m)	(m)	(m)	(m3)	(m)	(m)
20 ft	24,000	3,050	20,950	5.449	2.29	2.244	26.7	2.276	2.261
40 ft	30,480	4,520	25,960	11.69	2.25	2.247	57.1	2.28	2.205



Open Top Containers									
Type	Container Weight			Interior Dimensions				Door	
	Gross	Tare	Net	Length	Width	Height	Capacity	Width	Height
	(kg)	(kg)	(kg)	(m)	(m)	(m)	(m3)	(m)	(m)
20 ft	24,000	2,580	21,420	5.629	2.212	2.311	32	2.33	2.263
40 ft	30,480	4,290	26,190	11.736	2.212	2.311	64.4	2.33	2.263



High Cube Containers									
Type	Container Weight			Interior Dimensions				Door	
	Gross	Tare	Net	Length	Width	Height	Capacity	Width	Height
	(kg)	(kg)	(kg)	(m)	(m)	(m)	(m3)	(m)	(m)
20 ft	30,480	3,980	26,500	12.031	2.352	2.698	76.3	2.34	2.585
40 ft	30,480	4,800	25,680	12.031	2.352	2.698	86	2.34	2.585



Flat Rack Containers									
Type	Container Weight			Interior Dimensions				Door	
	Gross	Tare	Net	Length	Width	Height	Capacity	Width	Height
	(kg)	(kg)	(kg)	(m)	(m)	(m)	(m3)	(m)	(m)
20 ft	30,480	2,900	27,580	5.898	5.624	2.236	27.9	N/A	N/A
40 ft	34,000	5,870	26,480	28,130	11.786	2.236	27.9	N/A	N/A

Title

Download Guide - Container Specifications

File



### Pallets in Containers

Transport of cargo in containers is frequently done utilising pallets.



Based on the pallet types, different quantities might fit into different containers. In the situation pallets are not too tall to fit through container doors, a general guide for estimating pallets per container is:

Pallet Type/Size	Pallets per Container	
	20 Ft Container	40 Ft Container
<b>Euro Standard (120 x 80 cm)</b>	11	23 or 24
<b>Europe, Asia (120 x 100 cm)</b>	10 or 11	20 or 21
<b>North American (121.9 x 101.6 cm)</b>	10	20

### Oversized Cargo

Sea shipping is ideal for extremely large cargo; the cargo holds of larger ships can handle excessively large items, while the MHE used in port operations can handle weights not common in air or trucking. For transportation of oversized items, shippers must obtain proper exterior dimensions, and in the case of machine equipment, should obtain detailed material handling specifications available from the manufacturer or in the equipment manual. Non containerised shipments may take some time to formalise, as a break bulk carrier with the appropriate size hold and free space may not be readily available. Additionally, it may be difficult to find vessels utilising the correct routing to arrive at a shipper's intended destination. Shippers should begin conversations early with forwarders to determine the time and information needs to successfully ship bulk cargo.

### Bulk Dry / Loose Cargo

Sea faring vessels have a unique capacity to carry enormous quantities of un-packaged bulk cargo; cargo that is loose dry cargo such as grain or ore. Bulk carriers can hold high volumes of loose items in one or a few large cargo holds in the middle of the vessel. Unlike containerised vessels, it is highly unlikely that bulk carriers would undergo a transshipment process – the act of getting loose bulk off and back on a ship is very energy intensive. Bulk carriers require special equipment and training to load and off load. Loading can occur with cranes or grain elevators, while offloading requires special cranes to scoop or even suck up fine granules. Depending on the needs on the ground, bulk cargo operations might even undergo bagging directly at the point, to facilitate quick loading onto trucks for onward movement. Bulk cargo vessels are common for food operations in humanitarian response.

## Physical Cargo Needs

Due to the long duration of sea shipping, shippers should be mindful of cargo that may have sensitivities to temperature, or have specific expiration dates. Cargo shipped in a container along regular shipping lanes may easily take up to two months to reach its destination, especially when customs clearance and demurrage are taken into account. Containers will remain sealed, and will be exposed to the sun and elements throughout the duration of its journey, meaning contents can be subject to extreme heat or extreme cold.

- **Medical cargo** – Pharmaceuticals and consumables that have expiration dates must be handled with transit times in mind. Many countries won't import medical goods with less than 18 months of shelf life left, a time constraint that starts at the point of customs. This means medical goods must be procured and shipped with even longer shelf lives. Shippers should know the import procedures of the intended destination and plan accordingly. Temperature sensitive items may need reefer storage, even if not expressly stated by the manufacturer.
- **Food stuffs** – Containerised food items should be prepped for long storage – special temperature requirements must be identified up front, and fumigation may be required prior to loading.
- **Dangerous Goods** – Sea shipping standards around dangerous goods are less stringent, but must still be accounted for. Some DG items are reactive to metal, meaning long term exposure to shipping containers might actually damage the container resulting in additional cost to the shipper. Other DG items become combustible with increased heat – even though cargo at origin or destination may not be exposed to extreme temperatures, containers can be offloaded and held in extremely hot climates while waiting transshipping on another vessel. For an overview of the process of shipping dangerous goods by sea, please review the [Dangerous Goods section of this guide](#).

## Planning Sea Movement

In planning movements by sea, port capability and the control of port activity needs to be understood in order to assess any possible constraints that could impede the movement of goods. The following factors will indicate the suitability of a port to handle the planned movements:

- The number, type and size of ships that can be handled at one time.
- Typical vessel waiting and discharge times.
- Availability of equipment to handle different types of consignment – for example, bulk, bagged, loose, containers etc., and its state of repair.
- Availability of labour, working hours and typical discharge rates for both manually.
- Unloaded cargo and containers.

- Operational factors that may constrain activity such as the risk of congestion or the impact of the weather at certain times.
- Port documentation requirements and the efficiency of procedures for clearing cargo.
- Storage facilities and infrastructure such as railways, roads.

Where the movement of goods is to an area under the control of the local public authority, a clear understanding of the requirements covering movement of goods must be obtained from the appropriate authority prior to initiating any movement.

## Road Transport

Road transport is by far the most ubiquitous methods of moving cargo globally. Road transport also happens to be something that individuals or shippers can easily managed directly without having to go through a broker or third party. Trucks and vehicles can frequently be sourced locally, even in the early days of an emergency response, though quality of vehicles and roads may vary.

## Common Terms in Road Transport

<b>Transloading</b>	The act of loading goods directly from one truck to another truck, frequently done at border crossing points or points at which ownership changes hands. Can be used to speed up delivery to final destination.
<b>Tractor</b>	A powered vehicle with a heavy-duty engine specifically designed to pull large loads on trailers. Tractors usually run on diesel fuel, have multi-ratio gears, and come in the form of a large cab.
<b>Trailer</b>	An unpowered, multi axle platform that is pulled by a tractor. Trailers can have many configurations, including being flat surfaces, enclosed, refrigerated, two part (close-coupled) or some variation of therein.
<b>Semi-truck / Tractor Trailer Truck</b>	The combination of a tractor coupled with a trailer, joined with an articulated joint (drawbar) that enables enhanced manoeuvrability.
<b>Single Unit Truck / Straight Truck</b>	A truck where the cab and the truck bed section are permanently connected, and joints are not articulating. The wheels under the bed section can be powered from the main engine giving all-wheel drive and additional grip and handling on the road.
<b>Axle</b>	A rotating shaft that connects wheels on either side of the base of a vehicle. Trucks are often described by the number of axles they have. A higher number of axles may be required for heavier loads or unimproved/off road conditions.

<b>Shunting</b>	Sometimes referred to as "shifting". The act of transporting cargo over short-haul distances between near-by and often predefined locations, such as between a sea port and a warehouse, or within a defined property. Shunting vehicles may require less special equipment and may incur less wear and tear, and often operate in urban environments. Some shunting operations use specially designed tractors to move trailers on to facilitate quick parking, unloading, loading, and staging for departure
<b>Long Haul</b>	The act of moving cargo over long distances, comprising days or weeks and possibly crossing international boundaries. Long haul trucking may require cooking and sleeping amenities for drivers, repair equipment on board at all times, long range communication equipment, and may require off road capabilities.
<b>Lift Gate</b>	A self-powered platform connected to the rear of a truck that will lift pallets/heavy cargo without the need for manual loading. Sometimes also called a "lifting platform."
<b>Intermodal</b>	The act of switching between two modes of transport. In trucking, intermodal frequently refers to the use of shipping containers that can be loaded between different vessels and vehicles as a single unit without having to offload cargo.
<b>Porter</b>	Human, hand loading and offloading. Porters are heavily used in humanitarian contexts.
<b>Bonded Trucking</b>	A truck that is hauling cargo that is yet uncleared through customs into a country. Bonded trucking is highly regulated and comes with additional security precautions that must be complied with. Bonded trucking is typically for short-haul activities, such as moving cargo from an airport to an off side bonded storage facility, but also commonly used while in transit across multiple countries.

## Road Transport Arrangements

### Self-managed Owned or Rented Vehicles

Agencies running operations of any length in any context may wish to buy, rent or lease vehicles that are solely dedicated to and under the management of the agency itself. If an organisation decides to acquire its own vehicles, there are a number of areas to be considered, such as the type of vehicle and body type. The nature of the emergency response operation may also require that mechanical handling aids need to be incorporated into the overall vehicle specification to facilitate loading and offloading. Rented and owned vehicles can be sourced locally, or they can be imported into the response operation at the behest of the organisation. Bringing in outside vehicles might be the best way of finding the best or most appropriate equipment, but may take a long time to acquire and cost a large sum of money depending on the distance to delivery and the type of transport used. Vehicles brought from a different country will also need to undergo regular customs formalities.

Be aware that some countries do not allow particular models to be imported. This is due mainly due environmental or economic reasons. In some cases, countries put extremely high import

and/or registration taxes to protect their manufacturing market. If agencies are looking to import a vehicle, it is of paramount importance to find out the official and practical procedures for import.

#### **Advantages to self-managed vehicles:**

- **Purpose Built** – Rented or owned vehicles can be designed, modified or built specifically to carry a particular product, such as cold chain items, which might require special handling.
- **Self Managed Drivers** – Organisations in total control over their vehicles will be able to train and supply their own drivers, which will allow for development, specialisation and quality control in case of performance issues.
- **Customisation** – Rented or owned vehicle can be outfitted with logos and visibility, and can have customs communications equipment installed and configured.
- **Quality Control** – Using a self-managed vehicle it's much easier to ensure that the vehicle is used in an appropriate and ethical manner befitting of the agency.

#### **Disadvantages to self-managed vehicles:**

- **Time and Complexity** - Self-management of vehicles and fleets can occupy a great deal of time, and require excessive attention from management.
- **Special Knowledge** – Maintaining one or more shipping vehicles requires special skills and knowledge. Unless outside arrangements are made with third party repair services, organisations will have to identify and contract mechanics, and manage their own supply chain of spare parts. Dispatch and fleet management is also its own special skill, and requires knowledgeable and trained staff for coordinating movement of multiple vehicles.
- **Costs** – the start up and investment capital to obtain vehicles, drivers and parts can be substantial, and aid agencies limited to grant funding may not be able to cover costs all at once. Operating in many contexts will also incur substantial insurance costs as well. An owned vehicle must be managed until its property is effectively transferred to another party, including the update of property records by the local authorities. The organisation can be held accountable for any liability related to the vehicle during the ownership period.
- **Single Point of Failure** – Organisations that own or manage their own vehicles run the risk of mechanical issues or an accident completely halting use of that vehicle at any time.

Drivers are an essential component to self-managed trucking fleets, equally as important and the vehicles themselves. Even if an organisation has a perfectly maintained fleet, if they are using poor quality drivers, have drivers who are not licensed to operate in any given context, or don't invest in training drivers, then accidents, damages, cargo loss and possibly issues with fines or law suits may occur. Agencies seeking to maintain their own vehicles and have a staff pool of drivers should ensure that the hiring practice is transparent and skills and knowledge are clearly demonstrated. When recruiting drivers, agencies might consider:

- Asking for documentation to prove authorised license to operate the vehicle in question
- Request a background check
- Ask the applicant to demonstrate their driving skill first hand in a safe location
- Have technical questions prepared
- If possible, enact a drug screening program

## **Third-Party Transport**

Humanitarian organisations have become increasingly reliant on third-party transport



providers as a method of moving cargo into and around response operations. The overall running cost of using third-party companies may be higher, but in the volatile nature of response activities, outside companies can help start operations quickly, and organisations can start or stop operations as quickly as needed without concern for what to do with large physical assets like trucks. Even if an organisation owns its vehicles, there may well be occasions when a need arises for additional capacity to meet peak activity or other short-term needs. This can be met by the use of vehicles supplied by a third-party commercial transport provider.

Third-party transport companies can usually be sourced locally within or near the emergency context, and utilising them also serves the function of putting money into the local economy and fostering local acceptance of the aid agency in question. Organisations should follow all due diligence when soliciting and selecting third-party transport companies, and follow their own internal procurement procedures wherever possible.

#### **Advantages of third-party transport:**

- **Flexibility** - Organisations can use commercial providers to meet fluctuating demand requirements
- **No Size Constraint** - Organisations that may only ship infrequently, or only ship small quantities and may not need self-managed vehicles on hand at all times. Third-party transport caters to variable loads and journeys.
- **Lower Upfront Cost** - Third-party transporters will have virtually no start-up costs, and the transporter may be able to offer a more cost-effective and a more efficient service by sharing loads with other shippers.
- **Reduced Complexity** - The administration of vehicles and drivers is no longer the responsibility of the organisation, allowing the administration teams of the organisation to focus on other areas.
- **Local Knowledge** - Third-party transporters or providers may have better working knowledge of country requirements, local restrictions, geography, vehicle requirements or limitations, optimised routes, sticking points and more.

#### **Disadvantages of third-party transport:**

- **Ethics Concerns** - Third-party transporters don't directly represent a contracting organisation, and as such may engage in activities aid agencies might find unethical, such as transporting equipment for parties to a conflict or employing child labour. Driver standards are also not controlled by the shipper, and activities such as drug use or unsafe driving may occur.
- **Additional Risk** - Though shippers may utilise additional insurance, there is always an increased risk using third-parties who may have less vested interest in the delivery of aid cargo.
- **Higher Long-term Cost** - Though start up costs may be substantially less with third-party transporters, over a long enough period of time and with enough cargo, third-party commercial transport may always be higher per kg. Organisations who are in a long-term programme and ship high volumes of cargo might encounter cheaper costs through renting or owning their own self-managed vehicles.

#### **Considerations for both third-party and self-managed cargo transport:**

Whether the vehicles being used are owned, hired or are managed by a third-party, it is important to ensure that all local laws relating to the licensing, insurance and regulation of vehicles are adhered to:

- Drivers have a legally obtained licence to operate the class of vehicle they are driving on public roads and highways.
- Fees are paid for specific loads such as oversized or hazardous goods.
- Vehicles should be insured to at least the minimum required by law. Different organisations will have internal policies regarding the extent to which their own vehicles should be insured
- Vehicles may also require documentation relating to the maximum permissible weights in terms of gross vehicle weight, axle weight and payload.

## Third-Party Trucking Rates

How third-party trucking companies choose to charge for transport services depends on the country, the context, the anticipated needs of the contract, and even local norms and regulations. Common arrangements:

### Pre-Defined Route

Many trucking providers like to develop contracts based on pre-defined routes. The contract will stipulate a pre-established rate between two locations, expressed as either the cost of the whole vehicle, or as a rate per kg. Pre-defined route based rates are good for agencies that have a known project plan with known and commonly used destinations. Soliciting tenders based on route based rates will help planners easily identify which trucking providers are more cost effective in which areas.

### Time-Bound

In some situations, planners and transporters may wish to specify contracts based on specific time intervals, usually daily or hourly rates. Time-based rates might be useful in the early days of a response, especially daily leasing of trucking services. Time-bound rates may also lead to poor cost controls however - if a vehicle is delayed for whatever reason, renters of the trucking service will be obliged to pay for those days unless otherwise clearly specified in the contract.

### Distance Based

Some contracts are expressed as a rate per distance - usually kilometres - and charge renters of truck service per kg or vehicle. Distance based contracting may be similar to pre-defined routes, however it may be used when planners don't know all final destinations for delivery in advance. Planners should be careful with distance based rates - unless they have detailed knowledge of routes, they may have no way of validating actual distances covered. Planners may also want to implement a vehicle log book to track driver movements.

## Chargeable Weight

In most humanitarian contexts, the only constraints to loading a vehicle are the weight of the cargo, and if the load is oversized. There are some situations in which trucking companies may charge based on what is known as "volumetric weight." Volumetric weight can be applied when cargo is very light compared to its volume. If a humanitarian agency is leasing an entire truck the density of cargo may not be important, however in situations where an agency is being charged per kg, trucking companies may include minimum volumetric weights to help recover operating costs. Planners should assume that light, volumetric cargo may be charged at a different rate.

There is no one universal standard for volumetric weight, however a good indicator of volumetric weight might be:

**Metric ( L (cm) × W (cm) × H (cm) )<sup>3</sup> = Volumetric Weight (KG)**

---

## Unique Concepts to Road Transportation

### Vehicle Selection



It is important to be able to select the appropriate vehicle for the purpose required even if, at a later stage, it is necessary to revise this choice to reflect availability in the field. See below a description of the main body types and combinations that are available.

#### Body and Size

The overall size of the vehicle is largely tied to the load in question. There are many factors that might limit the weight of a vehicle, including local infrastructure, road conditions, local laws and even the overall quality of the vehicle itself.

Often times vehicles are referred to a weight rating, such as a twenty-tonne or forty-tonne vehicle. These tonnages referred to by the vehicle classification are specifying the maximum gross weight of the vehicle, which includes the weight of the cargo and the weight of the vehicle itself. These specific designations are important for route and transport planning, as many roads, surfaces and bridges are rated for different tonnages for a variety of structural or environmental reasons. This means that the actual weight of the cargo payload per vehicle will be moderately less, depending on the vehicle.

The actual maximum allowable payload weight per vehicle will be specified by the manufacturer, and can also be regulated by national or local regulations. The overall body and engine type of the vehicle will also impact the specific maximum payload of the vehicle. For the purposes of planning, the size to payload needs can be defined as in the table below:

Type	Axles	Max Gross Weight (Tonnes)	*Estimated Payload (Tonnes)	Typical Total Body Length (Meters)	Body
Single Unit Truck	2 axles / 4 wheels	3.5	1	Various	
Single Unit Truck	2 axles / 6 wheels	7.5	3.5	Various	

Type	Axles	Max Gross Weight (Tonnes)	*Estimated Payload (Tonnes)	Typical Total Body Length (Meters)	Body
Single Unit Truck	2 axles / 6 wheels	18.8	12	12	
Single Unit Truck	3 axles	26	18	12	
Single Unit Truck	4 axles	36	25	12	
Tractor Trailer Truck	3 axles	26	18	16.5	
Tractor Trailer Truck	4 axles	38	24	16.5	
Tractor Trailer Truck	5 axles	40	24	16.5	
Tractor Trailer Truck	6 axles	41	27	16.5	
Close Coupled Trailer	Various	40	26	18.75	

\*The estimated payload is the weight of goods that can be carried without exceeding the maximum gross vehicle weight. Where law does not specify a maximum gross weight or local circumstances allow, this payload may be increased. For high volume / low weight cargo, the load may reach maximum capacity before weight limits are met.

## Generic Body Types

The desired vehicle body/trailer type will vary according to the goods or materials being carried, the terrain, the distance, and the prevailing security conditions on the ground. There are many variants of body/trailer type available. Generic body types might include:

**Flatbed / Platform** - The simplest and cheapest body type, comprised a flat surface resting on the axles with no sides or protection. Flatbed/platform bodies provide all round access to the load, but offers little security or protection from the weather. Loads carried using the open sided flatbed/platform vehicle will need to be secured using netting/ropes, and will likely need to be covered with plastic or tarpaulin to protect against the elements. Trucks in many humanitarian contexts might use the equivalent of a flatbed truck with built up side walls – this method helps protect against items falling or being taken from the interior of the load, but will still require covering with some form of tarp.



**Box truck / Van body** – A truck body with hard and rigid sides that enclose the platform completely. This body type reduces the payload of the vehicle due to the fact the physical structure adds weight, but provides protection for a perishable product and added security. Construction of the external body will depend upon the needs for insulation, waterproofing or strength. Access is usually provided by a rear door. Sometimes a door will be built into one, or both, of the body sides for special access. Box/van trucks are also ideal for special needs situations, such as refrigerated loads.



**Curtain Side / Drop Side Bodies** - Curtain sided / drop side bodies overcome the disadvantages of access; the full bed can be exposed by either pulling back a curtain or dropping the side of cargo space. This improves the speed of loading as well as unloading. Advantages of load restraint and weather protection are maintained, while body weight might less than the box body. Curtain sided /drop sided bodies are less secure however, as contents are easier to access and cannot always be locked.



**Tankers** - Designed to carry powders or liquids, usually shaped in a way to prevent the vehicle from tipping over due to shifting weight. Tankers require a pumping mechanism and hoses to discharge the load, and some tankers have pumps built right into the back.



**Bulk Carriers** - Built similar box bodies, only without the roof. Bulk carriers are useful for large loads of loose goods that don't require typical manual loading, such as grains, gravel, or even fruits. Bulk carriers might have a mechanical tipping mechanism built right in, otherwise offloading bulk items may be done by hand and very time consuming. Bulk carriers are typically covered with tarp.

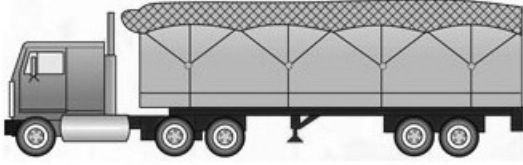

**Double/Close-Coupled Trailer** - a tractor pulling more than one trailer, linked like a chain. A double trailer configuration adds more weight to the load as more axles and connections are required, but adds increased manoeuvrability.



## Vehicle Manoeuvring

Trucks in all of their forms are by their nature difficult to manoeuvre, having special difficulty turning around and backing up. Aid agencies planning cargo operations using trucks must keep the turning and parking needs of vehicles in mind for planning purposes.

When contracting or purchasing trucks for consistent use in or around warehouses, the available parking, loading/offloading and turning space available for the vehicles must be taken into account. Many warehouses have enclosed fencing or walls, and may only have one single entry gate. Any vehicle used for pick-up or delivery must be able to enter the space, turn around and back up if needed. Additional consideration must be taken if multiple truck loads are to be enacted at once - will one truck inside being loaded/offloaded prevent another truck from entering, leaving or manoeuvring?

Long haul vehicle movements may be along narrow roads with no shoulders, cross roads or turn around space. An especially long truck may not be able to turn around if needed while en-route, and may need to reach its destination or next large intersection, which may be hours or days away.

At any time and regardless of the terrain, persons operating trucks must remain aware of height and width limitations of tunnels, underpasses, alleyways and enclosed parking areas, and must remain aware of weight limitations of bridges. When evaluating the size and weight limitations of vehicles, operators must also take the size and weight of cargo into account as well. A vehicle may be able to operate along a regular route under normal conditions, however an oversized cargo load may impact operating conditions.

Below is a general guide for vehicle turning radius. Planners should note that actual turning radius depends on the vehicle, and different makes and models will have some differences.

**Single Unit Truck Body:**

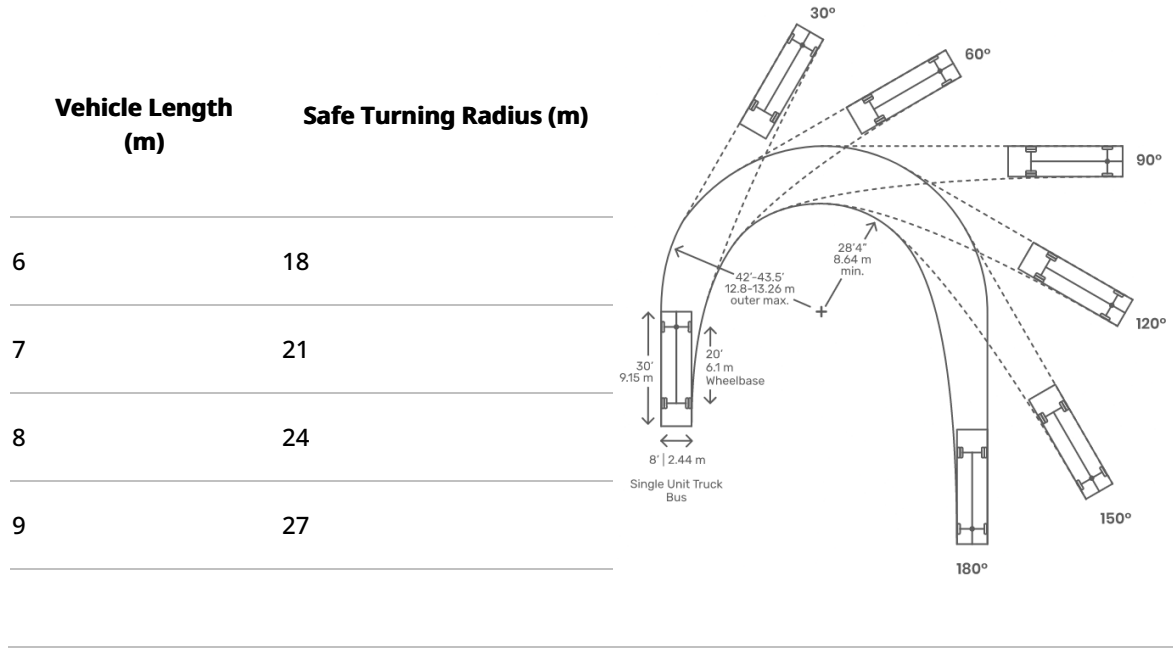

**Articulating Tractor Trailer:**

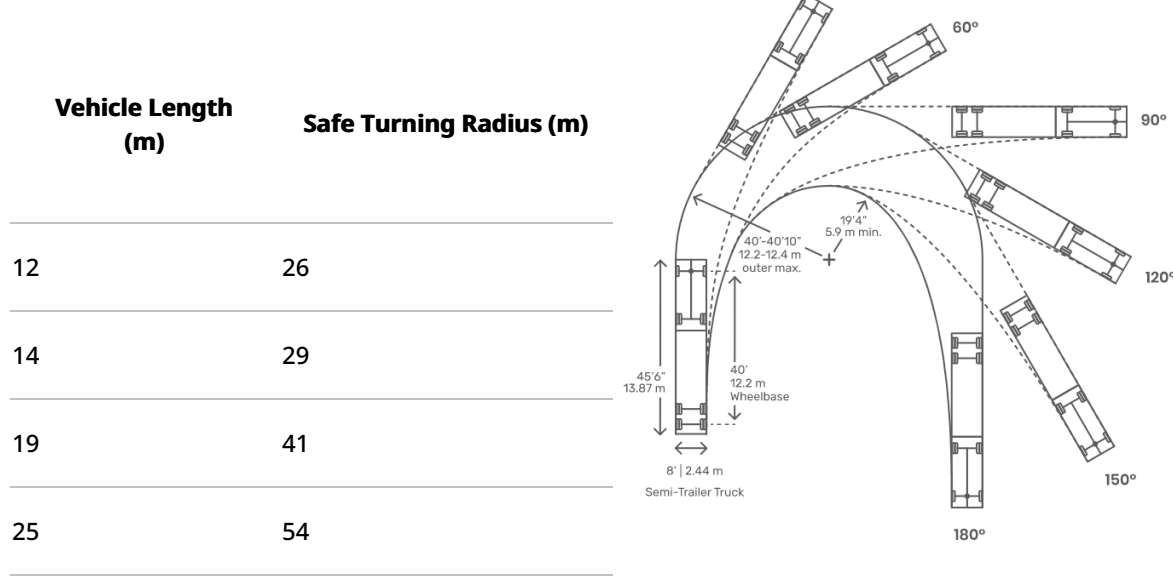

A quick reference guide to vehicle body types and vehicle manoeuvring can be [downloaded here](#).

**Sending Goods by Road**

**Road Transport Documentation**

There is no universal standard to documentation used for cargo shipped by road.

**Domestic truck movement** - In the majority of situations in which aid agencies operate, most cargo movement on roads operates domestically, which doesn't require international customs

clearance. Domestic cargo movement can be tracked in variety of ways, but the most common is a waybill. Many third-party transporters can use their own waybills, however agencies may wish to utilise waybills in their own formats. Organisation specific waybills tend to take specific needs into account, such as accounting for metric tonnage or tracking based on batch/lot number of medication, things which may not be tracked in the waybill provided by a transport company. Shippers are encouraged to use the [standard set of shipping documents](#) for all domestic movement.

**International Truck Movement** – Many countries globally recognise what is called a “CMR” international waybill. The CMR was proposed and agreed upon under the [United Nations CMR Convention of 1956](#), and subsequently adopted by the [International Road Transport Union](#). The CMR functions similar to an Airway Bill (AWB) or Bill of Lading (BOL) in that it is a standard and uniformly recognised document for the transport of goods between two countries. Where formally recognised, CMRs are also part of the formal customs process and are asked for by customs officials, and designates roles and responsibilities of parties. The CMR does not take the place of a regular waybill – all traditional documentation may be still be required, and formal customs procedures for importation must be respected – but the CMR standardises the language for authorities to understand the nature of goods either being imported into a country, or across a country. It is important to note that the CMR is not recognised everywhere in the world, there are currently only 45 countries who recognise the CMR, consisting mostly in Europe, the Middle East and Central Asia.

Example CMR:



**LETTRE DE VOITURE INTERNATIONALE**

**CMR**

**INTERNATIONAL CONSIGNMENT NOTE**

**SF**

COPY 1 SENDER  
COPY 2 CONSIGNEE  
COPY 3 CARRIER

2  
GOODS FOR  
HAZARDOUS  
INDICATE  
1. UN NUMBER  
2. PROPER  
SHIPPING  
NAME  
3. HAZARD  
CLASS  
4. PACKING  
GROUP  
5. OTHER  
CONTENTS  
6. ADR 191  
7. RID

Approved by FT/AF/HA/SIT/PHO UK 1981

46020000 611700 250000 072000

Sender (Name, Address, Country) Expéditeur (Nom, Adresse, Pays)		1	Customs Reference/Status Référence/designation pour mise en douane		2
			Senders/Agents Reference Référence de l'expéditeur/de l'agent		3
Consignee (Name, Address, Country) Destinaire (Nom, Adresse, Pays)		4	Carrier (Name, Address, Country) Transporteur (Nom, Adresse, Pays)		5
Place & date of taking over the goods (place, country, date) Lieu et date de la prise en charge des marchandises (Lieu, pays, date)		6	Successive Carriers Transporteurs successifs		7
Place designated for delivery of goods (place, country) Lieu prévu pour la livraison des marchandises (lieu, pays)		8	This carriage is subject, notwithstanding any clause to the contrary to the Convention on the Contract for the International Carriage of Goods by Road (CMR) Ce transport est soumis nonobstant toute clause contraire à la Convention Relative au Contrat de Transport International de Marchandises par Route (CMR)		
Marks & Nos; No. & Kind of Packages; Description of Goods* Marques et Nos, No et nature des colis, Designation des marchandises*		9	Gross weight (kg) Poids Brut (kg)	10	Volume (m³) Cubage (m³)
					11
Carriage Charges Prix de transport		12	Senders Instructions for Customs, etc... Instructions de l'Expéditeur (optional)		13
Reservations Réserves		14	Document attached Documents Annexés (optional)		15
			Special agreements Conventions particulières (optional)		16
Goods Received/Merchandises Rescues		17	Signature of Carrier/Signature du transporteur	18	Company completing this note Société émettrice
			Place and Date; Signature Lieu et date; Signature		20

FORM REF: 730 CMR

A map of countries that currently recognize and use the CMR in some format:



Source: [Wikipedia](#)

Countries who don't currently utilise the CMR will have their own means of importing cargo, depending on national laws and regional trade arrangements. Prior to importing goods to any country of operation through road transport, shippers and consignees must investigate the import and export laws for both countries.

Unlike air and sea freight which can pass over or around countries relatively unnoticed, many international shipments using trucking will be required to pass through the territory of one or more additional countries to reach their destination. In order to facilitate this process, vehicles may have to travel with what is called a "through bill of lading." The through bill of lading should contain the relevant information required by the countries through which the vehicle is passing. Vehicles transiting through third-countries may also be subject to enhance scrutiny and inspection, or be required to take additional security protocols to ensure cargo does not enter the local market without undergoing customs. In some cases, banned substances will not be allowed to pass through a country's national borders at all, even if the final destination is another country.

Occasionally, national laws and the policies of individual transport companies prohibit trucks from crossing borders all together. To mitigate this problem, many states of adopted pre-defined transshipping points at specific places along their borders. At these points, cargo can be offloaded and placed in temporary storage, or even transloaded directly to another vehicle. When this border transshipment occurs, all relevant documentation will still travel with the cargo.

## **Route Planning and Scheduling**

Route planning is the process of planning the movement of a particular quantity of goods in vehicles of known capacity. It assumes that goods are supplied from a fixed depot or starting point and that the location of individual customers is known. It recognises that restrictions on vehicle operations do occur, due to such factors as constraints on working hours, safety and security constraints, the total length of daily travel possible and the volume that can be moved within a normal working day. An acceptable solution to the route planning and vehicle-scheduling challenge should provide optimum routes that satisfy the demands of the work load, take account of legal requirements and reflect the efficient and cost effective use of the operator's resources.

A satisfactory solution should provide a schedule of routes that minimise either total distance or time travelled by vehicles. Route planning involves an assessing all possible routes, applying the following operational conditions:

- The number of calls to a particular delivery point in any single day is limited.
- The total vehicle travel in any day is limited and the driver's time is limited.
- Vehicles have a fixed carrying capacity.
- Whether the roads are suitable for the specific transport needs and vehicle, including road conditions, hairpin turns, and any narrow gates or physical structures.
- Volume of goods for each delivery point is known and each drop has a location for which there is an established driving time to and from the warehouse or to the next delivery point.
- The quantity of goods delivered to any drop is smaller than the vehicle's carrying capacity and there is an established time to deliver/collect at the drop point.
- The operating hours of the delivery/offloading points are known, and constraints such as peak hours are understood.

### Calculating a Route Plan

A vehicle route is scheduled by basic following steps:

- Establish the time it takes for a vehicle to travel from the origin to a delivery point, adding the time taken to offload at the delivery point, assuming the vehicle is not over capacity or operating at unsafe speeds.
- Establish geographic proximity from the first delivery point to the second (if more than one delivery), counting total time to arrive and any offloading time, also assuming the vehicle is not overloaded or travelling at unsafe speeds.
- Repeat for all desired delivery points.

Continue this set of assumptions for all delivery points needed – once the theoretical vehicle is either too full to carry all deliveries, or the vehicle cannot complete all deliveries during safe and normal hours of operation, then you have established a route plan that fully utilises the available driver's time or the vehicle capacity. Repeat this step for as many vehicles until all orders are allocated or all available vehicles are fully loaded. When calculating the driving time it is important to use an average speed relative to the vehicle type, quality and condition of the roads, and prevailing weather conditions allowing for such things as delays at junctions, hills and urban congestion. In practice, average speed will be considerably less than the maximum permitted speed for a road.

The nature of the movement can be split into two basic types:

- **Primary Movement** - Involve typically bulk movements between two specific locations. This may be between two warehouses in a network or from a port or rail-head to a warehouse.
- **Secondary Distribution** - Movements that may involve multiple deliveries within a defined area, such as a regional or local warehouse to extended delivery points.

In both cases, the emphasis is on achieving full utilisation of the resources used - filling the vehicle to capacity minimising the distance travelled and optimising the hours which the driver is being paid to work.

### Safety and Security

There are a number of safety considerations when planning and managing road cargo, these

might include:

**Load Securing** – Ideally, cargo will be properly secured. A secured load does not just mean sealed to prevent theft, but also to prevent cargo from falling off, or worse, vehicles tipping over and causing accidents. Hard sided box trucks should be properly locked, while intermodal containers may be officially sealed depending on the delivery terms. Cargo stored on flat bed trucks or trailer should be properly tied down and covered. At minimum, cargo should not move around inside or on the truck surface as the vehicle moves, and there should be no spillage or falling items on the road causing hazards for people and other drivers. Local regulations might also govern things such as the vehicle weight, the way it is loaded and how the load is distributed.

**Loader/Porter Safety** - The process of loading and offloading trucks can be very dangerous. Flatbed, box or drop side vehicles may be loaded with the assistance of machinery such as forklifts or small cranes, both of which may move excessively heavy loads that can fall and injure bystanders. The area around trucks loaded with MHE should be cleared of unnecessary personnel, and any designated persons should be clearly marked with high visibility vests.

In humanitarian field settings, vehicles are often loaded by hand, frequently by low skilled labour. Porters should be able to safely and ergonomically load cargo onto vehicles:

- Porters should not carry cargo of excessive bulkiness or weight.
- If the loading point does not have a drive up loading bay, porters should be able to safely step up and down from the vehicle bed without jumping or climbing.
- Porters should only be expected to load for reasonable amounts of time, with breaks in between. Ideally loading teams would be split; 2-4 loaders on the truck and the necessary number of loaders carrying goods to and from the warehouse/depot/discharge point, reducing the need to enter or exit the vehicle.
- Porters should be monitored for unsafe behaviour or possible security concerns.

**Road Conditions** – In many humanitarian contexts, road conditions are extremely poor. Vehicles should be well maintained as possible, and drivers should not take unnecessary risks. Trucking on poor road conditions such as mud, loose soil or standing water can be augmented by the use of 6x6 trucks (3 axle vehicles will all wheel drive) or any vehicle with a drive shaft that powers the rear axles. Drivers should also understand the route, and have some experience navigating adverse driving conditions.

**Infrastructure** – In the immediate aftermath of a rapid onset emergency, or as a result of armed conflict, infrastructure such as roads and bridges may be fully or partially damaged. Routes that may have been previously accessible may be inaccessible. Third-party transport companies and hired drivers should exercise caution around damaged infrastructure.

**Transporting Dangerous Goods** - Vehicles transporting any amount of dangerous goods (DG) for any reason should reference guidance on the [road transport of DG](#) in the Dangerous Goods section of this guide.

**Vehicle Marking** – Depending on the context, there may be national and local laws that require vehicles containing specialty items such as livestock or any form of DG items to be properly labelled and marked while on the road.

**Driver Behaviour** – Drivers and operators of vehicles are responsible for using a vehicle on the road with a safe and secure load. Local laws will often state that the drivers in transit have full responsibility for the safety of their load, even if they did not load it personally. Even in countries or local contexts where such laws are present but are not implemented, respected or

followed, every effort must be made to ensure that the organisation's drivers are following the regulations that have been established. Most humanitarian organisations also have their own safety and security policies that need to be followed.

**In-transit Theft** – The main sources of vehicle theft are from depots, from overnight parking areas and from the roadside. Theft can be committed by stealing an unattended vehicle, forcibly hi-jacking a vehicle, or bribing drivers. Drivers are central to prevention of this type of loss, and their integrity is essential. Consequently, careful recruitment and selection of drivers is critical. Training will impress upon them the need for care, and procedures to follow to avoid risk of theft. Driver identification cards can be used for added security and to avoid thieves gaining access to vehicles by misrepresentation when parked on third party premises. However, there is little to prevent deliberate collusion by drivers. Vigilance is essential and attention to any pattern of discrepancies on loads. A thief intending to steal a loaded vehicle benefits from:

- Knowledge of an attractive load.
- The opportunity to access it.
- Time to steal it and to get away before detection.
- A market for the goods.
- Limited or negligible perception of risk.

## Vehicle Recovery

In the process of movement by vehicles in austere working conditions, vehicles can and will break down, become stuck, or otherwise be immobilised. Understanding the types of equipment and techniques used to recover vehicles is important to drivers and persons planning routes, while knowing the route and type of vehicle in use will help inform the type of recovery tools. Some recovery tools are extremely dangerous when in use, and should be operated only by knowledgeable persons with proper training! Some of the below recovery items are useful for recovering light vehicles only. Heavy vehicles exceeding 7-10 ton capacity may require additional special assistance.

**Scissor/Bottle Jack** – Scissor or bottle jacks are regular vehicle jacks that might be part of the standard package of tools that new cars come with. Scissor or bottle jacks are useful for changing single tires, but are really only best suited for flat, stable road conditions. Scissor/bottle jacks may not work well in mud, and can really only be used to elevate the vehicle enough to change a single tire. On non-paved roads, they may require a solid object underneath them to distribute the weight, such as a flat rock or a strong board. Scissor/Bottle jacks should only be used on the appropriate contact points to avoid causing damage to the vehicle.

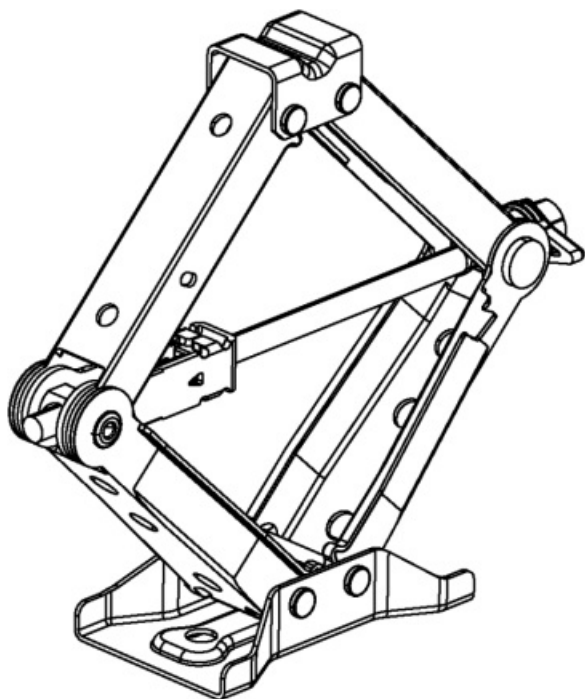

**High-lift Jack** – High-lift jacks are far more robust than scissor/bottle jacks. They can be used to lift vehicles out of mud, or raise vehicles enough to place braces or other objects underneath them. When a vehicle is full lifted, a supporting high-lift jack can have enormous pressure on it; the jack handle if not properly secured can cause bodily harm, and the jack itself may collapse with the full weight of the elevated vehicle. High-lift jacks should only be used on the appropriate contact points to avoid causing damage to the vehicle.

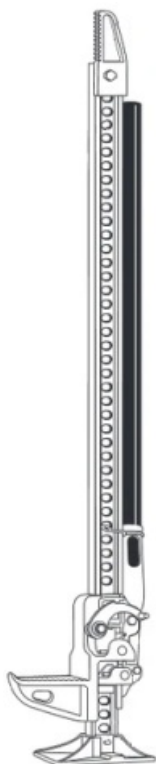

**Recovery Winch** – Recovery winches are powered electric motors that can retract rope or metal

cable. Many field level vehicles have winches permanently attached to the vehicle, usually on the front bumpers. Winches usually draw their power from the electric battery of the vehicle, and are capable of supporting the weight of the vehicle itself. Winches should only be attached to objects and anchor points that can physically support the weight of the vehicle and withstand the horizontal pressure applied by the winch. When a winch is being used, all persons should be inside a vehicle, have proper cover or be a safe distance away.

Winches are useful for pulling vehicles stuck in mud, or are otherwise immobilised on an incline. Because winches are made to support the full weight of a vehicle, the cables or ropes can be very dangerous under full pressure. Additionally, improper use of a winch may cause damage to vegetation or nearby structures. Sometimes, vehicles with winches utilise what are called "snatch blocks" or "winch blocks" – pulleys that are designed to change the direct anchor point of a winch when a clean anchor isn't available.

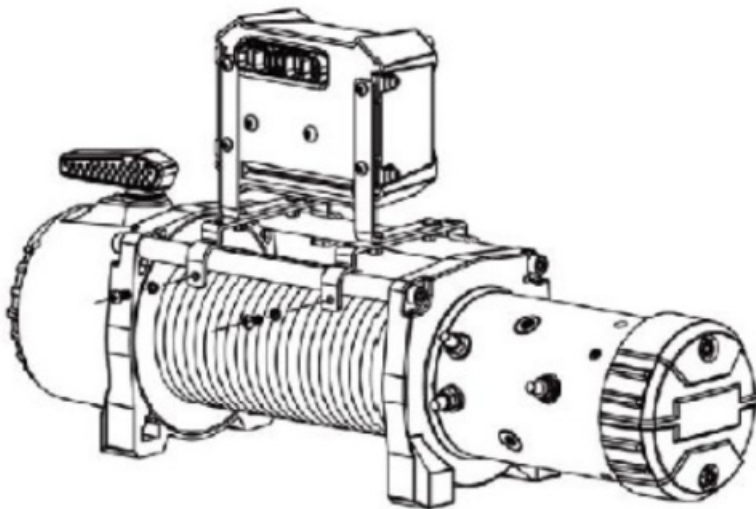

**Snatch Straps** – Snatch straps are bands made of durable synthetic material that are designed for one vehicle to pull another vehicle. Snatch straps should be strong enough to support the weight of the vehicle being towed, with some additional tension caused by momentary velocity differences between the vehicle being towed and the vehicle pulling. Snatch straps should only be used in a slow-speed, and only in a recovery capacity. Much like the winching, snatch straps should only be in use when all persons are at a safe distance.



Other tools that may be useful for vehicle of all size include:

- Tire irons
- Full sized spare tires
- External air compressors
- First aid kits
- Jumper cables

## **Cargo Configuration for Road Shipping**

### **Loading Vehicles**

Unlike sea or air cargo transportation, humanitarian actors will almost certainly be involved with the direct loading of cargo vehicles at some point. Loading of cargo onto a truck may appear fairly straight forward, however there are several things that shippers may need to consider. Frequently, third-party transport companies and private vehicle hires may understand the loading needs of their own vehicles, but in the event agencies are self-managing loading or the third-party service does not have the capacity to manage loading, organisations may have to - and possibly be legally required to - take responsibility for securely loading vehicles.

The overall balance of the load on the bed or cargo hold of any truck varies based on the body, while the overall weight limits of each of the vehicles varies based on the vehicle itself - prior to planning a cargo load, it is strongly advised to research the type of vehicle to avoid accidents.

Single unit or conventional trucks are designed to carry 70-80% of cargo weight over the rear axle, balancing the load of the cargo against the weight of the cab.



### Cab Over Engine Truck

### Conventional Truck

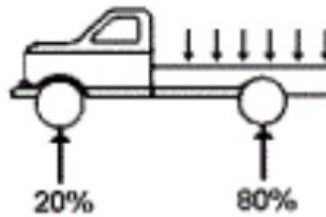
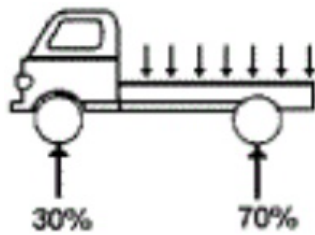

When loading cab over engine or conventional pickup trucks with heavy cargo loads, start above the rear axle with weight distributed just before the axle towards the centre of the bed. Loads pushed too close to the cab can obscure the rear view of the driver, will increase the distance required to break, and may reduce traction to the road due to uneven weight distribution. Loads pushed too far to the rear will be more unstable and can also cause problems with traction. Loads sticking far off the rear of a smaller truck should be avoided whenever possible – excessively long loads not only cause weight imbalance to the vehicle, but may be hazardous to other vehicles and passengers.

### Correct Loading

### Incorrect Loading

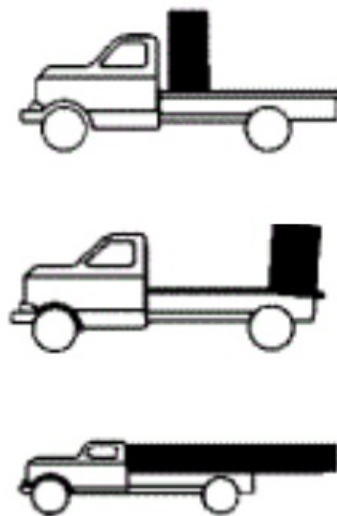
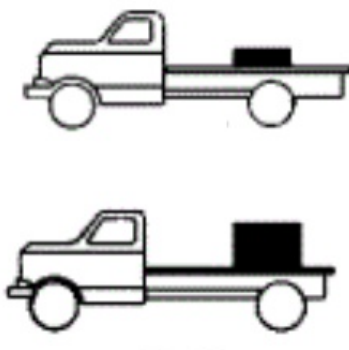

Tractor / trailer configuration trucks are designed to keep cargo weight centred between the two axles. When loaded to a tractor weight should be evenly distributed in the centre of the bed, while trailers without a truck may be loaded with weight slightly moved towards the rear axle.

## Trailer and Tractor Trailer Truck

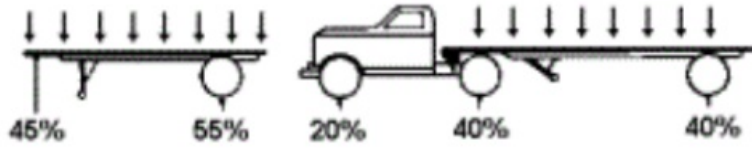

When planning a load on a trailer, consider the "X" planning strategy - if a line is drawn between each of the wheels where they make contact with the road, where the two lines intersect to form an "X" is where the centre of gravity for any cargo load should go.

"X" configuration:

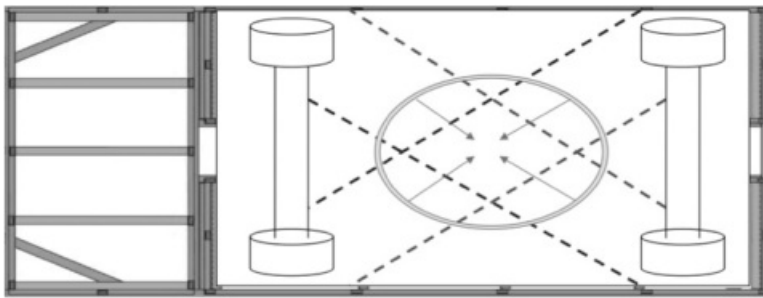

**Correct Loading**

**Incorrect Loading**

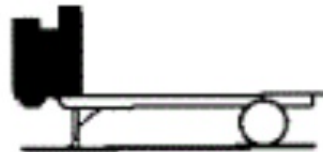

When loading all vehicle types, ensure that cargo weight is also centred in along the short edge of the bed as well. Cargo weight too far to one side or another can lead to instability in the

vehicle, impacting turning or even leading to vehicles tipping over.

### Correct Loading



### Incorrect Loading



In all loading configurations, planners and loaders should consider:

- Always load the heaviest items at the bottom of the items stacked onto a truck bed. Top heavy loads are more likely to fall over in transit.
- Loaders should plan for weight to be evenly distributed on all four sides of a truck bed. Even if space is properly utilised, overly heavy cargo on one side of the vehicle will cause issues while in transit.

## Weight in Movement

Cargo on the back of a vehicle can be heavy or bulky, and while drivers may understand the overall weight of the vehicle while stopped or at low speeds, increased speed can cause the weight of the cargo to act on the vehicle in unintended ways. Forces acting on the cargo during transport are caused by different movements made by the vehicle. The acting forces are:

- Deceleration
- Acceleration
- Centrifugal force (outward)
- Gravity
- Vibration

These forces may cause sliding, tipping and wandering. Cargo loads should always be properly secured, and vehicles should take extra caution when going around corners, going over bumps or small hills, or when starting or stopping.

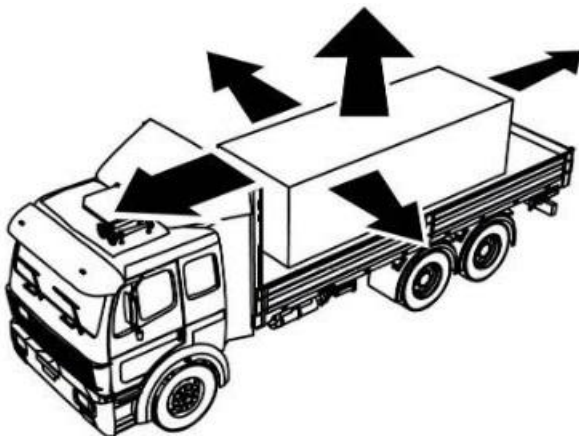

## Cargo Tie-Downs

Any place where a rope or chain passed over cargo and is secured to both sides of the vehicle is referred to as tie-down.

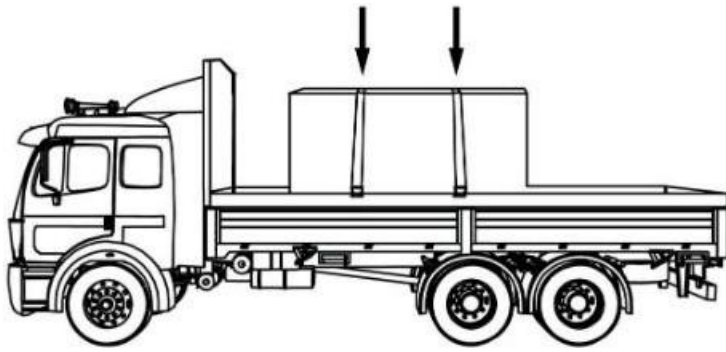

A general guide for how many tie-downs to use can be seen below:

<b>Number of Tie-Downs</b>	<b>Length of Load</b>	<b>Weight of Load</b>
<b>1</b>	Shorter than 1.5 meters	Less than 500 kg
<b>2</b>	Shorter than 1.5 meters	Greater than 500 kg
<b>2</b>	Longer than 1.5 meters but shorter than 3 meters	-
<b>3</b>	Longer than 3 meters but shorter than 6 meters	-
<b>4</b>	Longer than 6 meters but shorter than 9 meters	-
<b>4 (at least)</b>	-	Greater than 4,500
<b>5+</b>	Additional tie-down for every additional 3 meters gained after 9 meters	

Typical loads of cartons and basic relief supplies can be secured using nylon rope, however extremely heavy equipment such as generators or vehicle should be secured using chains. The best way to gauge the strength of a series of chain tie downs to secure a load is what is known as the “working load limit” (WLL). WLL is measured by combining the WLL of each individual chain or rope used as a tie down. As an example, if a load is secured with four chains with a WLL each of 500 kgs, the TOTAL WLL for that load is 2,000 kgs.

To properly design a WLL for transport of heavy or bulky cargo, the total WLL of all tie-downs should be at least half the weight of the load itself. As an example, if a truck is transporting a generator that weighs 3,000 kgs, the combined WLL of all the securing chains should be at least 1,500 kgs. The WLL on the tie-downs accommodates for shifts in weight as the truck turns, stops or accelerates, shifting the centre of gravity of the heavy load.

Chains are measured in both their size and their grade:

- Size - The diameter of the metal "wire" in the link.
- Grade - The stress a chain is designed to break at.

A general guide to WLL per chain type can be seen below.

**Working Load Limit (WLL) in Kilograms (kgs) per Grade and Chain Size**

Chain Size (cm)	Grade 30	Grade 43	Grade 70	Grade 80	Grade 100
0.6	500	1,100	1,400	1,500	1,850
0.8	900	1,800	2,200	2,100	2,600
0.95	1,200	2,550	3,000	3,200	4,000
1.1	1,600	3,200	3,900	-	-
1.25	1,900	4,000	5,000	5,400	6,700
1.6	3,150	5,900	7,200	8,250	10,300

Whether shipping cartons or oversized bulky items, there are recognised loading and securing methods to minimise accidents and damage to cargo.

**Cartons / sacks** – when loading cartons or sacks into the bed of a truck, avoid stacking in pyramid or forming piles. Cartons and sacks should be stacked in even rows, as low to the bed of the truck as possible. Stacks should be arranged in [interlocking "brick" format](#) to avoid stacks from coming apart, and where possible, stacks of cartons or sacks should be secured with netting, tarp or rope, especially if the truck bed has no sides or bars.

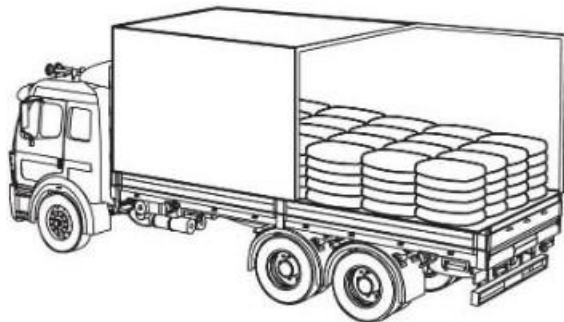

**Bulky items** – bulky items such as timber, generators, or other large equipment should be firmly secured to bed of a truck using rope or chain of appropriate strength.

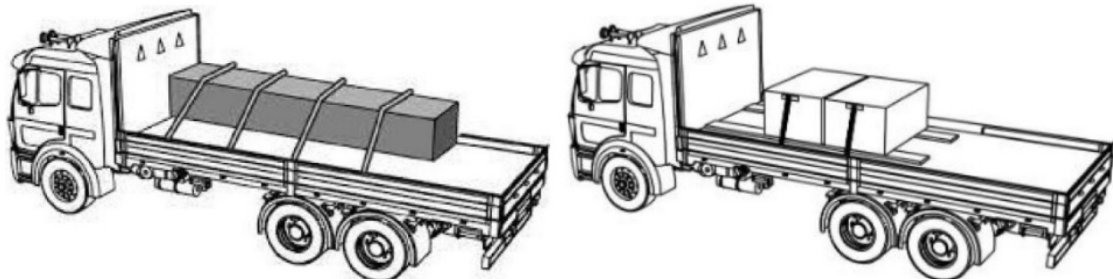



---

A quick reference guide to cargo load securing can be [downloaded here](#).

## **Contracting Third-Party Transport**

### **Recommended Terms - All Movements**

If humanitarian organisations plan to solicit and contract third-party transport services, below is a general guide to terms and conditions that planners may wish to consider.

- The contracted trucking company should ensure that drivers fill in all required information on provided logbooks or activities sheets as instructed and agreed with the contracting agency.
- It is recommended that the contracted trucking company should ensure a proper and adequate [vehicle inspection checklist](#) is completed daily.
- The contracted trucking company should ensure all trucks have adequate lashing or tie down equipment, and all required handling equipment.
- The contracted trucking company should ensure that all drivers wear safety equipment present in the truck for driver use as and when required.
- It is recommended that humanitarian agencies require contracted trucking companies to use [logbooks](#), activity sheets and [vehicle inspection checklists](#), maintained for all drivers / equipment for quality assurance purposes. Contracting humanitarian agencies should inspect logbooks and activity sheets on a routine basis.
- Where possible, drivers should be reachable during the whole transportation time by the contracted trucking company and contracting humanitarian agency whenever needed.

### **Driver Training**

- The contracted trucking company should ensure the driver used for transporting humanitarian goods is well trained, and training can be demonstrated to contracting humanitarian agencies upon request.
- The contracted transport company should ensure that the drivers used for delivering pharmaceuticals or other temperature sensitive goods are trained well and are aware of the temperature requirement of the goods being carried.
- The contracted transport company should ensure that the drivers used for delivery dangerous goods are well trained on handling and transport of dangerous items, and in compliance with national and local laws and regulations.

### **Contracted Trucking Company Responsibilities**

- If any truck is subcontracted by contracted trucking company, the subcontracted vehicle is the contracted trucking company's sole responsibility and should ensure the subcontractors comply with the conditions agreed between the humanitarian organisation & contracted trucking company.
- The contracted trucking company is responsible for ensuring that all cargo is delivered within the agreed transit time period.
- The contracted trucking company should ensure the drivers reach the correct point of delivery and the proof of delivery has to be signed and stamped by the consignee.
- The contracted trucking company should ensure to handover of cargos at point of delivery.
- The contracted trucking company should submit invoice, and receipts to the contracting humanitarian agency within the pre-defined contracted period after delivery.

## **Reports and Communications**

- The contracted trucking company should clearly communicate the daily transportation requirements.
- The contracted trucking company should ensure that if drivers are not reachable, a status update report can be sent once the drivers are contacted. Update reports should be sent at a pre-defined period, established in the contract.
- The driver used for any transport should report any instance of the following within a contractually pre-defined period:
  - Accident, theft, or damage at any point during the transportation.
  - Security incidents, including checkpoints, detention, armed conflict on the road, harassment from security officials or any other security relate matter.
  - Physical impediments including damaged infrastructure, road closures, impassable weather conditions, or anything else that may prevent vehicle movement.
- Any additional charges billed without transport supervisor / manager awareness should not be accepted and should be removed from any invoice or 'statement of account' of the contracted trucking company.
- The contracted trucking company should promptly inform the contracting humanitarian agency via phone or email in any case of discrepancy at the destination offloading point, such as short shipment, damages, theft, temperature variances or any other problem related to delays in delivering the cargo to the point of delivery.

## **Insurance and Limitations of Liabilities**

- The replacement costs of lost or damage of transported items due to negligence should be the responsibility of the contracted transport company, and all repayment terms and deadlines should be included in the contract between parties.
- The contracted trucking company should indemnify the contracting humanitarian organisation, its affiliates and its and its and their officers, and employees from and against all claims, liabilities, damages, and expenses arising out of or incidental to the performance of the services, for:
  - Any and all injuries to or death or illnesses of any person.
  - Any and all damage to or loss of property.
  - Any and all damage to or loss of humanitarian organisation's goods under the sole care, custody and control of contracted trucking company in the performance of the services.
  - Any and all breaches of applicable laws and regulations, except in cases of gross negligence or wilful misconduct of the contracting humanitarian organisation.
- It is strongly recommended that the contracted trucking company should be obliged to

take out and maintain, in its own name and at its own expense insurance adequate to cover its liabilities in full force and effect at all times during the contracted transport process:

- Liability insurance policy to cover any and all shortages, damages, pilferage, missing, misallocation or any other loss of the goods while in the contracted trucking company's care, custody or control subject to a maximum liability of an adequate amount to compensate the contracting humanitarian agency against any loss or goods damage in accordance to the applicable local laws and regulations; whichever is higher.
- Motor third party liability insurance, with minimum compensation limits for bodily injury, death or property damage in accordance to local applicable law and regulations
- All insurance policies effected by the contracted trucking company should contain the provision that they cannot not be amended, deleted or permitted to lapse without the express prior approval of the contracted company.
- Deductibles under the insurances maintained by the contracted trucking company or its subcontractor should be the responsibility of contracted trucking company's or its subcontractor's.

## **Recommended Terms - Temperature Controlled Movements / Requirements**

For more information on contracting third party transporters to move temperature regulated medical cargo, please reference the [health supply chain](#) section of this guide.

## **Organising Humanitarian Convoys**

In the course of humanitarian operations, humanitarian aid agencies may need to organise convoys for the proper delivery of relief items. The need to organise a convoy may be very contextually dependent - in well developed markets with high degrees of road safety and predictability, there may be no reason to use convoys at all. The use of convoys is usually based upon the insecurity of the operating environment, the uncertainty of the road conditions, the absence of persistent communications along the route, the value of the cargo, or any combination therein. General guidelines for organising convoys may be as follows:

### **Operational Basics**

- Though the decision is ultimately up to each humanitarian organisation's management, it is strongly advisable that vehicles should not be part of military convoys, or even civilian humanitarian convoys with armed escorts.
- Radio/telephone/communications contact should be kept between at least the vehicle at the back of the convoy and the leader.
- Where possible, vehicles should carry communications equipment capable of reaching a location or focal point in a different location.
- Planned convoy dates and contents should not be shared widely, or with unauthorised parties.
- Local communities, police, military or governments may have procedures for organising convoys, or for passing through specific areas. Humanitarian organisations should liaise with proper authority figures before moving through unknown areas.
- Humanitarian agencies may choose to operate their own convoys, or collaborate to form joint convoys. If more than one organisation is participating in a convoy, all parties should



agree to and understand on rules in advance, and even develop written agreements in necessary.

- Agencies may use commercial vehicles, or they may utilise their own leased/owned vehicles. The policies and rules in place for convoys should reflect the transport arrangement. If commercial transporters are used in a convoy, terms of the convoy may need to be written into transporter contracts.
- The person/team on the receiving end of a convoy should ideally be informed in advance of what the anticipated cargo is, and if possible should receive an advanced copy of the packing list, and receive estimated dates/times of arrival. All cargo should be counted - and if required weighed/measured - at the receiving end to ensure no cargo has gone missing along the way.

In the event of a cross-border operation:

- All customs related documentation should be identified and provided in advance to the driver, convoy leader, and intended recipient.
- A trustworthy person from the organising humanitarian agency should inspect cargo and vehicles both prior to arriving and the border crossing and after goods are cleared to ensure that cargo has not been tampered with and avoid accusation of smuggling.
- If cargo is offloaded and transloaded onto new vehicles, a representative from the organising humanitarian agency should be present to observe the process. Ideally, cargo should be counted after the transloading is complete to ensure that no theft or loss has occurred.
- Organisers should plan for border crossing times.
  - Vehicles may wait for days or even weeks at border crossings in some cases. Drivers must have the ability to eat and sleep safely while still maintaining physical presence around cargo vehicles.
  - Ideally, vehicles should be able to return safely in daylight hours if rejected at the border.
  - Any and all delays or problems associated with customs or border crossing should be communicated to the appointed organising focal point as soon as possible.

## **Convoy Organisers**

It is strongly advised that convoy organisers should:

- Appoint a convoy leader with experience and knowledge of the route.
- Where possible, plan the route carefully in advance with designated stopping places.
- Generate and provide all required documentation, including waybills and packing lists.
- Decide beforehand what procedures to follow if the convoy is obstructed or blocked, and brief all drivers fully before starting movement.
- Identify a security focal point and/or organiser outside the convoy who will be on call during convoy.
- Conduct detailed briefings with transporters/drivers.
- Ensure they have driver names, contact details, and vehicle plate/registration numbers prior to departure.
- Maintain communication with convoy leaders at pre-determined intervals where possible.
- Following each trip, record any security intendents or checkpoints for future planning.
- Develop a repair and recovery plan (spare parts, a chase vehicle, easy access to a recovery vehicle, etc.).
- Recover visibility items once the mission has been completed, especially in cases where commercial vehicles are in use.

## Convoy Vehicles

Before a convoy departs, it is strongly advised that vehicles should:

- Be in a good mechanical condition. Organisations and planners should check for significant wear and tear, tyre pressure, etc.
- Travel with a full complement of spare parts (filters, belts, spare tires, motor oil, etc.) wherever possible.
- Where necessary, be well branded with their organisation logos. It is suggested to use at least one of the following items: flags, banners or large stickers.
- Be fully fuelled and ready to depart upon reaching the assembly point.
- It is strongly advised that vehicles have an alternate driver. The driver's alternate should be legally able to drive, and have experience with long-haul trucking.

During a convoy, it is strongly advised vehicles should:

- Obey speed limits, and drive only as fast as conditions permit.
- Obey all local and national rules and regulations.
- Maintain a steady speed.
- Not overtake other vehicles within the convoy.
- If required, use flags to distinguish the first and last vehicle of each section.
- Maintain a constant distance between each other. The recommended distance is 100 meters in day, 50 at night, however distance between vehicles will depend on terrain, the speed required, visibility, and other limiting conditions.
- Not transport any cargo that is not contained on the associated waybills/packing lists, not part of the originally delivery plan, and that is not intended for humanitarian use.
- Where avoidable, not move in convoy before sunrise and/or after sunset.
- Abandon the convoy or leave any truck behind without instruction from the convoy leader or authorised person.
- Not pick up hitch hikers or other persons not originally in the convoy plan. Vehicles should be especially warned against transporting soldiers or non-state armed actors under any circumstances.

In the event a vehicle breaks down while in transit:

- All convoy vehicles must stop. The convoy leader should contact the designated organiser and security focal point.
- Convoys should resume only after it is determined that a repair/recovery effort is underway, or if the security focal point determines that it is safe to leave a vehicle behind.

## Convoy Drivers

As a general guide, convoy drivers should:

- Not carry or transport any form of weapons, narcotics, and/or spirits.
- Not depart without the authorisation of the convoy leader and/or authorised convoy organiser.
- Not hand over any fuel or communication equipment, money, or cargo contents to any persons on the road unless they are part of a planned delivery/distribution process.
- Not participate in any inappropriate behaviour (including but not limited to, any form of intoxication, harassment, sexual harassment, abuse of power). Appropriate behaviour of convoy personnel should be mandatory.
- Drivers must carry all the necessary legal documentation clearing them to drive in the areas of operation.

Title

Download - Convoy Planning Template

File



## Rail Transport

Compared to other forms of cargo transportation, rail transport is quite safe. Rail transportation is capable of high levels of passenger and cargo movement while maintaining energy efficiency, but is often less flexible. Rail transport costs less than air or road transport, making it extremely cost effective for inland movement.

## Common Terms in Rail Transport

---

**Railcar** Any type of pre-made container designed for transportation of goods using rail locomotion. Railcars are unpowered, and require an engine to push or pull them. There are a variety of rail cars designed to accommodate a variety of shipping needs.

---

**Engine** Powered vehicle that is operated by a pilot and is used to push or pull railcars over long distances. Engines can be electric, or powered by fossil fuels.

---

**Full Carload** A volume of cargo that is capable of filling an entire rail car.

---

**Less Than Carload** A volume of cargo that is less the volume required to fill an entire railcar.

---

**Railyard** A large open area alongside train tracks where trains can be domiciled or repaired. Railyards are also where cargo loading and offloading operations occur.

---

**Heavy Haul** Train cargo that is considered bulk or full cargo, as opposed to passenger rail vehicles or light rail (usually inner city public transport).

---

**Interchange** The act of switching cars between one train and another.

---

## Rail Transport Arrangements

**Containerisation** – much like sea freight, many railways can accommodate containerised

cargo. There are no differences between the [containers used in sea shipping](#) and those use in rail shipping. The process of stuffing and sealing containers may occur at the shippers facility, or may occur at a consolidation point or forwarders facility. The same volume and weight restrictions apply to rail shipping using containerisation as they do to sea shipping.

**Loose Shipping** – shippers may wish to ship less than full rail car loads using rail, or may not have access to intermodal container shipping through the desired rail line. Cargo can still be shipped using a variety of rail cars. Sending palletised or loose cargo via rail is similar to sending cargo with a third-party trucking company – cargo will be loaded onto the train utilising pre-made and usually hard sided structures, and will be offloaded on the receiving end. Usually, shippers aren't even allowed into the rail yard to participate in the loading/offloading of rail cars, and will only see cargo as it's picked up outside the railyard, or once it's delivered to their facility. Securing shipping for loose cargo via rail can be done through any freight forwarder or broker, and rail lines may even have direct customer service.

## Unique Concepts to Rail Transportation

**Infrastructure Limitations** - Rail transportation has a far limited scope compared to most other forms of cargo movement. The reality is rail movement needs specialised built out infrastructure – a rail network – that requires maintenance and is easily damaged by weather or conflict. Shippers utilising rail to move cargo have very few options – the size of railcars is limited by the overall size of the tracks, and freight trains have a fairly limited set of destinations. In many contexts where many aid agencies work and operate, there will likely not be a functioning rail network all together.

**Inflexibility** - Rail is very suitable for the movement of large load sizes over longer distances, but it lacks the versatility and flexibility of motor carriers since it operates on fixed track facilities. Rail can only provide services terminal to terminal, rather than point to point delivery services offered by trucking. Though rail transport offers an effective method of bulk haulage, it can be very slow, especially considering loading, offloading, and overall railyard operations.

## Sending Cargo by Rail

### Rail Transport Documentation

**Rail Waybill / Freight Waybill** - Documentation for movement by rail is controlled through the rail waybill. Unlike a BOL, CMR or AWB, the rail waybill is a nonstandard, non fixed-format document. Rail waybills are typically created by and supplied by the rail line, and will contain locally relevant and important information.

The rail waybill is a non-negotiable document containing the instructions to the railway company for handling, dispatching and delivering the consignment. No other document is required for domestic shipments, however shippers may wish to include additional information such as a detailed packing lists. For international transport across borders, shippers should be made locally as to the proper documentation needed.

Example Rail / Freight Waybill:

PLACE SPECIAL SERVICE PASTERS  
HERE

**FREIGHT WAYBILL**

TO BE USED FOR SINGLE CONSIGNMENTS, CARLOAD AND LESS CARLOAD

CAR INITIALS AND NUMBER		KIND	LENGTH/CAPACITY OF CAR	
			ORDERED	FURNISHED
STOP THIS CAR AT			CONSIGNEE AND ADDRESS AT STOP	
TO STATION			FROM	STATION
ROUTE			SHIPPER	
RECONSIGNEED TO STATION			AMOUNT	WEIGHED
CONSIGNEE AND ADDRESS			C. \$	AT
			O. \$	GROSS
<small>WHEN SHIPPER IN THE UNITED STATES EXECUTES THE NO-RECOURSE CLAUSE OF SECTION 7 OF THE BILL OF LADING, INSERT "YES".</small> <small>Indicate by symbol in Column provided * how weights were obtained for L. C. L. Shipments only. R—Railroad Scale. S—Shipper's Tested Weights. E—Estimated—Weigh and Correct. T—Tariff Classification or Minimum.</small>			D. \$	TARE
			PICKUP SERVICE	ALLOWANCE
ON C.L. TRAFFIC-INSTRUCTIONS			DELIVERY SERVICE	NET
			RECEIVED	IF CHARGES ARE TO BE PREPAID, WRITE OR STAMP HERE "TO BE PREPAID."
			ON L.C.L TRAFFIC TRANSFER STAMPS	
NO. PKGS.	DESCRIPTION OF ARTICLES	*	WEIGHT	

## Cargo Configuration for Rail Shipping

If not utilising intermodal shipping containers, shippers generally have very little control over how cargo is loaded, nor are there many special considerations while packaging cargo. Cargo may be shipped palletised or loose, however it may be in the best interests of the shipper to palletise and label cargo as much as possible to minimise loss or theft while in transit. Trains can haul heavy and large cargo, and are really only limited by excessively oversized items, such

as oversized construction equipment. Certain routes may be limited by tunnels or underpasses, so shippers should inquire with their forwarders about the overall limitation for shipping using a specific rail line.

The overall types of railcars used for shipping are:

**Box Car** – The most common form of pre-made purpose built rail car. Box cars are sealed on all sides and have hard, rigid structures with locking doors. Box cars need to be manually loaded, similar to the bed of a box truck.

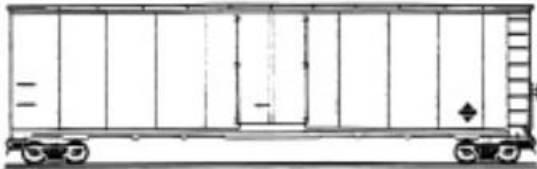

**Flat Car** – A car without hard siding, used to transport wide or tall cargo such as vehicles and construction equipment. Flat cars can also house standard shipping containers. Flat cars can also be used for regular cargo, but would expose regular cargo more to the elements and theft.

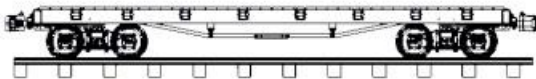

**Hopper Car** – An open top box car with reinforced support under the long edges. Hopper cars are used for hauling large quantities of loose bulk items, such as grain, sand, ore, or anything non liquid that can be dumped directly into the body of the car. Offloading may be done by hand or MHE. Some hopper cars are capable of tilting to rapidly offload bulk cargo at once.

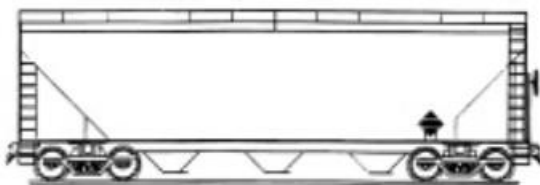

**Tank Car** – Can be low-pressure (liquid) or high-pressure (gas). Ideal for moving large volumes of liquid long distances. There may be restrictions on the liquid and gas types due to national and local laws and limitations on handling hazardous goods.

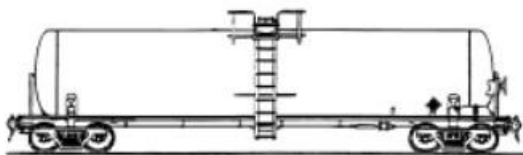

## Inland Waterways and Rivers

Where road and rail transport are not possible due to lack of infrastructure it may be necessary to transport goods by river, delta, marshes, canals or other form of inland waterways. The mode of transport will be informed by the nature of the inland waterway, including depth, water current, necessity for speed of delivery, and ability to load/offload at remote locations and destinations.

## Barges

Under very specific circumstances, barges can be an extremely cost-effective way of moving large volumes of cargo relatively large distances. Barges are wide, flat river vessels with low edges, have flat bottoms, and have a shallow draft. This makes barges ideal for use in calm flat and shallow waters like a river, but largely unsuitable for turbulent waters like the open ocean. Barges can come in two configurations:

**Self-propelled** – Self-propelled barges have a connected cabin and engine mount, and move as a single piece. Usually the engine is designed for moving large loads, but isn't meant for speed.



**Dumb Barge** – A “dumb” barge is a non self-powered floating platform, capable of holding cargo, but is without steering or an engine. Dumb barges require an external boat to move, including a tow boat or a “pusher,” a separate motivated boat that is specifically designed to push or pull dumb barges along waterways.

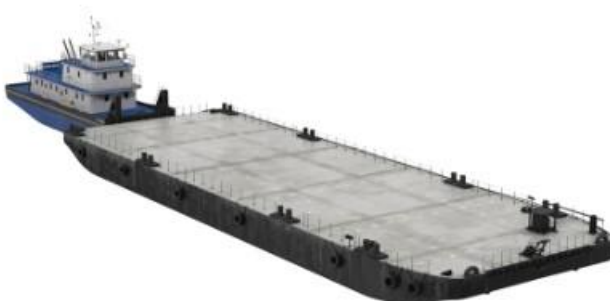

The barges themselves are divided into three general categories:

**Flat Deck** – A barge on which the deck stowage is one large flat surface, upon which cargo rests and is secured to. Flat deck surfaces on barges are very exposed - they won't protect cargo from waves or from turbulent water, and items stored on the surface of flat decks can be easy targets for thieves. All cargo transported on the surface must be properly secured and tied down, and valuable items stored in a manner that won't enable easy theft.



**Hopper / Split Hopper** – A barge with one large or many smaller compartments that are partially below the edge of the barge. Hoppers can be used to store bulk loose items such as grains, sand or ore. Many hoppers can be covered with tarp or hard metal lids to protect contents, and some can even store additional cargo on top of the hopper compartments. Depending on the cargo, hopper/split barges can be loaded by hand or specialised MHE.



**Tanker Barge** - A barge designed to carry liquids or compressed gasses. Tanker barges requires specialised maintenance, and will only be used if the sending and receiving ports have the proper equipment to load and offload.





Barge movement is likely the cheapest mode of moving cargo inland into a country, however it has limitations. Barging operations are extremely slow; the loading and offloading process can take days or weeks depending on the load type and the journey itself can take weeks to accomplish. Barges are also further limited by the ability to safely moor and offload at the point of delivery. Barges themselves can be impacted by seasonal changes to the riverway, making areas impassable for periods of time.

In reality, there are only a few locations globally where barges will be effectively used in a humanitarian response operations. There is no standard form of documentation for utilising barges, and users of barge services will need to supply their own tracking documentation and process their own customs formalities if required to.

## Boats

Inland water ways can be navigated by boats of the appropriate sizes. Smaller boats have the advantage of moving quickly and fitting into smaller water inlets, however will also be limited in the volume of cargo they can carry. Agencies may wish to rent or lease their own boats for rapid response operations.

There may also be large riverway shipping operations on vessels capable of carrying relatively large volumes of cargo. Utilising third-party riverway shipping should be treated the same as utilising any local third-party transport.

## Pack Animals

Any goods being moved via animal must be packaged in relation to the weight that the particular animal can safely and humanely carry. There are many possible variations of available local animals depending on geography, climate, the local economy, and a variety of other local conditions.

A general guide to working limitations of different pack animals might look like:

Animal	Load Capacity	Daily Work Rate	Region
Elephant	500 kg	5-8 hours/walk 24 km	Asia
Donkey	50 kg	Mountain, 8 hours	Middle East, Africa, South Asia, Latin America & Caribbean
Mule	50 kg	Mountain, 8 hours	Middle East, Africa, South Asia, Latin America & Caribbean
Llama	50-80 kg	8-10 hours/walk 30 km	South America

Animal	Load Capacity	Daily Work Rate	Region
Horse	60 kg	6 hours	Asia, Eastern Europe, Middle East & North Africa
Bull	150-250 kg	8-10 hours	Middle East & North Africa, South Asia
Camel	150-250 kg	Walk 50 km	Middle East & North Africa, South Asia
Yak	70 kgs		South Asia

*Pack animals estimated their work rates - WFP Transport and Logistics Manual*

Speaking with a local expert is strongly advised when developing an animal delivery plan. Typically, use of pack animals will be negotiated and contracted directly with the owners, or those in control of the animals who will be responsible for the transport. These may include:

- Village elders.
- Local authorities.
- Committees of animal owners.
- Local NGOs.

Transport documents will vary, but a variation of the standard method may be used, possibly amended as follows:

- Issue one waybill for each group.
- Divide the animals into groups under one supervisor.
- List animal owners and number of animals provided by each individual.
- Assign a quantity of consignment to each group, for accountability.

All contracts for carriage by pack animals should still undergo the standard procurement process established by each individual agency, and and be within each agencies procurement procedures.

## Cargo Capacity Calculator

**DISCLAIMER:** This calculator is for planning purposes only. Real world conditions can and will dictate the actual loading capacity of vehicles and number of trips required.

- The real uplift capacity of air-craft is contingent on weather, altitude, distance flown, and other factors. Real world conditions will limit total cargo transport capacity. [Read more information here.](#)
- Volume limitations per truck are purely estimates. Real world transport vehicles, load plans and prevailing laws will have a wide impact on actual volume capacities. [Read more information here.](#)

## Transport Tools and Resources

## Templates and Tools

[Guide - Aircraft Cargo Specifications](#)

[Guide - Container Specifications](#)

[INCOTERMS 2020](#)

[Guide - Vehicle Body Types](#)

[Guide - Correct Cargo Loading](#)

[TEMPLATE - Cargo Manifest \(Flights\)](#)

[TEMPLATE - Packing List](#)

[TEMPLATE - Proforma Invoice](#)

[TEMPLATE - Waybill](#)

## Warehousing and Physical Stock Management

### Common Terms in Warehousing

---

<b>Stock Keeping Unit (SKU)</b>	A unique code or nomenclature that designates a single line item of a larger consignment. SKUs may be tied to a specific production run or expiration date, and may denote only a product of specific characteristics. A single storage facility with multiple SKUs will require very different handling procedures than a storage facility with few SKUs.
---------------------------------	--

---

<b>Inventory Unit</b>	The lowest unit at which stored cargo items may be counted at. An inventory unit may be an individual item (example: blanket), storage container (example: bottle of pills) or kit.
-----------------------	---

---

<b>Handling Unit</b>	The lowest unit at which a stored cargo item is handled. In the context of a warehouse, the handling unit may be a carton that contains many inventory units. A handling unit may be a single unit, or an entire pallet.
----------------------	--

---

<b>Material Handling Equipment (MHE)</b>	MHE is any form of mechanical equipment used to facilitate the loading and offloading of cargo, or the movement of cargo around an open space such as a port or a warehouse. MHE includes forklifts, cranes, pallet jacks, and more.
--	--

---

<b>Pick Order</b>	The order generated by a requestor and communicated to a warehouse indicating the quantity and type of SKUs to be pulled from inventory and shipped.
-------------------	--

---

---

**First In /  
First Out  
(FIFO)**

An inventory and asset management system in which the oldest received inventory items on hand are the first removed from inventory.

---

**First  
Expired /  
First Out  
(FEFO)**

An inventory and asset management system that emphasizes and the movement of items based on their relative expiration dates.

---

**Non-Food  
Item (NFI)**

Any stored item that is not food in nature. In the humanitarian context, NFI items usually refer to durable, non-perishable items such as household and shelter materials. NFI management in humanitarian settings usually does not require advanced storage solutions, unlike storage of medicines or medical consumables which may require temperature controls.

---

## Warehousing Strategies

“ ‘A warehouse is a planned space for the storage and handling of goods and material.’  
([Fritz Institute](#))

The overall warehousing needs of a humanitarian organisation are generally specific to the needs of individual response activities and the overall objectives of the organisation itself. Organisations that deal with large volumes of non-perishable goods may need to have multiple warehouses in multiple locations, while organisations that focus on targeted special interventions – such as psychosocial programming – may have very limited need for a detailed warehousing strategy and may choose to procure and deliver directly from vendors as required by the project. Beyond just anticipated volumes of goods, special storage needs will also dictate a warehousing strategy; managing medical commodities requires far more detailed stock management and possibly specialised storage conditions, while durable non-food items (NFIs) may hardly need anything more than basic protection from the elements.

In general, humanitarian aid agency's follow a model for delivering goods to affected beneficiary populations similar to commercial distribution networks, comprised of international and local warehouse facilities that serve as consolidation points, feeder facilities and last mile distribution points.

Example: Overview of a general humanitarian supply chain and warehousing needs.

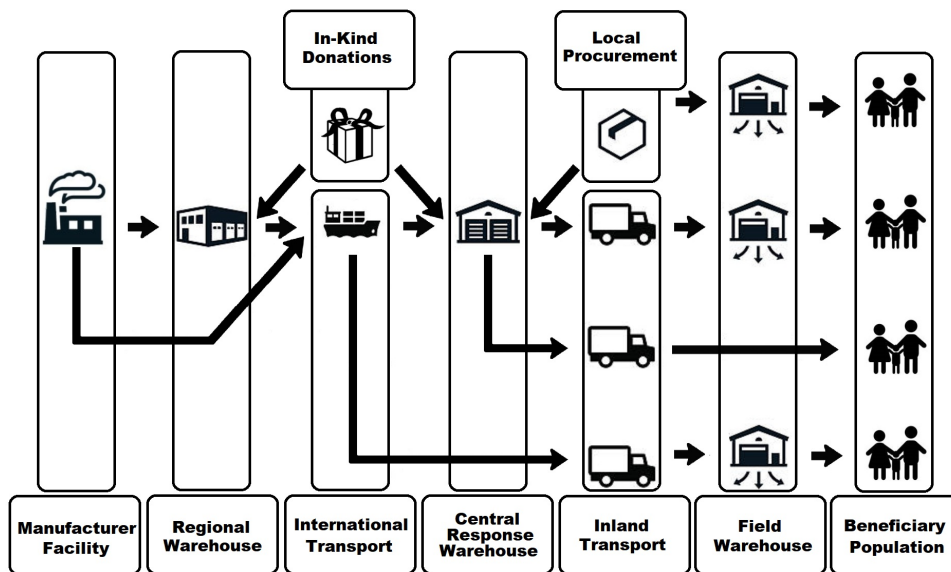

## Regional/International Warehouses

Many international humanitarian response organisations have adopted a strategy of pre-positioning relief supplies in large warehouses not located in the countries of response operation, usually located in one or more strategic regional locations. The development of regional warehouses as lead to a general reduction in time required to respond to rapid-onset emergencies, as well as promotes a more reliable and consistent supply of physical relief items for countries of operation located around the region served by the warehouse.

An international or regional warehouse serves as consolidation point for items as they are received from vendors, donors or partners, enabling humanitarian response organisations to inspect, kit, segregate, repackage, or otherwise prepare cargo for further onward movement. In doing so, regional and international warehouses function as both pre-positioning facilities – holding cargo in case of a rapid unforeseen emergency – and as a feeder facilities – warehouses that slowly resupply warehouses further down the supply chain.

Though many agencies have adopted the regional facility strategy, regional warehouses should not be considered an automatic or default solution. Maintaining a large warehouse - especially one in a remote location not necessarily in the same country as an agencies headquarters – can be quite expensive, and requires additional staffing and time to ensure basic standards are met and the facility properly functions. If an agency is not prepared to commit to paying for multiple years of storage in a remote location, or cannot support the technical oversight or man-hours associated with the proper running of a facility, the agency may choose to completely outsource its regional warehouse management, or forego a regional response warehouse altogether.

### Positioning a Regional Warehouse

When deciding on the location of a regional warehouse, the following points should be considered:

- Readily available access to a high volume of intermodal international transport – Is the warehouse near seaports and airports of sufficient size and throughput capacity?
- Relative location to the area of response – Does the region have sufficient response activities and does the location match the overall area of planned intervention?

- The nature of planned interventions – Will the warehouse serve rapid response activities? Or will the warehouse only feed into longer ongoing activities?
- Political climate of the country – Is the government of the country in which the regional warehouse located stable and not prone to conflict, ouster or drastically changing policies?
- Economic feasibility – Is operating in the country cost effective? Are there incentives such as free trade zones or humanitarian exemptions that reduce costs of international operations?
- Access the correct amenities – Does the location have facilities of the right size and quality required? Is there need for climate controlled or bonded storage?
- Access to sufficient technical support – Are there skilled labourers/companies readily available on the market who can manage and conduct special tasks like repairs?

Any of the above mentioned points can have adverse effects on the ability of a regional warehouse to perform its core functions.

## **Operations of a Regional / International Warehouse**

Regional/international warehouses can be purpose built or purpose designed facilities operated by permanent staff that has been trained in all the areas necessary to run an efficient facility, or stock can be held utilising some version of a third-party logistics provider (3PL) staff and facilities. Ideally, any regional or international warehouse would use computer-based inventory management tools, with software to help in the planning and management of the warehouse. The operating environment of a primary regional or international warehouse used for pre-positioning should typically be relatively stable, and overall attention focused on the efficient and cost-effective warehouse operation. Numerous organisations have centralised pre-positioning facilities strategically located globally. Some of these offer extended services to other humanitarian organisations on a cost-plus operating charges basis, such as the [United Nations Humanitarian Response Depot \(UNHRD\)](#) Network.

## **Central Warehouse – Area of Response**

The need and number of warehouses required in an area of response depends on volume and type of activities undertaken and locations of operation. Many response organisations prefer to keep at least one central warehouse in a country or area of response.

A central warehouse in the area of response is typically in either the capital city of the country of response, or in a major commercial hub within the country of response with sufficient infrastructure. The ultimate location of the central warehouse can be anywhere, insofar as it meets the needs of the organisation and the response objectives. In large areas of response, or in large activities, organisations may want a large warehouse in more than one location. The general position of a large central warehouse usually includes its relative proximity to sea and airports, manufacturing facilities, highly skilled or specialised labour or services, and readily available in-country transport services. Central warehouses can be directly managed by the agency, including staffing, rent and security, however in contexts with sufficient commercial activities, a central warehouse may be contracted out to a third-party provider.

The central warehouse serves as the primary reception point for goods flowing into a country, as well as a consolidation point for goods purchased locally. The size of a central warehouse depends on the anticipated volumes of goods themselves, the expected throughput of cargo, and the ancillary activities such as kitting that may occur on site. The overall purpose of a centralised warehouse strategy would be to provide sufficient and controlled flow of relief items to more remote or harder to access locations, keeping enough on hand to meet demand

at all times. Some organisations may wish to forego a central warehouse strategy all together in lieu of arranging direct deliveries from vendors or international ports of entry to field warehouses or beneficiary distribution sites.

## Field Warehouses

Field level warehouses are another strategy many response organisations have adopted. A field level warehouse is usually towards the end of the supply chain, near the last point of distribution to the beneficiary. Field warehouses can come in a variety of formats, ranging from tents and mobile soft sided structures to small hard sided structures. Some field warehouses might be just as large as a central facility depending on need; what defines a field facility is its proximity to programmatic activities and its role as the last stop en route to beneficiaries.

Field level warehouses usually do not have same level of built up infrastructure as central or international warehouses. Storage conditions at the field level are usually limited at best, and significant improvement might be required for special storage such as temperature-controlled requirements. Security in field level warehouses is also a primary concern, and additional infrastructure such as built up fences and additional guard services may be required. Cargo will likely be moved and stacked by hand with limited storage equipment such as shelving available.

The warehouse work force may be casual labour that has never worked in a warehouse before, while the inventory system is more likely to be paper based. Often, the situation while setting up a field level warehouse initially chaotic, sometimes dangerous and coupled with a humanitarian need which may be very urgent. The management style must therefore be practical and action oriented with a focus on making the humanitarian goods available as quickly and efficiently as possible, while remaining accountable at the same time.

## Storage Arrangements

When approaching warehousing, either at an international or response level, there are a variety of options available. Some options – such as government partnerships or temporary structures – make sense for short term or emergency contexts, while larger more sophisticated warehouse solutions might require long term investment and substantial resources over time. Below some of the solutions available to humanitarian agencies.

**Self-Owned / Self-Managed Storage** – Many humanitarian agencies with long term strategies and well-defined response plans choose to run their own warehouse facilities on a permanent basis. Self-managed solutions include owning an entire warehouse structure and the ground surrounding it, owning a warehouse structure but leasing the grounds upon which it's built, or renting or leasing an entire warehouse/storage facility and the grounds surrounding it.

Self-managed warehouses can bring total control to an aid agency, but come with their own challenges:

- Needing to identify and manage physical space.
- Identifying, training and managing personnel.
- Assuming most or all cost and risk associated with running the facility.
- Establishing and adhering to warehousing and stock management policies.

Due to the nature of most humanitarian contexts, agencies tend to own or operate their own facilities in the affected countries. As such, humanitarian agencies focus on and develop strategies largely for country and field level warehouses, sometimes with an emphasis on the

lowest operating parameters. Agencies may choose to self-own or self-manage larger regional or international warehouses too, however this comes with increased complexity and operational knowledge.

**Commercial** – Commercial rented or leased warehousing space can be a very attractive option for many agencies, either for rapid short-term solutions or for remotely managed facilities.

Renting commercial space brings several advantages:

- Permanent storage structures already built.
- MHE and racking/storage equipment already installed.
- Advanced warehouse management software may already be in place.
- Warehouse workers already trained and readily available.
- Security precautions already taken.
- Flexibility.

Storage with a commercial third-party provider can vary based on contract type; humanitarian agencies may wish to rent an entire warehouse facility for themselves, or they may wish to only pay for the physical space inside a warehouse that they use. The nature of billing for commercial warehouses varies between contracts as well, but the following rates are common:

- In and out charges per pallet or cubic meter.
- Storage rate per day/week/month, charged per pallet position occupied or cubic meter.
- Packaging and labelling fees.
- Offloading/Loading charges per vehicle.
- Monthly/annual security and insurance charges.

Buying into a warehouse arrangement – especially one managed by a large international company is a good way of increasing covered storage space quickly, and is useful for storage sites in regional or international settings where permanent employees of the respective aid agencies are not based. Commercial warehouse solutions tend to only be useful in more developed contexts, or areas not prone to civil unrest. Commercial warehouse providers are also not humanitarians by nature, and may engage in activities that humanitarian organisations disagree with, such as support to military activities. Each of these factors will need to be considered by agencies entering a commercial option.

**Government or State Facilities** – Government or state-run facilities include any storage situation in which a state or acting agent on behalf of a state manages part or all of a storage facility. Storage in customs facilities at ports, harbours, airports, and cross border transit depots will be government managed or run, and humanitarian cargo passing through such storage facilities is quite common. Some humanitarian organisations may choose to partner with local and national governments in non-customs or security settings, utilising government storage and/or augmenting government capacity through equipment and training. When partnering with governments, agencies must balance the anticipated capacities of the government in question as well as the need for impartiality and neutrality. Such decisions are entirely up to the mandates and tolerance thresholds of the individual agencies who may choose to do so.

**Partner/Common Storage Facilities** – Some humanitarian agencies may wish to participate in communal or partner managed common storage options, such as those offered by Logistics Cluster partners in field settings or the United Nations Humanitarian Response Depot Network in key and strategic regional locations. Humanitarian agencies may also wish to enter into storage agreements between each other, however this typically requires individual agencies reaching contractual terms on risks and liabilities of each. Partner storage agreements might be extremely useful in the early days of an emergency, when warehouse space is limited or



agencies may only have a limited presence of days or weeks at a time.

## Types of Warehouse Space

Within the different storage arrangements available to partners, there are different functions that each of these facilities may provide. Some of these functions might include:

- **Transit** - for temporary storage of goods destined for different locations and need storage for a very short time.
- **Pre-positioning** - stock meant for unknown emergencies, usually sitting for long periods of times before being called forward. Stock in these facilities is usually designed with long term storage in mind.
- **Bonded Storage** - for storage of goods whose duty is unpaid and especially where the goods are destined to another country. Pre-positioned stock is often held in bonded storage to facilitate export. Customs holding facilities are usually bonded, but private companies can be certified bonded as well.
- **Open Storage** - storage contained in the open air, usually in a secure area. Not ideal for perishable products. In emergencies, sometimes open storage is the only alternative.
- **Temporary Structures** - usually capable of being established quickly in areas where regular permanent storage solutions aren't available. Temporary structures might include tents or Mobile Storage Units (MSUs).

## Warehouse Management

Once a warehouse or storage location has been selected meeting the needs of the humanitarian organisation, and the overall response plan, and the facility has been fully restored or renovated to match the storage requirements, agencies will have the opportunity to design the physical layout of the warehouse space and any associated MHE or storage aids. It is important to understand the basics of a warehouse layout upfront to avoid problems later.

## Physical Warehouse Layout

A proper warehouse layout should not impede the physical flow of work, increase the risk of damage to items, or impact physical safety of any persons in or around the warehouse.

Warehouses ideally follow the 70/30 rule - around 70% of the floor space of a warehouse will typically be used for storage of physical cargo, while around 30% will be open space for movement and work. The percentages are of used floor space are only guidelines, and space utilisation can be slightly more as needed. A warehouse should never be so full that cargo cannot be accessed, or persons cannot walk around safely inside. All cargo storage should be clearly visible and easy to navigate, and any person in a warehouse should be able to quickly identify locations of items and conduct piece counts with minimum effort.

Warehouses are usually arranged in easy to navigate grid like patterns, with "lanes," "aisles," and "rows" - open spaces between racks, rows and stacks of items that enable the free flow of people cargo and MHE. The width of aisles and rows depends on context; lanes in small storage facilities utilising ground stacking and no MHE should be .5 - 1 meter wide to enable access to human movement, while lanes in a large warehouse with racking may be up to 4-5 meters wide to enable access to forklifts or hand trucks. Lanes and aisles should be free from debris or cargo that could block the movement of people or handling equipment. There should be what is known as a "fire lane" - a free and open space between cargo and walls of a suggested 40 cm or the safest available space through which an adult human can move to enable quick exit.

Exits in a warehouse should never be blocked, and in large commercial facilities exits should be clearly marked.

Cargo must never be pushed up against walls or touching ceilings. In addition to making accessing cargo difficult, stored items touching the sides of structures runs a greater risk of mould or water damage, and cargo touching the ceiling can be an indication of cargo stored at unsafe heights. It is also advisable to keep a space at the loading/offloading areas of the warehouse to facilitate handling of cargo as it comes into/exits the facility. The size of the open space near loading areas depends on the size of the warehouse and anticipated activities – small facilities may only need a few square meters to manage sorting, while large facilities may need whole kitting arrangements.

**For smaller remote warehouses or mobile storage units (MSUs)** -Small field warehouses are likely going to be stocked and managed completely by hand. Proper layout can help ease the hand management process. Heavy or bulky items may be stored closer to exits of storage units to minimise efforts to manually move, while frequently used items should be moved closer to the front of the storage site to minimise distance required for porters to manually load/offload.

Example small field storage facility with ground stacking:

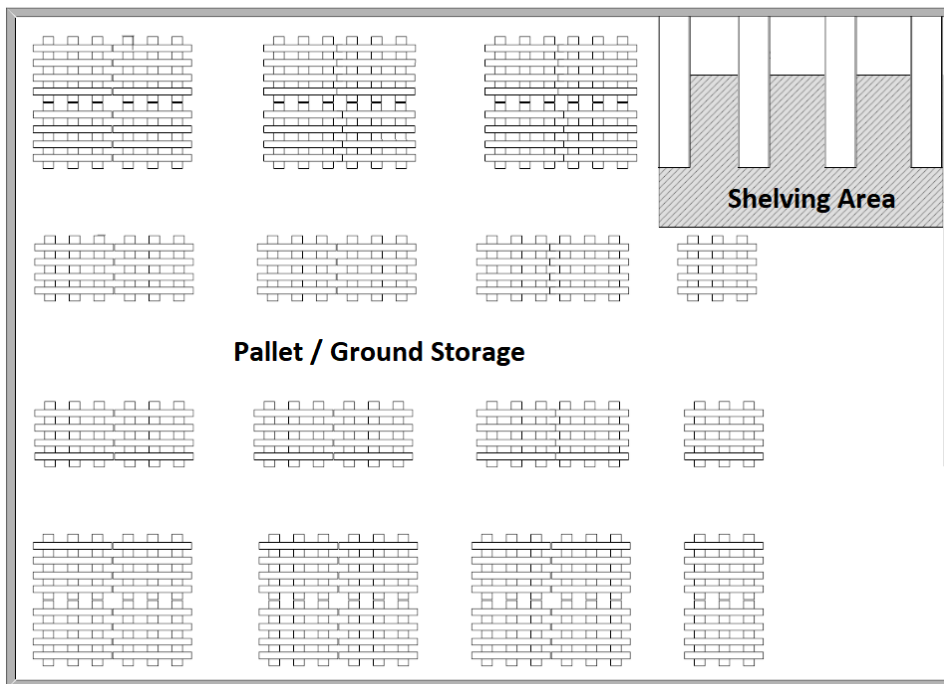

**Larger Built-up Warehouses** – Larger, more built up warehouses and storage facilities have a variety of layout and space management options. The overall need for the various components of a warehouse are dependent on the needs of the agency and the physical features of the available space. Some of the things aid agencies may wish to consider when looking at larger warehouses might include:

- Kitting areas identified and clearly demarcated. Kitting can occur inside the facility or outside the facility, depending on weather and available space.
- (Potentially) offloading and loading will occur in a different loading bays to facilitate the flow of cargo.
- Clearly defined staging areas for consolidation, loading and offloading.
- Climate controlled and other lockable facilities built or converted inside the warehouse, out of the way of the main warehouse flow.

- If any racking, shelving and bulk storage configurations are used at the same time, they are separated in clearly demarcated areas.
- If handling equipment such as forklifts are used, there are clearly defined areas where the forklift drives, ideally marked on the ground in visible paint or tape.
- Pre-defined parking and storage spaces for MHE. If MHE is using electricity, parking spots can also be charging locations.
- Use of drive up loading bays. Bays should be kept free from debris. Recessed bays prevented from flooding with proper drainage, and ramps must be adequate to fit and hold trucks.
- Roll up or swinging doors big enough to accommodate any handling equipment or cargo size.

Example warehouse floor plan of a larger warehouse operation:

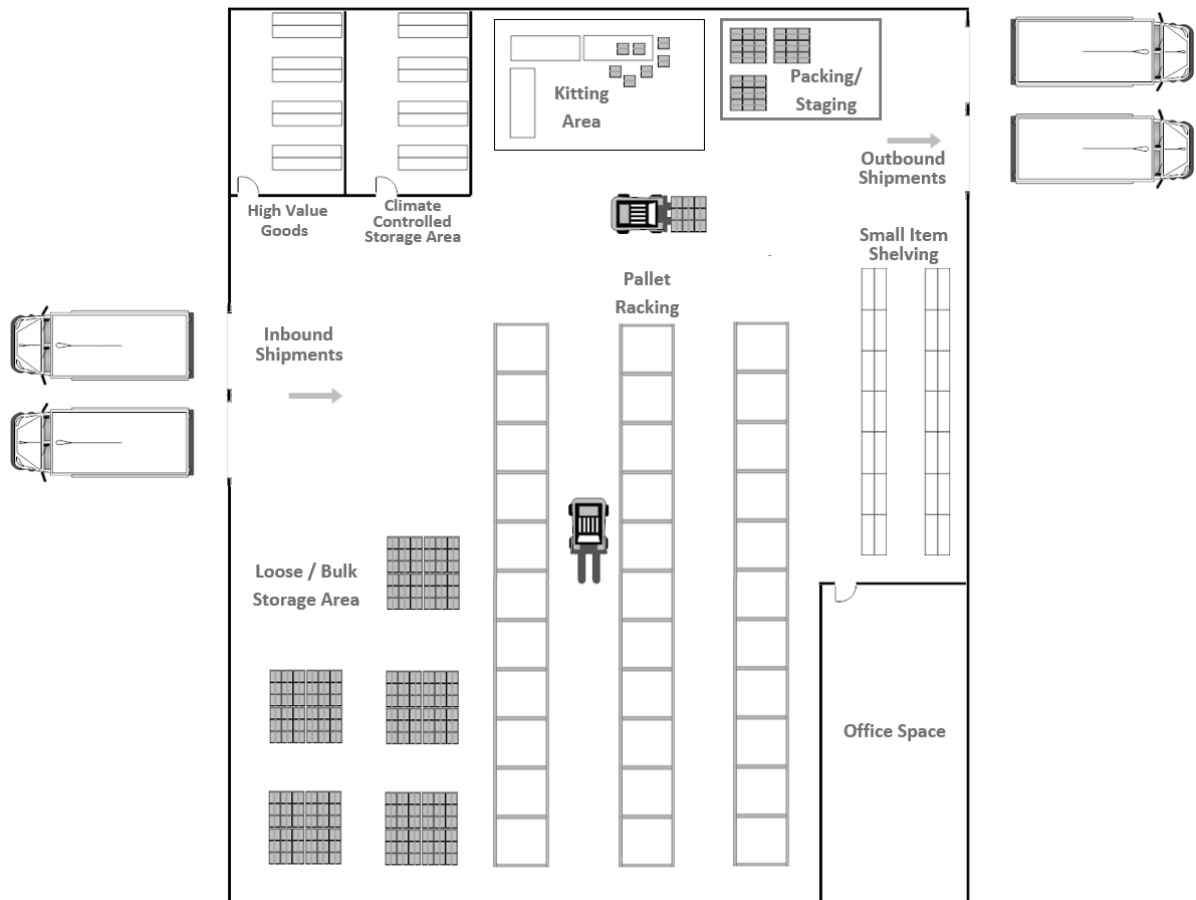

## Zonal Storage

Irrespective of the structure type or the size, space planners should consider planning the physical location of stored items relative to the amount of effort required to move or load them, including:

- Their size / weight
- Their frequency of usage

SKUs that have the highest volume of turn over - meaning the highest numbers of in and outs - should be stored closer to the cargo loading points of the warehouse or storage facility. The time and effort saved when moving these items between storage location and points of loading/unloading will have long term impacts on the overall timeliness of operations.

Inversely, less frequently used items should be stored further away from the storage facility points of loading.

An exception to storing infrequently used cargo in the rear of a facility is planning on storing extremely heavy or difficult to move items near the front of a warehouse or storage facility, even if they are used only rarely. Items like machine parts or generators might be cumbersome or even dangerous to move around inside of a storage site, and keeping them closest to the exit is an advisable strategy. This is especially true for storage locations that are entirely managed by hand - planners should think of the physical capabilities and safety of loaders.

#### Storage Space Zonal Plan:



## Site Selection Planning

There are many things to consider while selecting a location and/or a structure in which to establish a warehouse/storage facility. Rapid assessment templates for identifying storage space can also be found in the [Assessments and Planning section](#) of this guide.

## Anticipated Cargo Needs

When planning a new warehouse space, organisations should consider what the anticipated cargo needs will be. Cargo needs will at least include the maximum anticipated volume at any given time, however they should also factor for special handling requirements or special activities, such as kitting. Understanding the full scope of the warehouse may require consultations between program and logistics personnel, and a mapping of programmatic activities over the coming period of time. Even a relatively small volume of cargo may require a large area in which to operate.

When anticipating the cargo and relief item storage needs, some of the following items should be considered:

- Total anticipated volume of cargo for the specific storage location.
- Numbers and types of independent types of goods (SKUs) needing to be accounted for.
- Interior space adequate for the anticipated flow of work.
- Need for handling equipment (MHE) for cargo items – MHE parking spaces, recharging, etc.
- Duration stored goods will stay for / the duration the storage site may be required for.
- Need for ancillary activities – repacking, labelling, kitting, break bulk, etc.
- Speed at which throughput/ancillary activities may be required – multiple loading bays,

- large dispatch area, etc.
- Need for special storage - cold chain, dangerous goods, etc.
- Additional planned buffer stock required.

More information on identifying and estimating cargo can be found in the section [Finding Cargo Dimensions](#).

## Irregular and Special Storage

As agencies attempt to plan out space need in storage locations, they may encounter bulky or irregular items. In addition to planning generic outside dimensions, space planners should also estimate the fully required volume to adequately store an item, not just the outside dimensions.

**Irregular Shapes** - Some irregular items, such as mechanical or farm equipment may have complex physical attributes that make space planning hard. When looking at highly irregular shapes, planners should consider the outside measurement of only the longest, widest and tallest parts of the item, as those are the parts that will come in contact with other stored items in a warehouse. To do this, planners should imagine an invisible box that is barely large enough to fit the irregular item, and use the "edges" of the "box" to calculate the total required space. In this way, the overall space requirement may actually be larger than they first appear.



**Nested Cargo** - Some cargo items can be neatly "nested," meaning that they can rest inside of or occupy space inside of each other. Buckets - a common humanitarian item - can fit inside one another, taking up considerably less space when stored appropriately. When planning space, organisations should account for nested storage by measuring the outer dimensions of the items while stacked/nested, and not the outer dimensions of the individual unit. In this way, overall space requirement may actually be less than they first appear.



## Physical Storage Space Aspects

Once the anticipated project and volume needs are established, organisations planning storage should review and assess the physical aspects and amenities associated with a potential storage space. Though there may be enough interior space to accommodate purely volumetric calculation, warehouses and storage sites may be lacking key infrastructure, or require substantial improvement to meet operational needs. A non-comprehensive list of physical space needs might include:

### Physical Terrain:

- Ample space for trucks to enter, park, load/offload and turn around.
- Warehouse/storage site is not prone to flooding or other extreme weather events.
- Impact on the soil/sand/ground in the truck parking/offloading areas and kitting areas during routine activities - will the ground remain unaffected, or will improvement and maintenance be required.

### Utilities/Amenities:

- Location/Building has access to basic utilities - electricity, water, communications.
- Location has bathroom facilities on site.
- If required, the storage space has separated compartments for different storage areas/different storage needs - climate controlled, secured areas, etc.
- A usable office space of appropriate size.
- The capacity to refuel trucks - does the site have existing refuelling tanks, or do tanks need to be installed.

- An employee break/rest area.
- Prayer rooms (if required).

#### **Structures:**

- Proposed warehouse site has an existing physical structure.
- Existing structure and surrounding grounds are in good condition – if not, consider required upgrades.
- If required, location has drive-up loading bays for vehicles.
- Location has adequate walls, doors, and ceilings – if not consider cost and complexity of required repairs.
- If required, location has existing racking/shelving.
- Storage space floors smooth and free from cracks, and capable of supporting required activities.
- Walls are flat and free from pipes, exposed electrical wiring, support beams or other protrusions that might impact storage.
- Structure is free from any perforations that may lead to water or pests coming into the facility.
- There is proper drainage around structure – if not, consider cost and complexity of making drainage.

## **General Storage Location**

The geographic location of the proposed site is also important – a poorly situated site may impact costs and time to adequately delivery humanitarian aid, and generally reduce opportunity to access markets and services. General things to consider when selecting a storage site are its proximity to key things, such as:

- Proposed site location is near the primary areas of intended use.
  - If in a capital city, consider the need for the warehouse to be near the airport/seaport.
  - If in a field setting, consider the need for the warehouse to near the intended distribution sites.
- Proposed storage site is near major arterial roads used for transport.
- Proposed location as easy access to transporters and casual labour.
- Storage facility will be easily accessed by organisation personnel.

## **Safety and Security**

Overall safety concerns should be included in planned warehouse and storage space. Safety measures might include the physical components of a warehouse, but also the prevailing security surrounding the proposed location. When considering safety needs of a proposed site, organisations should also include security personnel in the planning process.

- Physical structure has a fire suppression system, and emergency exits – if not consider costs of installing fire suppression equipment.
- Storage location has built up walls/fences and access gates.
- Storage location has guard post and guard quarters, and possibly available guard service – many storage sites will require agencies to contract their own guards.
- Warehouse is not near any known or anticipated major targets - military bases, police stations, government offices, etc.
- Warehouse is not near potential hazards – chemical processing depots, fuel stations,

landing strips, etc.

- Area is not known for security incidents in the past.
- Proposed location is not exposed and relatively inconspicuous, if possible.

## **Facilities Management**

Once a facility has been fully selected and its operations begin, agencies will need to continue to maintain, or ensure that the third-party associated with running the facility maintains the physical structure, supporting equipment, and immediate grounds around the facility.

## **Site Grounds**

The grounds around any storage facility should be kept open and free from objects as much as possible; debris, rubble, trash and weeds should be cleared out to avoid damage to vehicles and structures. Exposed wires or pipes should be properly buried or sealed; pipes or electrical equipment that cannot be buried should be well marked, painted red and/or have a secure or caged structure built around them. Drainage ditches should be clean and in working order at all times. Clogged or blocked drainage must be fixed to prevent flooding, and inadequate drainage must be dug if not already available.

Trucks must be able to enter, park, load/offload and depart the facility without difficulty, and ideally, more than one truck should be able to perform work at the same time. There should be adequate room for trucks to turn around in the allocated parking area; even if space is available, equipment or piles of scraps may hinder movement, possibly leading to delays or accidents. The grounds around truck parking and turning areas may need to be graded, paved or gravel/loam laid down to even the surface. An unimproved truck parking and turning space may lead to large grooves or divots in the ground, causing water to pool, mud to form, and vehicles becoming stuck or even damaging their undercarriages. Depending on weather patterns, truck turning and loading/offloading spaces may require continual maintenance seasonally or throughout the year.

## **Physical Structures**

For storage locations of all sizes, there are a number of considerations to be had.

Electricity will be required to operate office equipment, lights and communications equipment. If electricity is not available on site, generators must be installed if possible. Any installed generator will need to be specified to appropriately meet the anticipated power load of the warehouse; and under powered generator will cause equipment failures and require constant maintenance, while an overpowered generator will end up costing more in fuel and maintenance. If a generator is used, agencies must develop a plan for supporting a generator, including having a supply of fuel and spare parts, and identifying how the generator will be maintained and serviced.

If no bathroom facility is available on site, either one will have to be constructed or access to a restroom nearby defined. If the site has no running water, either a water distribution system will need to be installed and water tankered in, or some other form of water will need to be provided for washing. Drinking water should be made available to warehouse workers, and if no tap or purified water is immediately available, bottled water may need to be provided.

There should be space for office work to occur. Any office space should ideally be separated from the main warehouse floor, and have locking doors and drawers. Office spaces should be

provided with basic tools, such as a printer, stationary, desks and chairs, electrical sockets, filing cabinets and internet access wherever possible. Smaller facilities may lack the ability to keep office equipment on site, and as such basic supplies can kept in a locker, or carried with warehouse crews as needed.

Warehouses may require additional ventilation, based on the weather conditions outside and the types of commodities store inside. Many larger warehouses have soffit vents to enable hot air to escape as it rises towards the ceiling. Smaller storage spaces may not have the proper structures to support permanent ventilation, and may need doors open during working hours.

### **For Mobile Storage Units (MSUs):**

MSUs must be properly installed and maintained. Installation of MSUs must be facilitated by someone with experience in the process. Beyond just knowing how to assemble an MSU, MSUs must:

- Be built with either the front or back facing prevailing winds to minimise wind pressure.
- Should not be constructed in a low point, or in a location prone to flooding.
- (Ideally) MSUs Should be built on free standing slabs to elevate the MSU above waters caused by rains or flooding.
- MSUs must be properly secured, lockable from the outside and difficult for anyone to climb under the outer apron.

Damage to physical MSUs such as warping of beams or tearing of vinyl siding must be assessed, and repairs conducted by a knowledgeable person. Cracks or damage to MSU foundations must be repaired quickly to prevent further compromising the structure.

For Built-up Hard Sided Structures:

Damage to physical structure should be addressed and repaired. Cracks or holes in ceilings and walls should be addressed as soon as they are identified. Storage facilities should have solid, locking doors and windows. Windows that are low enough to be easily reached and accessed by an adult human should be covered with bars or grating of some kind.

Storage structures should have adequate inside lighting:

- If ambient lighting isn't sufficient for daytime usage, agencies should consider installing additional lights for daytime use.
- Light should be sufficient for operating at night time. Larger facilities may need extensive lighting installations.

## **Vector Management**

Vectors are defined as rodents, insects, or anything that may spoil or damage stock on hand. Proactive vector control is important; rats and insects don't just impact food – they can also damage anything woven from organic material such as blankets or clothing, and can completely destroy stocks of medical grade consumables. An untreated infestation of can lead to large problems down the road, any identified infestation or pest must be dealt with immediately. Warehouses will need enact some form vector control depending on the nature of the stock, including:

- Fumigation – external companies may be able to be contracted to provide fumigation services.
- Rat traps/glue – placing pre-made traps around the warehouse to capture rodents.
- Keeping warehouse floor clean at all times.



- Removing spoiled/rotten items from the general stock and disposing as soon as possible.

In the event an infestation is identified, records should be taken of the date and type of treatment used. Records can help schedule routine fumigation or product inspection, but also may indicate seasonal problems as well.

## **Fumigation**

The overall need for pest and infestation control depends on the duration, storage conditions and type of commodities stored. Food in particular is sensitive to attracting pests, and agencies specializing in food may have special fumigation schedules. A general best practice is to enact fumigation once every six months, however ideally stock should rotate quickly enough to avoid the need for fumigation. In other instances, fumigation may be required every 3-4 months, or as soon as an infestation is discovered. As a general rule most insect pests under humid tropical conditions can be expected to multiply about 50 every six weeks, meaning an untreated infestation can become a large problem very quickly.

Fumigation can be for an entire warehouse or storage site, or for just one portion of stock, however it is strongly advised to fumigate all perishable SKUs at the same time. Fumigation in storage contexts is usually done using what are called "fumigation sheets" or "gas tight sheets" - large impermeable tarps that cover stored items. When using these fumigation sheets, chemicals specifically used for fumigation are pumped under the edge of the tarp, while the edges of the tarps are weighed down to prevent air movement. Use of these tarps concentrates fumigation efforts into specific areas and maximizes impact.



When undergoing fumigation, workers and managers should always consider the following:

- Fumigation should only be carried out by a trained professional, or a specially licensed company. Agencies requiring fumigation services should enquire with their procurement team about what may be available on the market. At no point should an agency attempt to fumigate themselves without special training!
- Even if fumigation is done under tarps, workers should vacate the storage space until they can safely return, as indicated by a trained professional.
- Proper safety equipment should be used by all persons working with or around fumigation.

- Fumigated items will need to be properly aired out before handling or distribution.

After fumigation, continual inspection may be required. If infestations persist, there may be a need to alter storage or delivery methods. The use of additional liquid based pesticides may be required to spray around the exterior or floor of storage spaces.

## Physical Warehouse Maintenance Schedule

Below is a suggested periodic maintenance schedule for warehouse management.

	Clean	Check
<b>Daily</b>	<ul style="list-style-type: none"> <li>• Floors</li> </ul>	<ul style="list-style-type: none"> <li>• Signs of infestation</li> <li>• Locks</li> </ul>
<b>Weekly</b>	<ul style="list-style-type: none"> <li>• Walls</li> <li>• Sides of racks, shelves, fridges</li> </ul>	<ul style="list-style-type: none"> <li>• In-depth check for pest</li> <li>• Stability of racks, shelves</li> <li>• Exterior lighting systems</li> <li>• Perimeter walls/fences</li> </ul>
<b>Monthly</b>	<ul style="list-style-type: none"> <li>• Stored Items</li> <li>• Roof</li> <li>• Gutter</li> <li>• Truck parking areas</li> <li>• Facility grounds</li> </ul>	<ul style="list-style-type: none"> <li>• Wall cracks</li> <li>• Water leakages</li> <li>• Fire Extinguishers/Sand Buckets</li> <li>• Condition of handling equipment</li> </ul>

## Warehouse Equipment Maintenance Schedule

All equipment in warehouse facilities - including racking and shelving - will require periodic maintenance. This may include replacing parts, applying lubricants, checking batteries, conducting daily charging or cleaning, or just conducting ongoing inspection to ensure that service equipment and physical holding structures are not displaying signs of damage and distress. Generally, the service schedule for different equipment items will be provided by the manufacturer, however the overall need to conduct daily or weekly inspections may also depend on the size of the warehouse and the overall daily handling requirements. The larger the facility, the more pieces of equipment will likely require maintenance. Additionally, warehouses with high degrees of throughput may also require more regular maintenance. Warehouse managers should develop a [maintenance schedule for warehouse equipment](#) breaking down daily, weekly and monthly/yearly service needs, and should also maintain separate [logbooks for key pieces of equipment](#), such as forklifts. Proper tracking of maintenance will increase the lifespan of expensive items, and will increase overall safety of the warehouse environment.

## Handling Equipment and Storage Structures

The ways in which cargo is physically stored in a warehouse can dramatically increase usable storage space, increase efficiency, and impact safety. Generally, there are a few main categories through which cargo is physically stored and handled.

### Shelving

Unlike racks which are used to manage pallet sized loads, shelving used in warehousing is useful for:

- Small, low quantity, loose items – example: vehicle replacement parts.
- Items that are dispensed at small quantities – example: medications.
- High value items – example: computer equipment.

Shelving can easily be constructed in remote field warehouses from local materials, insofar as the local materials can physically support the required stored items. Shelving can also be installed anywhere inside a larger warehouse, however the location should make contextual sense. As an example, shelving may be used as an intermediary stage of order fulfillment; a warehouse may have pallets/large cartons of items small items, but only receive pick orders for low quantities. A reasonable quantity of stock may be moved to pre-defined shelf space to facilitate ease of fulfilling low or item level pick orders. Shelving may require a separated space physically separated from the main warehouse floor; high value items or controlled goods might be better suited stored on shelving in a separate lockable space.

Shelving installations should be ergonomic; shelves should not be so deep that an average height adult cannot reach to the back of the shelf, while shelves should not reach unsafe heights, and if possible, should avoid requiring ladders or stools to reach the top.



### Loose Stacking / Ground Storage

Ground storage includes anything that is stored on the floor of a warehouse, often compiled in stacks. Items stored on the ground should never be directly in contact with the warehouse floor; cargo should rest on pallets, or if pallets unavailable, tarpaulin. The general configuration of ground floor stacks will vary based on the storage needs, including:

- The number of different items SKU items that might require accounting.
- The weight of cargo limiting height.
- The physical nature of the cargo; cartons can be evenly stacked, while irregular kits in sacks might be piled like a pyramid.

Ground storage of loose items is quite common in humanitarian settings. Most remote field warehouses are usually too small to accommodate special equipment installation, lack the sufficient infrastructure to properly support MHE, or are temporary structures in nature. A substantial portion of humanitarian relief supplies don't necessarily require advanced handling either. There are several tricks to properly managing stacks of cargo, which are covered in the stock management section of this guide. Humanitarian agencies should resist the urge to use ground handling in all contexts despite its prevalent nature; commodities such as medication may benefit from not being stacked in a pile. Space planners should also resist the urge to fill up all available space when utilising ground storage; warehouses and storage facilities using ground storage and stacking should still observe the 70/30 rule, keeping lanes and aisles open for safety while making room for loading and offloading.



## Racking

Warehouse racking – sometimes referred to as pallet racking – is a heavy-duty metal superstructure that is specifically designed to hold large, pallet sized items. Each space where a pallet might fit is referred to as a pallet bay, and pallet bays are generally counted as “pallet positions” when counting warehouse space availability. Palletised cargo, bulky items stored on pallets, or oversized cargo of a specific size can be loaded onto pallet racking using a forklift. The bottom bay can usually be loaded with a pallet jack, or may kept open for hand stacking smaller items. Properly utilised racks can dramatically increase the storage capacity of a warehouse, maximising three-dimensional space to the best of its ability.

Pallet racks can be built to meet the floor plan and storage needs of a warehouse, and the cross beams upon which pallets sit are adjustable to match changing storage height needs. There are different types of racking system that can be considered in accordance with the storage requirements- Very Narrow Aisle (VNA), Selective racking, Drive-in/Drive through, Cantiliver, bins, and more - however any agency considering different options should consult with private companies offering installation and management services to better understand the requirements and needs of each. The vertical space between rack cross beams should be

reasonable; too high and space is wasted, too low and pallets may become stuck or cannot be properly inserted. An average height is around 1.5 meters, but adjustments may be required based on context of the pallet or items stored. Racks can be built to hold vertical stacks of pallets up to 20 meters tall, however racks should never exceed the safest lifting height of the available forklift on site, nor should they get closer than 2 meters from the ceiling. The horizontal frame depth between rack cross beams should not be wider than the expected pallet type to prevent pallets falling through, and irregular shaped objects may not rest neatly or safely without an additional flat surface resting across the two beams.

Pallet racking systems should only be installed by professional companies with demonstrated experience. Racking systems also require warehouse floors to be sufficiently thick and strong, as racks will need to be physical bolted to the ground. Racking must be safely operated around and maintained; physical racking structures must not show signs of distress, corrosion or damage. Compromised racking structures can easily collapse causing substantial loss to stored items and serious injury or death. Wherever possible, racks should have some form of physical crash barrier at corners of rows and lanes to prevent damage from handling equipment. Only persons trained and certified to operate a forklift should be engaged in loading and offloading cargo from metal racking structures.

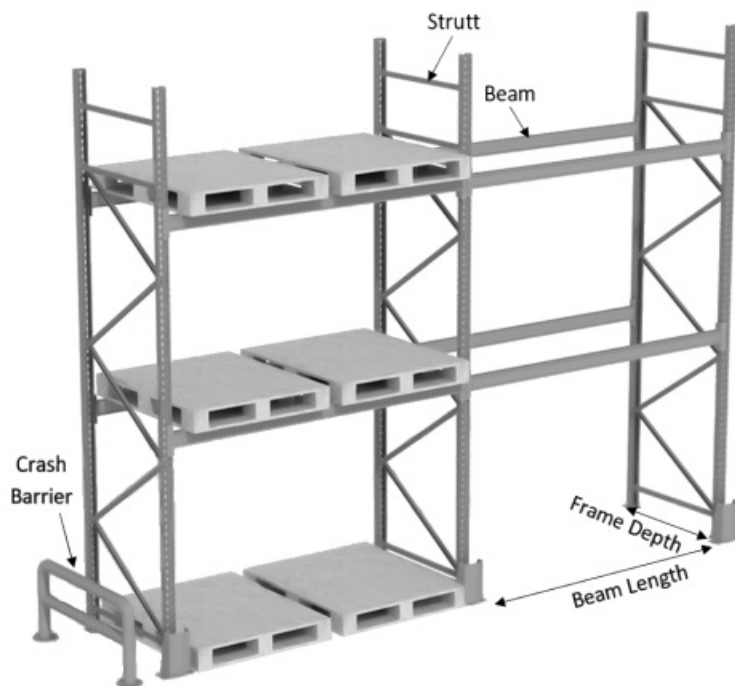

## Stacking Frames

Related to pallet racks, stacking frames are pre-made metal super structures that are designed to vertically stack cargo. Unlike pallet racks, stacking frames are free-standing, and are highly customisable and modular.

A single stacking frame is typically cubic in shape, and around 1.5 x 1.5 meters at the base, though sizes vary. Most stacking frames can either be nested into each other when not being used, or even be taken apart, saving space. Stacking frames are useful for:

- Stacking irregularly shaped cargo.
- Warehouse space with constantly changing racking needs.
- Quickly moving entire racks from one place to another.

If loose cargo is stored in the racks, it should be properly braced, secured, or wrapped. The entire frame can be moved by a forklift, and frames can be easily stacked as high as safely possible to take advantage of vertical space. Unfortunately, stacking frames can only be used in warehouses with smooth and stable floors, and where forklifts can safely operate. Many larger facilities use stacking frames to augment racking and shelving, especially for irregular shaped items that cannot be easily stacked otherwise.



## Pallets

Pallets have become ubiquitous across transport and warehousing operations globally, however there is a wide variety of sizes, dimensions and physical construction of pallets. Though local warehouse managers may have very little control over the types of pallets that might arrive, an understanding of pallet differences can assist with both space planning, and safe utilisation of racking and MHE.

Pallets generally come in a few standard dimensions. ISO Pallet Standard Dimensions are:

Dimensions (Metric)		Dimensions (Imperial)		Floor Space (Square Meters)	Region Most Used In
W (mm)	L (mm)	W (in)	L (in)		
1016	1219	40	48	1.2	North America

1000	1200	39.37	47.24	1.2	Europe, Asia
1165	1165	45.9	45.9	1.4	Australia
1067	1067	42	42	1.1	North America, Europe, Asia
1100	1100	43.3	43.3	1.2	Asia
800	1200	31.5	47.24	1	Europe

Both the square meters and side dimensions of pallets have implications for how pallets consume floor space in warehouse and trucks, how pallets may fit through doors, and how a pallet might be stored in elevated pallet racking. In addition to differing dimensions, there are different body constructions and different materials used in building pallets. Common pallet constructions:

**Two-way entry pallet - close boarded, no base board**



**Four-way entry pallet - perimeter base**

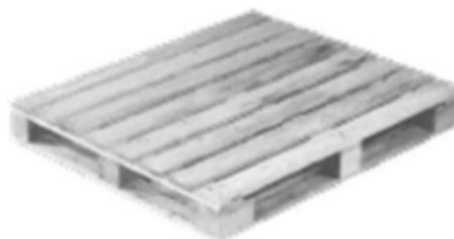

**Four-way entry pallet - close boarded, 3 base**



**Two-way entry pallet - reversible**



**Four-way entry pallet - close boarded, perimeter base**

**Four-way entry pallet - open boarded, 3 base**

---

**Two-way entry pallet - close boarded, no base board**



**Four-way entry pallet - perimeter base**



**Four-way entry pallet - wing type**

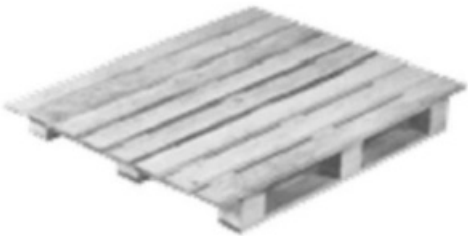

**Two-way entry pallet - wing type**



- 
- Pallets come in either two-way entry or four-way entry, meaning forks can lift from only two side or all four sides.
  - Pallets can be reversible or non-reversible. Non reversible pallets mean only one side has a stable surface upon which cargo can be stored. Non reversible pallets are sometimes called "skids."

There may also be requirements for pallets to be fumigated, heat treated, or made of plastic. Pallets are predominantly made of wood, and different wood sources are more prone to infestations that can impact stored goods. Some countries even have regulations prohibiting the use and transportation of untreated wood pallets.

A printable guide to pallet dimensions can be [downloaded here](#).

## **Material-Handling Equipment (MHE)**

Material-Handling Equipment (MHE) is defined as any mechanised or manual machinery to assist with the movement of cargo, either around a warehouse or during the transport process.

Proper use of MHE requires not just the equipment, but the infrastructure to surround it. Pallet jacks, carts and some forklifts will only work on flat, hard and smooth surfaces. Some MHE – forklifts in particular – require external power such as diesel, natural gas or electricity. Without the ability to supply this external power to MHE that requires it, the MHE is essentially useless.

MHE is designed to do heavy lifting; it can help warehouse personnel move heavy loads but can also be very dangerous. Forklifts can easily hurt or kill workers, while a pallet jack may enable workers to move pallets far heavier than they realise, compromising the safety of others. While



utilising MHE, warehouse staff should be properly trained and use proper safety equipment.

MHE typically involved in warehousing operations might include:

**Forklifts** – A mechanised power loader capable of lifting full pallets and heavy equipment. Forklifts come in a variety of sizes to meet a variety of load needs, but generally come with an enclosed cab and a four wheel base. All forklifts will have a hydraulic or chain powered “mast” capable of extending and lifting cargo vertically. The height and lift capacity of the mast depends on the rating of the forklift, and more information can be found from the manual or manufacture website.

Depending on the make, forklifts can be powered by either battery, compressed gas, or diesel/gasoline. Forklifts are generally designed for either use inside a warehouse with even surfaces, or for all terrain outdoor use.



Before obtaining a forklift, humanitarian agencies should consider:

- The availability of skilled or licensed operators.
- The conditions in which the forklift will operate (indoor or outdoor).
- The available energy source required to operate the forklift.
- The space required to utilize in or around a warehouse.

---

**Pallet Jacks** – Sturdy, low centre push cart with forks capable of lifting a pallet a few centimetres off the ground. Pallet jacks are typically only powered by hand, using a hydraulic piston to gently lift and lower pallets. Pallet jacks generally require flat surfaces and only work indoors, but can assist with moving large loads quickly and with minimal effort.



---

**Rolling Warehouse Ladder** - Heavy duty, reinforced metal ladder that can be repositioned around a warehouse to enable workers to reach higher shelves/racks. These types of rolling ladders tend to have extremely sturdy and wide steps that enable workers safely and easily carry cartons and other handling units up and down. These types of rolling ladders typically only work on solid, smooth surfaces.



---

**Dollies** – Occasionally referred to as hand trucks, dollies allow for moving of stacked cargo without the aid of a pallet. Dollies can be useful for moving relatively small loads, such as a stack of cartons, or a single large item, such as a large roll. Many dollies are designed with heavy duty inflatable tires to assist with operating outdoors.



---

**Push Carts and Others** – There are a variety of other simple tools to facilitate the movement of cargo around a warehouse or between mode of transits. A very common tool is a standard push cart, however there are many variations on sizes and components, and users should select the support tools most useful to them.



---

**Basic Support Items** – Part of a properly functioning warehouse is the ability perform simple maintenance, conduct routine product inspection and address small issues without having to source external support. Basic tools and support items that should be available in any warehouse include:

- Weighing scales.
- Measuring equipment – tape measure or yard stick.
- Sturdy ladders and step stools.

- Rope, twine, plastic binding, and sturdy wire.
- Packaging tape and duct tape.
- (if required) Plastic pallet wrap.
- Cleaning supplies – broom, bucket, mop.
- Face masks and gloves.
- Ear and eye protection.
- High-visibility vests.
- Heavy-duty pens.
- Note pads and writing materials.
- Safety knife and scissors.
- (if required) Industrial fans.
- Chairs and folding table.

A warehouse working with large MHE and palletised cargo will have some different needs than a small field level warehouse. Additionally, larger facilities may have contracts with professional cleaning or repair companies, while smaller facilities will be purely self-managed. The basic tools and equipment of a warehouse should reflect the daily needs of the operation, and the prevailing environmental conditions. Planners should think through their basic supply needs when establishing a warehouse; an overabundance of basic tools may cost more, but a lack of tools can stop an operation entirely.

### **The Cargo Handling "Human Element"**

In the context of humanitarian field operations, cargo is either heavily or exclusively moved and loaded by hand. Humans are far more versatile than typical MHE, including being able to achieve specialty tasks, however there are also limitations to human labour. Logistics personnel tend to calculate needs of warehouse handling based on the maximum performance of hand loaders and ignore the fact they have limitations like anyone else. When working with or scheduling hand loaded cargo operations, a good practice is to remember:

- Hand loaders require “recharging” periods such as water breaks or meals.
- Resource planners may need to factor prayer times into warehouse activities.
- People get bored with repetition which may increase mistakes.
- The overall efficiency and speed of hand driven operations will go down over the period of a day.

Injury and strain are common in warehouse operations, and human managed operations must acknowledge risks and needs of any tasks.

### **Warehouse Safety and Security**

When establishing any warehouse or storage facility, adequate physical security measures must be enacted. In humanitarian contexts, relief supplies are incredibly attractive to thieves – often humanitarian supplies are in short supply and the chaotic environments and limited infrastructure make theft frequent and hard to trace. Additionally, the overall operating environment may make responding to injuries caused in the workplace difficult. Aid agencies should have solid measures in place ensure a safe and secure workplace for stored items and workers.

**Perimeter Security** - Storage facilities should have in-tact perimeter walls or fences. The perimeters should not have any gaps or holes, and be high enough and sturdy enough to sufficiently prevent casual thefts or easy access. The perimeter areas should be as shaped as regular as possible to avoid potential blind spots where unauthorised access may occur. If

possible, sufficient perimeter lights should be installed, and should function throughout the entire night.

**Guard Service** - The warehouse ideally should have some form of guard service, either privately managed or sub-contracted through a third-party company. Guard services should have sufficient numbers to cover all hours of the day and night with regular 8-10 hour shifts. Having one or a few live-in guards may mean guards reach fatigue and/or won't be alert at all times, especially throughout the night. Any guard service should also control the flow of visitors and vehicles through use of sign in/out sheets, and possibly even the need to ask for permission before letting outsiders in. Guards should also perform routine perimeter checks, looking to see if doors have been compromised, and responding to any suspicious noise or activities.

**Fire Suppression** - Warehouse and storage facilities of all sizes should have a fire suppression plan in place. Larger facilities may have professionally installed smoke detector and sprinkler systems in place. Sprinkler systems should be regularly inspected by a licensed company, and in compliance with national laws where required. Smaller or remote warehouses may not have the infrastructure or the available utilities to support an advanced fire suppression system, and should be outfitted with basic fire-fighting tools.

Irrespective of the warehouse space, fire extinguishers should be readily available. Fire extinguishers should be clearly visible to the eye, easily accessible, and be placed at least every 25 meters or closer if required by local regulations. Extinguishers should be inspected every 30 days to ensure the pressure valve reads as in the workable range, and that the canister does not display symptoms of rust or corrosion, and that the hoses are not split or damaged. At least once a year, extinguishers should be pressure tested. If at any time extinguishers do not pass inspection, they should be recharged or replaced as necessary. Consult the owner manuals or supplier for proper gauge readings.

At bare minimum, class A extinguishers should be placed throughout the storage space at the correct intervals, and class B extinguishers should be stored near any place reactive substances or flammable liquid such as fuel are stored. Many field location will also use what are known as "sand buckets" - buckets pre-filled with sand and stationed throughout the facility to also enable rapid suppression of a fire. Both are recommended for remote locations where water may be scarce and proper maintenance of extinguishers may be difficult.

Fire Extinguisher Classes Per Region:

American	European	UK	Australian/Asian	Fuel/Heat Source
Class A	Class A	Class A	Class A	Ordinary combustibles
Class B	Class B	Class B	Class B	Flammable liquids
	Class C	Class C	Class C	Flammable gases
Class C	Unclassified	Unclassified	Class E	Electrical equipment

American	European	UK	Australian/Asian	Fuel/Heat Source
Class D	Class D	Class D	Class D	Combustible metals
Class K	Class F	Class F	Class F	Kitchen Grade (Cooking oil or fat)

**Occupational Safety** – Warehouse workers should be instructed and encouraged to engage occupational safety in any situation where storage is required. Occupational safety includes:

- High visibility vests worn by warehouse workers and visitors as needed.
- Warehouse workers have sufficient and adequate breaks.
- MHE is properly maintained, and support equipment such as ladders is not compromised or damaged.
- Staff who operate MHE are trained and/or certified for that equipment where required.
- Stocked first aid kits available on site.
- Warehouse workers wear proper protective equipment equivalent to the required working conditions, including gloves, hard hats/helmets, close toed safety shoes, ear and eye protection as required.
- Fire exits are clearly marked.
- Lanes for movement of MHE are clearly marked on the floor.

**Situational Safety** – As the storage site is established, agency security personnel conduct periodic reviews and follow incidents accordingly. Safety and security assessments of the warehouse and the surrounding areas should be conducted at least once a year, and security incidents occurring on site or in the immediate area should be properly reported in a timely manner.

## Physical Storage Guidelines

Irrespective of the size of the warehouse/storage facility or nature of the storage arrangements, there are basic rules humanitarian organisations can use to enhance their physical stock management processes.

In any situation where cargo is stored for any period of time, it is strongly advised that humanitarian warehouse managers utilise both some form of inventory Ledger and a paper stock/stack/bin card system.

An ideal inventory Ledger will be electronically maintained, utilising some form of spreadsheet or special use software. The ledger should be constantly kept up to date, and should be easy to access and understand by any team member responsible for accounting for cargo on site.

Stock/stack/bin cards should be clearly visible from the floor of the warehouse, legible, easy to read, and utilise the local language of operation. Stock/stack/bin cards should match the inventory Ledger.

Stock managers must by default practice FIFO – First In / First Out – unless otherwise required to. Some storage facilities may have large volumes entering and leaving the physical facility, and managers must take care to ensure that old stock is not forgotten or ignored.

Perishable items with expiration dates must be closely tracked and dispatched in accordance with the practice of FEFO - First Expired / First Out. Items with expiration dates less than three months in the future or expired items should be flagged and communicated to program staff to ensure they are properly utilized.

Stored cargo must always be separated from the ground, using pallets, tarpaulin, shelving, or racking. Warehouse managers should be constantly monitoring the status and condition of stock on hand. All handling units should appear in good condition, and be free from avoidable damage of any kind, including water damage, punctures or rusting. If cartons or items appear to be crushed, punctured or experiencing damage from regular wear and tear, they must be separated, repaired (if possible), and returned to inventory in a manner that prevents future damage.

## **Stock Counts**

There are a variety of methods for [conducting physical inventories](#). Agencies should review different inventory methods, and set up guidelines and time intervals for conducting inventories, including ad-hoc and regularly scheduled annual inventories.

## **Damaged Items**

Throughout the course of managing physical stock, damaged items will be discovered, either as a result of age, expiration, mishandling, or even from items that were defective in the first place. As damaged items are discovered, they must be clearly marked and addressed. Some damaged items can be repaired, especially if damage is only to outer packing. An item that is ultimately still usable, but has damaged outer packing can be repacked into new cartons/bags where available, the packaging itself can be taped or sealed. Even if there are no replacement cartons/bags available, the usable items can be stored loose on the racks/shelf/stack and be marked for usage first during the next pick order.

If the core item is ultimately not usable due to extensive damage, spoilage or expiration, the item will need to be separated from the rest stored goods. Damaged goods should be clearly marked, and stored in a separated area. Depending on the severity of the damage, a loss report may need to be generated, including the number of units damaged and the associated values. As damaged items are removed from the general inventory, inventory Ledgers should be fully updated, with damaged items clearly indicated as being deducted from the full inventory count.

Damaged items may need to be returned to a vendor, handed over to third party authorities, or be disposed of.

## **Expiration Management**

Under normal circumstances, warehouses are advised not to accept goods that have less than 6 months expiry period left, and should seek to rotate out items approaching 6 months left before expiring. Warehouse/stock managers should routinely generate regular reports that identifies those items that are due to expire within a user specified period, identifying each SKU, lot, quantity and date of expiry.

## General Expiry Management Rules

---

### **Ordering Items**

Incoming orders that contain expiration dates should be flagged and notified to the warehouse teams, and shared with relevant persons or departments that own the stock.

---

### **At Reception**

All incoming stock items should be inspected for expiration dates at the point of reception.

---

### **Ongoing Physical Checks**

Checking expiration dates should be part of the physical inventory process, including looking for new expiration dates not already identified in the stock/inventory tracking system.

---

### **Items with 1-3 Months Expiry**

Persons or departments storing Items with expiration dates should be notified when they reach 1-3 months left until expiration on a weekly or monthly basis, through email or other formal communication.

---

### **Items with 0-1 Month Expiry**

For items with less than one month until expiration, it is advisable to notify the person or department that owns the stock - either in person or telephone - reminding them of the situation and suggesting that the goods are removed as soon as possible. Multiple reminders may be required.

---

### **Expired Goods**

Any items that have expired must be segregated from the rest of the stock, and all orders put on hold so that no expired items are accidentally delivered. The person or department that owns the stock must be notified by phone, email or in person, and all proper disposition steps must be followed in accordance with local regulations and organizational policy.

---

## **Disposition**

As warehouses continue throughout their operations, they will inevitably need to dispose of damaged, expired, recalled, or no longer required goods. Disposition of any item must be done in an ethical, environmentally friendly and legal manner, all in compliance with the internal policies of the organisation managing the facility. Options for disposition:

## General Disposition Management Rules

---

**Donation/Resale** Items still in usable condition can be sold or donated to other agencies or local populations in accordance with donor regulations and internal financial policies.

---

**Dispose** Some items can be thrown directly into the trash without concern, such as small quantities of expired food stuffs or cardboard.

---

**Destroy** Some items, such as expired medication, harmful chemicals, bulk foodstuffs, and special “dual use” or military grade hardware, may need to be actively destroyed. Many local authorities have regulations on the destruction of these items, and there may even be authorised companies certified in destroying key materials. Agencies should investigate local laws and seek out disposal companies whenever required.

---

**Re-export** Items, such as heavy machinery, may need to be re-exported from the country of operation. Re-exporting of key items may be required by donors and national authorities, or may be just more cost effective than local disposition.

---

## Warehousing Documentation

The documentation requirements for warehousing can be vast, depending on the type of warehouse, regulatory controls over the stock or the facility, the types of commodities stored, or the specific activities of the agency running the facility. Documentation might include inspection reports, fumigation schedules, repairs, import/export documents related to bonded storage and more.

As an overview, most humanitarian agencies will use at least several standard documents across all of their storage operations, including large professional facilities all the way down to field level storage. These documents are essential for the proper audit and tracing of cargo as it flows in and out of agency managed facilities. It is important that this standard document be accurate, and that copies are properly kept – both at the site of operation, and eventually scanned/backed up in another location for wider historical record keeping.

**Waybill/Delivery Note** – Warehouses will often use common waybills as part of the overall documentation process. Waybills – also sometimes called “delivery notes” - come in many formats, and can represent either domestic or international deliveries. Waybills also tend to be generated by external third-parties, and are used for their own third-party tracking needs. If properly handled, at least one copy of the incoming waybill should stay with the receiving party (warehouse). If a copy cannot be left with the warehouse, the receiving warehouse should attempt to electronically scan a copy of the waybill, including all signatures and notes on it as evidence of delivery.

As cargo leaves the warehouse, waybills will also be generated. Agencies may wish to generate their own agency specific waybills to accompany cargo they pack and load. In other situations,

third-party vehicles may generate their own waybills on the spot. In either case, warehouse workers loading cargo onto vehicles must ensure that the information contained on the waybill is accurate. Situations in which organisations may choose to use self-generated waybills may include:

- The vehicle is managed/owned by the agency.
- The destination of the vehicle is a facility or distribution site managed by the agency.
- The contract with the third-party trucking company stipulates that they must use agency specific waybills.

**Goods Received Note (GRN)** – Some form of GRN is typically generated at the point of reception into a warehouse facility. A GRN will theoretically contain the same information on incoming shipments as a waybill, but a GRN serves a few key functions:

- A GRN may capture information on multiple consignments arriving at once.
- GRNs may take the place of waybills, which may show up with incomplete or incorrect information, or may not come at all.
- GRNs are a form of standardising incoming information in the format most useful to the organisation.
- With proper planning, a GRN can be generated prior to a shipment arrival so warehouse crews know what to expect at the point of offloading.

GRNs should capture dates, locations, persons involved in the transaction and the contents of the cargo entering the warehouse. The exact structure, contents and sequence of a GRN vary depending on needs – as an example, an organisation focused on medical interventions may need to track batch and lot numbers, while an organisation focused on food may choose to track items by the kilogram. Organisations should consider their own internal requirements when drafting a GRN.

Example [GRN](#):



ORGANIZATION  
LOGO

# GOODS RECEIVED NOTE

Received Note No.: \_\_\_\_\_ Date: \_\_\_\_\_

Location Received At \_\_\_\_\_ Related to PO No. (if applicable) \_\_\_\_\_

Person/Company/Organisation Received From \_\_\_\_\_ Total No. Packages \_\_\_\_\_

Waybill No. \_\_\_\_\_ Total Volume \_\_\_\_\_

Delivery Method \_\_\_\_\_ Total Weight \_\_\_\_\_

Unit Type (carton, piece, etc)	Item Description	Number of Units Received	Number Received Damaged	Lot / Batch / PL No.	Condition

Remarks:  
\_\_\_\_\_

\_\_\_\_\_  
Name of Person Receiving \_\_\_\_\_ Signature of Person Receiving \_\_\_\_\_

\_\_\_\_\_  
Name of Person Delivering \_\_\_\_\_ Signature of Person Delivering \_\_\_\_\_

Title  
Template - Goods Received Note (GRN)  
File  

**Goods Release Note/Stock Release Order** – A goods release note serves a similar function as a GRN, however a release note’s goal is to capture the information on items as they leave the warehouse. Many organisations choose to use the release note the same as an official pick-order; the requesting party initiates the release note indicating which items are required, and obtains counter signature from the appropriate entity within the organisation. A completed release note will capture the final dates, quantities and persons involved with the loading all the way to the truck. A proper release note will tell a story of what was removed, why and by whom. Many agencies don’t actively use release notes, opting to only use waybills at the time

of release or communicating pick-orders via email.

Example [Release Order](#):

<b>ORGANIZATION LOGO</b>		<b>RELEASE ORDER NOTE</b>		
Release Order No.: _____		Date: _____		
Location Released From _____		Total No. Packages _____		
Waybill No. _____		Total Volume _____		
Delivery Method _____		Total Weight _____		
Number of Units	Unit Type <small>(carton, piece, etc)</small>	Item Description / SKU	Project Intended For	Condition
Remarks:				
Name of Person Requesting Release _____		Signature of Person Requesting Release _____		
Signature of Person Issuing Goods _____		Signature of Person Issuing Goods _____		
Name of Person Receiving Goods _____		Signature of Person Receiving Goods _____		

Title  
Template - Goods Release Order  
File  

**Stock / Stack / Bin Card**– A stock card is a physical, hand written record that stays alongside the corresponding physical cargo inside a warehouse or storage facility. Stock cards are sometimes referred to as “stack cards”. The nature of the tracking stock card does not change, however – its purpose is to trace the history of the physical consignment in a quick and easy to reference manner.

Example [Stock Card](#):

**ORGANIZATION  
LOGO**

# STOCK CARD

ITEM INFORMATION					
ITEM DESCRIPTION		SKU OR PRODUCT CODE		HANDLING UNIT	
PROJECT			EXPIRY DATE	BATCH #	
DATE	FROM / TO	IN	OUT	BALANCE	REMARKS

This record is not to be destroyed

A stock card should at the bare minimum include:

- The item description.
- Any consignment or procurement relevant information.
- Dates and quantities of cargo items received.
- Dates and quantities of cargo items released.
- Running total balance.

Certain types of goods requiring more meticulous control and analysis, may and need to be tracked using stock cards with specific information, including but not limited to:

- Project or donor earmarks.

- The SKU code (if available).
- Relevant product info - Expiration dates, batch numbers, lot numbers, date of manufacture.
- Reorder threshold.
- Manufacturer references.
- Temperature control requirements.

The stock card has inventory control purposes and is normally managed by the store keeper and updated immediately with each stock movement, including losses. The use of stock cards is imperative in all warehouses, even if the number of articles is short or there is limited rotation. In an ideal context, any warehouse worker on the floor should be able to quickly reference a stock card for the most up to date information on the status and flow that specific good in a warehouse. Quantities and dates on stock card should also match the quantities and dates on a inventory Ledger, GRNs and waybills.

For some items, bin cards can be introduced. These may have a similar format as the stock card but are fixed to the bins or shelves where the items are kept. Bin cards track movements of an item stored in a particular bin, shelf or stack. Bin cards are used when big quantities of the same item are stored, requiring some kind of grouping, easing handling, picking and counting processes.

Title

Template - Stock Card

File



**Inventory Ledger** – A inventory Ledger is defined as any system that keeps a running history and current total of all cargo items in a storage facility, as well as all relevant information (expiration dates, donor information, etc). The inventory ledger also tracks inventory transactions (receptions and dispatches) in terms of quantity and value based on the information from the corresponding transaction document. This tool has accounting purposes and is normally managed by an accountancy person and updated in a regular basis (weekly, monthly).

There is no one standard for a inventory Ledger system. Historically, running inventory Ledgers were recorded by hand in a book, but modern systems may use computer-based spreadsheets, specially designed software, web-based tracking, and more. The important part is that a warehouse manager can quickly and on-demand find relevant information for any stock item contained in the warehouse through a single centralised system.

Templates of warehouse goods flow documentation can be found in the [reference section of this guide](#).

## Goods Flow Management

### Planning Reception

In an ideal cargo reception process, incoming shipments should be arranged prior to the delivery vehicle arriving and information on incoming shipments should be communicated to the warehouse team in advance. Ideally, the consignment contents and volume, and possibly even a scanned copy of a packing list and/or waybill will be communicated in advance as well.

- If a single organisation is moving cargo between two warehouses/storage locations it

directly manages, it should be relatively easy to provide advanced delivery information to the receiving location.

- If the warehouse in question is receiving cargo from outside sources such as a vendor, agencies should endeavour to obtain as much information as possible up front.
- In any situation, vehicles approaching the warehouse or storage facility should be instructed to call at least one hour in advance to ensure the warehouse can adequately receive and offload the vehicle. In storage facilities with busy operations, the vehicle will need to be scheduled for a specific time for offloading.

## At Cargo Reception

Steps to take at the point of receiving cargo into a warehouse facility include:

- The weights and volumes for each line item are recorded.
- Full count is conducted against the waybill. Discrepancies between the piece count and the waybill or damages should be noted on the waybill.
- All incoming items should be inspected.
  - Items with expiration dates should be recorded on both stock cards and the warehouse ledger, and compared against any purchase orders or packing lists.
  - Dangerous items should be properly recorded on stock cards and the warehouse ledger, properly labelled, and properly segregated according to their storage needs.
- A goods received note (GRN) for the received items is generated.
- Items are placed in appropriate, corresponding place in warehouse/stock room.
- Physical copies of the GRN and Waybill are backed up in a secure location in the office warehouse.
- As items are placed in the warehouse, stock cards should be updated. If no stock card yet exists, a new stock card should be generated.
- Shipments arriving without prior notification may be rejected, depending on security, warehouse capacity and policy of the organisation.
- If damaged or expired items are received, the items should be rejected and returned if possible. If not possible to reject items (internal transfer) damaged or expired items should be separated from the main consignment and placed in a well-marked location, to be repaired or disposed of later.

## Planning Dispatch

Much like planning cargo reception, there are steps that warehouses and organisations can take to plan for cargo dispatch as well:

- Cargo dispatch should be planned in advance and communicated to the warehouse.
  - A formal release order should be authorised, and relevant warehouse staff be issued a formal pick order
  - Warehouses should be given time to pull down cargo, compile shipments, and stage for pick up.
- If at any time a dispatch is not possible (damaged, expired items, or item cannot be found) the requesting party should be notified, and the release order modified.
- Vehicles arriving for pick up should be known and scheduled in advance. Vehicles arriving for unplanned cargo pick-ups, or arriving announced for planned cargo pick-ups may be delayed or rejected based on the policy of the managing organisation.

## At Cargo Dispatch

Steps to take at the point of releasing cargo from a warehouse facility:

- A physical piece count on the consolidated cargo is conducted to confirm correct number.
- A waybill or a goods released note is generated (if required by the terms of the movement), containing information on the released cargo, dates, and names of person releasing and driver picking cargo up.
- Stock cards and inventory ledger updated with the new piece counts.

## **Ground Storage / Stacking**

Ground storage and stacking is extremely common in humanitarian warehousing operations, especially in field settings near the final distribution points. Storing cargo on the ground and/or in stacks has become a default, largely because the necessary infrastructure to manage special warehouse equipment of storage solutions isn't always available, there are limited skill sets available in the local market, and many of the smaller field warehouses are by nature transitional.

In NFI operations, stacking can be challenging. An average humanitarian program can have dozens of individual SKUs to fulfil a variety of programmatic needs. With an increased number of SKUs, maintaining large piles of cargo can make identifying and managing individual cargo items difficult. There are several mitigation measures agencies can take when faced with generating cargo stacks in a warehouse.

Cargo stored on the ground or in stacks should always be clearly demarcated. A stock card should physically accompany every stored SKU item, and warehouse managers should be able to quickly identify and pick orders without having to sort through piles of non-related items.

## **Cartons/Bales/Sacks**

Wherever possible, stacked cargo should be stored in as uniform manner as possible for quick counting and identification. To facilitate this, warehouse managers must:

- Identify the pallet configuration; single pallet vs. multiple pallets pushed together on the ground.
- Plan a "layer" system for the stack. Each layer and row of carton/bale/sack should have the same number of handling units.
- Start with a base layer on the lowest level first. Once the lowest later is complete, repeat the second layer in an interlocking pattern for stability.
- Plan stack layers for like item units only. Avoid stacking/layering different items/SKUs.
- Ideally, plan to keep only units from the same consignment in the same stack.
- Cargo should only ever be removed from the top layer to avoid instability.
- Cartons/bales/sacks should not be leaning off the edge of the pallet.

## Proper Layered Stack

---

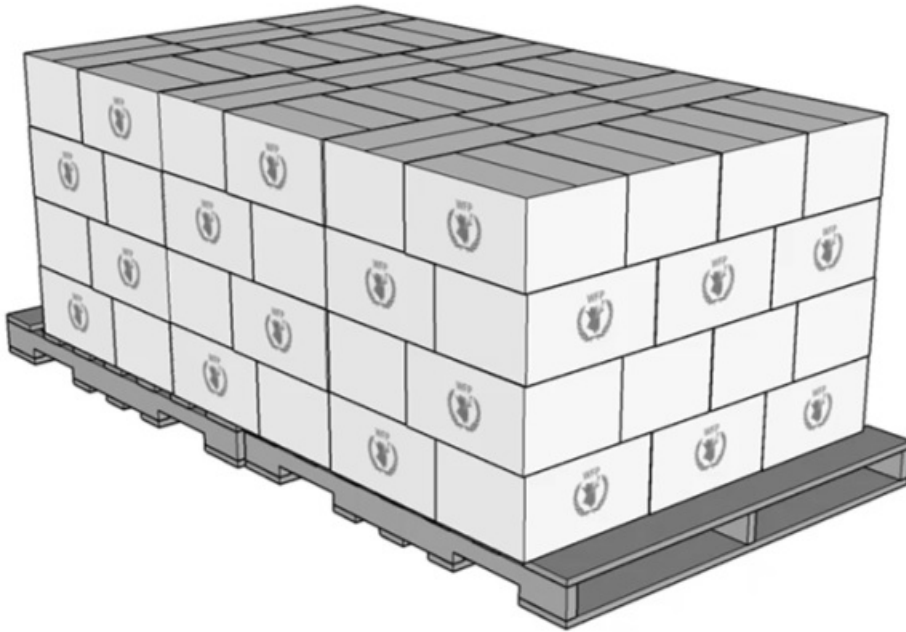

---

Stacked cargo should be stored as safely as possible. Stacks should be layered in interlocking patterns; a non-interlocking stack is far more likely to fall over and/or put pressure on the lowest layer of cartons. Partially empty cartons should not be stored at the bottom of the stack to avoid the lowest levels from caving in and causing the stack to collapse.

**Do Not Use on Lowest Layers**

**Non-Interlocking Stack**

---

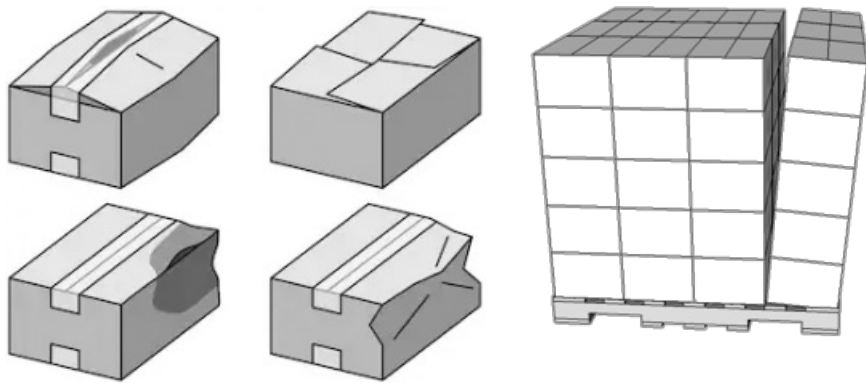

There are multiple varieties of alternatives for stacking loose cartons and irregular shapes. The configuration will depend on the commodity itself, the space requirements of the warehouse, and the speed and skill of the warehouse staff. Some possible configurations might include:

**Block Stack**

**Brick Stack**

**Pinwheel Stack**

**Irregular Stacks with Separators**

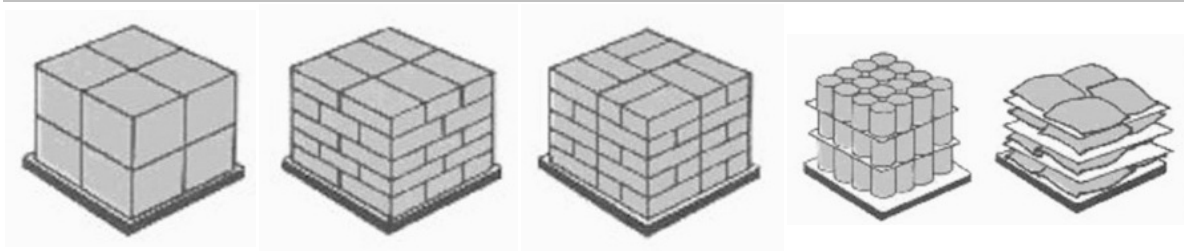

Many ground stacking operations also utilize what is called "pyramid stacking." Pyramid stacks are useful for durable, bulky items and in contexts when high volumes of uniform items need to be stored in a relatively small space. Pyramid stacks - sometimes also called "stair stacking" have interlocking layers with reduced diameters the further up the stack goes. The pyramid shape prevents dangerous items from falling, and may make accessing the top layer easier for hand loaders.



## Pyramid Stack

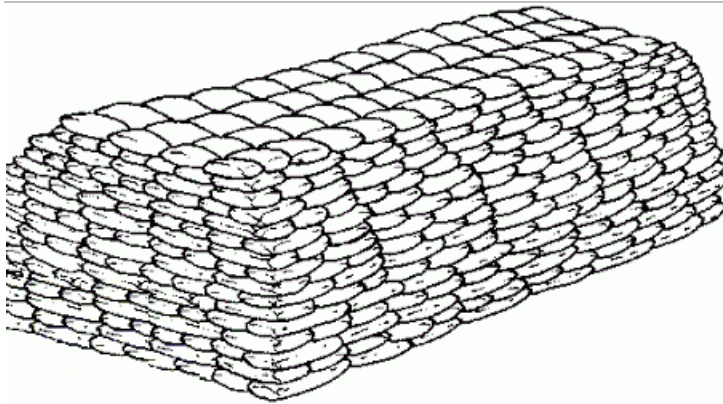

---

No matter what the stacking configuration looks like, stacks should not be stored above an unsafe height.

- A safe height may be context specific; for NFI cartons/bales/sacks of any size that are heavy enough injure workers, stacks should never exceed 2.5 meters, while light voluminous items such as empty plastic jerry cans might be stored higher if required.
- Food bags, blanket bales or sacks of concrete can be stored in pyramid stacks, however pyramid stacks should still only be made as high as is contextually safe.
- No matter the height, warehouse workers should be able to safely withdraw cargo from the top layer without risk of falling or causing the stack to collapse.
- A stack should not surpass a ratio of 3:1 - the height cannot be 3 times the horizontal width of the base.
- Stacks should never be so high that they come into contact with the ceiling, and at least half a meter space should be left between the top of the stack and the ceiling for accessing items as needed.

Stacks should never exceed 6 meters in length, or a maximum floor space of 6 x 6 meters. Excessively wide or large stacks can cause multiple problems:

- Spoiled or damaged items in the middle are difficult to spot or deal with.

- Practising FIFO/FEFO may be difficult if cargo in the middle of a large stack is inaccessible.
- Visual counting may be difficult or impossible.
- Excessive weight in a single area of the warehouse may lead to structural risks.

Stacked items should not be slumping or falling over. Crushed or damaged units at the bottom of stacks should be addressed immediately; crushed items should be moved to the top of the stack, and if possible/necessary, reduce the height of the stack to prevent further damage.

## Cylindrical Items

Ground storage of cylindrical items must be done in way to prevent items from rolling or falling. Ideally, items like tires and metal drums should be stored with their flat surfaces facing downward on a pallet or tarp. In some cases, cylindrical items may not be able to be safely stacked on their flat surfaces due to height restrictions, weight concerns, or the overall dimensions of the item – in which case guard barriers can be built outside the pallet or floor storage to keep the items in one place. Any guard barrier should be strong enough to contain the weight of the combined items.

**Cylinders Stored Upright**



**Cylinders Braced/Stored on Side**

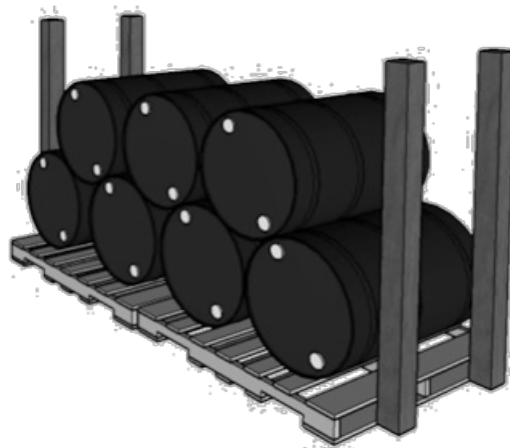

## Timber/Lumber

Loose timber and lumber are commonly stored throughout the humanitarian sector. Timber should:

- Ideally be stored outside in a covered space.
- Separated by type/length/requirement.
- Be easy to count.

Thought it may be tempting to stack timber in a pile, dense piles of wood can lead to infestation or rot, and make proper accounting very difficult. To facilitate timber management, solutions might include:

- **Bundles** - Bind lumber/timber items into uniform bundles with identical piece counts. This will speed up counting, and make bulk moving of lumber/timber faster. Bundles are opened one at a time to facilitate pick orders. Bundles should still remain a reasonable

size, and not be so large they break their bindings.

- **Layer Stacks** - Stack lumber in uniform, interlocking patterns, much like laying layers for a stack of cartons/bales/sacks. Laying an interlocking pattern requires defining a base layer, and then repeating the same number of units on the next layer, and so on. The interlocking pattern allows for ventilation, something bundling cannot. An interlocking pattern of lumber/timber will always result in a fairly large foot print however, so stacking is only recommended when outside storage isn't an issue.

**Lumber Stored in Bundle**

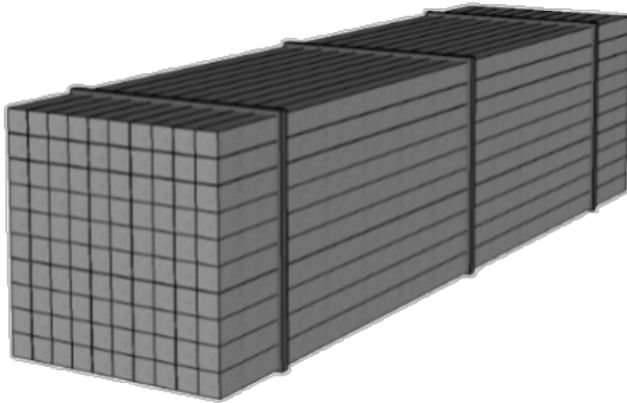

**Lumber Layer Stacked**

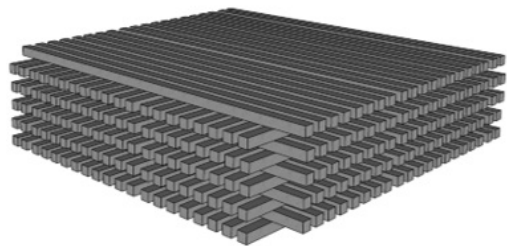

## **Double Stacking Pallets**

Double stacked pallets are defined by one or more pallets placed on top of each other without the additional layer of a pallet rack or support structure. Double stacking is fairly common in transport, but should be avoided for any form of medium to long term storage in warehouses. A double stacked pallet can easily fall over and injure warehouse workers if any part of the bottom pallet is compromised, often without warning. A collapsed double stacked pallet can also easily destroy the contents of one or both of the individual pallets. With the inconsistent flows and constant changes of a humanitarian supply model, a double stacked pallet may end up being stored for much longer than originally planned, and managers may forget or simply not realise the dangers of double stacking.

## Double Stacked Pallet



---

## Elevated Storage

### Pallet Racking

Cargo stored on pallet racking has advantages and disadvantages. Though use of pallet racking affords the efficient use of vertical space and rapid movement of large volumes of cargo, users of pallet racking sacrifice the ability to manage cargo at the unit level, instead having to work mostly with palletised cargo.

When managing cargo using pallet racking, pallets should be properly stacked and loaded. Ideally, only like items and/or items with the same SKU will be stored on the same pallet, and pallets containing the same SKUs will be stored next to each other on the same racks. Cartons and cargo on pallets should be uniform and even, with weight evenly distributed across the

pallet to avoid accidents while moving using a forklift. Cartons or items on a pallet should also not stick out over the edge of the pallets to maximise the use of space on the rack.

### **Improper Palletisation**

### **Proper Palletisation**

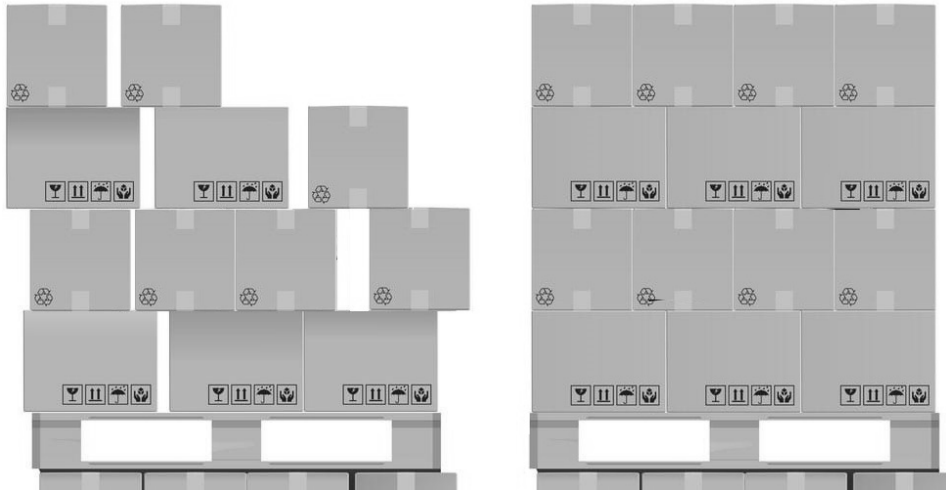

Ideally, pallets should also be well wrapped to prevent slumping or falling during movement and long-term storage. Pallet wrapping is cheap and widely used, and can be done by hand without the need for special equipment. Some products and warehouses also choose to utilise binding – synthetic or organic ropes or straps – that keep palletised cargo together. Properly wrapped or bound pallets will dramatically increase the longevity of the pallet.

### **Pallet with Plastic Wrapping**

### **Pallet with Plastic Binding**

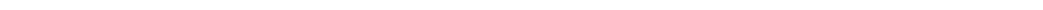



---

Other general guidance points for utilising pallet racking systems:

- Pallets stored on racks for long periods of time may start to slump or display distress. Pallets appearing compromised must be pulled down, rebuilt/re-stacked and re-wrapped.
- Racks should be numbered for easy reference, including the row number and the level of the racking.
- Items most frequently accessed should be stored in the lower level of pallet racks. More infrequently accessed items should be stored on higher racks.
- Extremely heavy, bulky or expensive items requiring rack storage should be stored on the ground floor of pallet racks to avoid injury while loading or damage to goods.
- Pallets should be clearly labelled denoting consignment information, and should be legible from the ground and at any angle.
- If stock cards are used, they should be kept at ground level in a safely accessible area.
- The rows between racks should be separated far enough to allow for manoeuvring of handling equipment.
- Pallets should be adequate width to sit on the cross beams without risk of falling through.
- Pallets stored next to each other on pallet racks should not come into physical contact.
- Pallets should be evenly balanced across the beam; no pallet should be leaning over the edge of the frame, nor sticking out too far.
- Pallets should not exceed the weight limit of the racking.

- Loading and offloading of racks should only be conducted by a trained professional.

### **Pallet Rack Safely in Use**

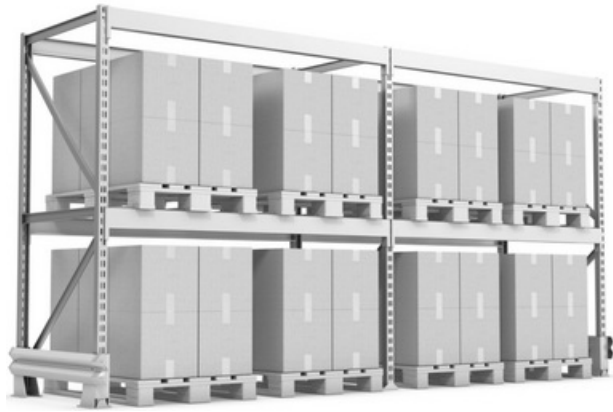

## **Shelving**

Warehoused items stored on shelving offers the quickest and most organised access to the lowest inventory unit. Where as ground stacking or pallet racking are meant for large scale storage of high volumes of items, shelving should be treated as a sorting point for individual items, much like items stored on the shelf a local store.

Shelving is ideal for items that are dispensed at low volumes, such as certain pharmaceuticals or communications equipment, or for high value or sensitive items. Shelved items tend to be very detailed, and many individual SKUs can be stored on a single shelf. For this reason, proper accounting is essential.

- Shelved items should have stock cards clearly visible and accessible. If shelved items are taken from a larger consignment in the warehouse, both the warehouse stock and the stock on shelving should probably be tracked on separate stock cards.
- Shelves should not be overloaded, and all items should be clearly identifiable and separated.
- Shelves should be clearly numbered for ease of reference.

As shelving tends to contain loose items or items at the unit level, there are a few tricks warehouse and stock managers can use.

- Fragile items such as glass vials can be stored on the bottom shelf to reduce the risk of accidental breakage if handling units are dropped or fall over.
- Liquids, powders and solids should be clearly separated. Liquids should be stored on bottom shelves, both because of their weight and because a ruptured package might leak on all items below it.
- Some like-items may still need to be separated. As an example - the same quantities and dosage of a single pharmaceutical may have different expiration and/or batch/lot numbers, or different items belong to different donor grants. Each item will need its own stock card and clearly defined space.

### Shelf with Loose Items in Use

---



---

## General Storage Guidelines

Below are general guidelines for the most commonly stored types of items in a humanitarian context.



**Medical  
Items**

- Boxes should not receive direct sunlight.
  - Temperature in the warehouse should be controlled and recorded daily, and fridge temperature should be controlled and recorded where cold chain items are stored.
  - Drugs should ideally be stored by type of drug: infusions, injectables, oral drugs, diagnostic tests, etc.
  - Always store medical supplies separately from chemicals or food (pesticides, fertilisers, cement, fuel included), and dangerous goods. This also applies when loading onto vehicles.
  - If stored on pallets, all cartons should be clearly labelled with their contents.
  - Always record batch numbers (found on the outer cartons and on each container of the drugs, allocated by the manufacturer) and expiry dates of medical supplies upon receipt and record batch references at all stock movements, including on all stock/bin cards and all warehouse ledgers.
  - It is good practice to track medical supplies on stock cards raised by batch number. Alternatively, you can record the batch number of the drugs as they moved in and out of stock.
  - Expired drugs are not fit for human consumption and should be destroyed safely. Contact your local Food and Drug Administration to enquire about the regulations around the destruction of medical supplies.
  - Expired or damaged drugs must be quarantined until they can be safely destroyed. Keep a record of drugs placed in quarantine on the relevant bin and stock cards.
  - It is advisable that all medical items be rotated following the FEFO (first expired, first out) principle.
  - Some national authorities require special licenses for the storage of drugs and medical supplies. Check with local authorities to find out what is required in the area of operation.
  - More information on specific guidelines for storage medical items can be found in the [health supply chain section](#) of this guide.
-

---

**Food Items**

- Food needs to be protected from sun, rain, humidity and extreme temperatures.
- Covered and protected storage space is always preferable.
- If uncovered and unprotected storage cannot be avoided, make sure outside storage is only temporary (maximum 10 to 15 days).
- Always store food separately from chemicals (including pesticides, fertilisers, cement, and fuel), dangerous goods and drugs. This also applies to when transporting items as well.
- If you are treating a warehouse that contains food against pests, make sure the chemical used is food-safe (consult your regional logistics support if you are unsure).
- Ensure the storage areas are cleaned daily, and that all cleanings are recorded (daily sweep, weekly clean and wipe-down, monthly deep clean).
- Pay particular attention to infestation signs
- Immediately separate and quarantine infested stocks from the rest. All infestations must be reported immediately to country managers.
- Expired food items must be quarantined and stored separately until they can be destroyed.
- Expired food must be disposed of immediately. Check with local health authorities to determine whether it can be used as animal feed or for the appropriate disposal method (incineration or burial). Be mindful that the destruction of food may sometimes cause strong cultural reactions.
- Pay particular attention to the reception process to confirm weight received: weigh five to ten per cent of the consignment and extrapolate weight of the full consignment to estimate total weight of the consignment against documented weight or use a truck weighbridge to compare the actual weight to the documented weight on the GRN/delivery note/waybill. Record any discrepancy on the GRN.
- Always record batch numbers and expiry dates of food items upon receipt and stock movement, including on all stock/bin cards and all warehouse ledgers.
- It is advisable that all food items be rotated following the FEFO (first expired, first out) principle.

---

**Construction Materials**

- Small parts such as screws, nails, turns and bolts are usually measured and accounted by weight rather than units.
  - For poles, sticks, metal bars and other long and/or bulky items, build “reference” storage areas, with items separated by quantity. For example, store wooden poles in bins with 100 pieces in each. This will help managing stocks per FIFO principles and avoid the deterioration of stock.
  - For sand, gravel and other loose materials, build tank storage per cubic metre to help track stock levels. A good option is to build one cubic metre “bins” and cover them to preserve the quality of the material.
  - The maximum height of a stack of cement should not exceed 15 bags, to prevent lumping from pressure.
  - Cement must always be kept dry and away from the walls of the warehouse. Ideally cover cement stacks with tarpaulin to protect the bags.
-

---

**Chemical Products**

- Chemicals can never be stored with food or drugs supplies.
  - Many chemical products are defined as dangerous goods – [dangerous goods should be identified and labelled/handled appropriately](#).
  - When conducting routine warehouse checks, check the packaging of chemicals thoroughly for wet cartons, chewed plastic, broken seals and spilt liquids.
  - Most chemicals are perishable. Maintain an alert system to warn of pre-expired chemicals.
  - The disposal of chemicals is extremely sensitive. Always refer to local laws and regulations.
  - Fuel and chlorine are the most commonly stored chemicals in humanitarian contexts – make sure they are managed accordingly.
- 

Adapted from the [British Red Cross Warehousing Guidelines](#), [WFP Food Storekeepers Guideline](#), and the [DELIVER Drug Storage Manual](#).

## Temperature Controlled Items

The need for temperature-controlled storage has been increasing in the humanitarian operations over the past few decades, and agencies are becoming more aware of the challenges surrounding temperature sensitive cargo. Temperature control ranges are generally defined in the following ranges:

Temperature Range	Common Name
Surrounding naturally occurring temperature "Ambient Temperature"	
Above +40°	"Excessive Heat"
+30° to +40°C	"Warm"
+15°C to +25°C	"Controlled ambient" or "Temperature-Controlled"
+8°C to +15°C	"Cool"
+2°C to +8°C	"Cold" or "Chilled" or "Refrigerated"
-25°C to -15°C	"Deep freeze" or "Frozen"
Different ranges between -80°C to -40°C	"Ultra-low"

---

Field level humanitarian working conditions also frequently preclude any type of temperature-

controlled storage capacity, so the need for temperature-controlled conditions must be factored into operational plans when selecting and establishing storage. Any form of temperature-controlled space will require basic equipment – air-conditioners, refrigerators, freezers – and some form of power, most commonly electricity.

**NFIs** - Fortunately, the vast majority of non-medical related NFI items can be stored in the ambient range, and many durable goods can be stored in high temperature conditions for long periods of time with minimal effect.

**Basic Pharmaceuticals** - The majority of basic pharmaceuticals can be stored for months at a time in the climate-controlled range (15° to 25°C), and can be stored in ambient temperature for relatively short periods of days or weeks. Exposure to temperatures above 25°C won't immediately damage most basic pharmaceuticals, but can experience reduced shelf life and efficacy if exposed to excessive heat for long periods of time. Prolonged exposure to temperatures below 15°C can also damage basic pharmaceuticals, and warehouse managers should be mindful of both ends of the ranges. Some pharmaceuticals require special temperature ranges – these should either be indicated on the packaging and/or communicated prior to the arrival of the cargo at the facility.

A climate-controlled space can be easily achieved with a regular split air conditioner unit with an automatic temperature sensor built in, and basic insulation. As long as the air conditioner can be set to maintain a specific temperature and have access to electricity, the climate-controlled range is achievable. Climate controlled storage spaces are more effective when built into smaller rooms, with proper insulation and limited access to prevent heat loss. Thermometers should be kept in climate-controlled spaces at all times for quick reference, and agencies may wish to invest in remote sensors that don't require the storage area door being opened, or data loggers that continually record temperatures. Where power isn't available 24 hours a day, climate-controlled storage should be built to remain below 25°C for at least 70% of any 24-hour period.

**Cold-Chain** - Cold-chain storage includes anything in the "frozen," "refrigerated," or "cool" categories. Cold-chain management requires equipment specifically planned and used for the required temperature ranges. This might include keep cool boxes, specially calibrated refrigerators, and refrigerated trucks/containers. Cold-chain also requires special monitoring and training. For more information on cold chain management, please refer to the [cold-chain section of this guide](#).

## Dangerous Items

Warehouses are frequently a holding and consolidation point for extremely dangerous items, and humanitarian storage facilities are no exception. Humanitarian agencies may be handling and storing highly volatile or reactive compounds without understanding them. Field level warehouses may not have the proper storage set up for dangerous items, and workers may not be fully educated on the proper handling of dangerous items.

**Reactive Substances** - A reactive substance is any substance that interacts with other nearby objects, altering one or both in noticeable and possibly dangerous ways. In the context of warehousing, two seemingly inert or relatively stable compounds may be safe when stored by themselves, but when stored next to each other or in a facility may cause adverse or violent reactions.

Reactive substances can cause quick and noticeable reactions, or slow and hard to immediately recognise reactions. Both can be damaging to inventory, physical structures and pose hazards

to humans. A notable example of a substance frequently used by humanitarian agencies is HTH Calcium Hypochlorite (Granulated Chlorine) used in health responses.

- HTH emits fumes, even in its solid form, that corrode metal. HTH stored in an enclosed space can degrade other NFIs near by (metal shovels, medical consumables), and even degrade metal racks and warehouse structures.
- HTH combined with water - forming liquid chlorine - can cause a flammable reaction when combined with liquid fuels such as gasoline or diesel.

Other notable reactive compounds used by humanitarian agencies might include lead acid batteries, cleaning agents, and synthetic fertilisers.

Reactive substances should be properly labelled on their exterior packaging, and warehouse workers should be aware of the nature of the reactive substance while handling them. Reactive substances must be stored in well ventilated spaces inside storage facilities. Any known reactive substance should be well inspected to ensure packing isn't compromised, and there is no evidence of leakage. Warehouse managers should work with program staff to ensure reactive substances are stored for as short a time as possible, minimising hazards to the warehouse workers.

**Fuel** – Storage and management of fuel can be extremely hazardous. Liquid or compressed gas fuels by their nature are highly combustible and should be treated separately than other storage items.

Fuel should be stored in a separate storage area outside the main facility, and at least 10 meters (preferably more) away from the main structure. Any fuel storage area should be well ventilated, and be accessible only by designated persons. Fuel storage areas should have the appropriate fire suppression equipment nearby, and staff should be instructed not to smoke or perform external work in the immediate vicinity of the storage area. **Never** store fuel in a completely enclosed storage facility such as a shipping container, or a facility that can reach excessive heats. For more fuel guidelines, please see the [Fuel Management section of this guide](#).

**Sharp or other dangerous items** – Some objects may be inert, but still dangerous, such as syringes, nails or farm equipment. Wherever possible, cartons/overpacking containing sharp objects should be well marked, and if necessary cartons should be double packed. Cartons/packaging containing sharp or dangerous items should be inspected for holes or damage. Warehouse workers should use gloves and other protective gear as needed when handling sharp objects.

Other dangerous goods common to humanitarian operations might include compressed gas cylinders. Even if a compressed gas cylinder is storing non-flammable compounds, contents under pressure can cause violent eruptions that can harm or kill handlers. Compressed gas cylinders should never be stored in excessive heat, and should be laid on the ground or securely fastened to a wall. If possible, avoid storing compressed gas altogether, or for as short as possible.

For more information on proper warehousing and storage of dangerous goods, please reference the [dangerous goods section of this guide](#). Take extra [note of the table of dangerous goods that should not be stored](#) in the same warehouse, or next to each other in the same warehouse.

## Regulated Items

Some items may not be dangerous to handle, but are considered “regulated,” either due to their value or for legal reasons. Some governments may deem some medications, communications equipment, or other special items as regulated items, resulting in a requirement for special handling. Controlled storage spaces might also be used for bonded or pre-cleared cargo.

Regulated items should be safely separated from the rest of the storage facility. Regulated storage space should be access controlled, with only appropriate personnel having keys or authority to enter. Depending on the specific regulation, regulated items may require special labelling, and more frequent inspection, and may even require inspection from outside companies or government offices.

## **Mechanical Equipment**

The proper storage of mechanical equipment can be frequently overlooked in storage settings. Mechanical equipment, including generators, vehicles and pumping equipment, will still require routine inspection and maintenance. Equipment with engines will still have plastic and rubber components - including sealants, filters, valves and tubing - which will degrade over time and render the equipment useless. Equipment with liquids - such as motor oils, gear lubricants, or fuel - can evaporate, harden or even slowly corrode machine parts. Large external rubber surfaces - such as tires, water bladders or inflatable boats - are especially prone to damage in long term storage or excessive heat.

If organisations choose to keep equipment in storage, there are several steps to keep equipment running well:

- Vehicles should be “exercised” once every month - meaning the engines turned on and if possible driven a short distance. If possible, generators should be turned on and run for a few minutes to cycle fluids inside.
- Large rubber surfaces, such as boats or water bladders, should be unfurled and inspected every six months to inspect for breakage or damage to seams.
- Once a year, a mechanic or technician should be brought in to do an inspection of all the equipment. All tubing and filters should be repaired or replaced if necessary.

The longer equipment is stored for, the more likely it is to not be usable when the time comes. This is especially problematic in pre-positioning facilities, but should be observed in field warehouses as well. Where required, storage of special mechanical equipment should be kept for as short a time as possible.

## **Warehousing Tools and Resources**

### **Templates and Tools**

[TEMPLATE - Binder Labels](#)

[TEMPLATE - Box Label](#)

[TEMPLATE - Donation-Loan Acknowledgment Letter](#)

[TEMPLATE - Equipment Maintenance Log](#)

[TEMPLATE - Goods Received](#)

[TEMPLATE - Loss Report](#)

[TEMPLATE - Material Loan Certificate](#)

[TEMPLATE - Physical Inventory Form](#)

[TEMPLATE - Release Order](#)

[TEMPLATE - Stock Card](#)

[TEMPLATE - Stock ID Label](#)

[TEMPLATE - Stock Report](#)

[TEMPLATE - Temperature And Humidity Monitoring Card](#)

[TEMPLATE - Temporary Allocation](#)

[TEMPLATE - Warehouse Equipment Maintenance Schedule](#)

[TEMPLATE - Warehouse Inspection Checklist](#)

[Guide - Pallet Specifications](#)

## Inventory Planning and Management

Inventory management refers to the knowledge and practices of keeping the optimal amount of any amount of material in a given storage facility. When maintaining a storage facility, inventory management becomes an integral part of supply chain management. It is complementary to warehouse facility management and the physical management of stored material.

Correct inventory management helps ensure the timely delivery of supplies. Proper inventory management requires deep knowledge of both the acquisition process and consumption patterns, and is achieved broadly through three key activities:

- Accurate forecasting of demand.
- Close monitoring of stock levels and consumption.
- Timely ordering of the right amounts of goods.

In addition, the lack of inventory management can lead to increased holding costs, wasted stock or holding too much stock with the respective cost burden and risk increase.

## Common Terms in Inventory Management

**Bin Card** Document updated by the store keeper that tracks the inventory kept of a single product in a particular bin.

---

**Buffer Stock** Amount of stock equivalent to the consumption during the standard replenishment period.

---

---

**Committed Inventory** Particular items in the inventory which that committed to a particular order or transfer in the near future.

---

**Demand Signal** Any form of request to remove stock from a warehouse or storage facility coming in any format.

---

**Inventory** Any stored material, including both raw materials and finished goods. Also commonly referred as stock, though in the manufacturing sector, "stock" only comprises the finished products that are kept in the store.

---

**Inventory Ledger** Accounting document or computer record that tracks inventory transactions (receptions and dispatches) in terms of quantity and value.

---

**Lead Time** The time lapse between the moment when the order is placed and the moment of its reception.

---

**Minimum Stock** The minimum quantity always available in stock to avoid shortage. This is important for products that are critical or difficult to re-supply, and where shortages can jeopardize a project plan. Minimum Stock = Buffer Stock + Safety Stock.

---

**On Hand Inventory** Items in the stock that are available to be released.

---

**Over-Stock** Situation in which too much inventory is kept in the store.

---

**Physical Inventory** The process of physically counting and verifying goods in stock in order to reconcile data on record with reality.

---



---

<b>Re-Ordering Cycle</b>	Period of time between two successive regular orders for a particular item in stock.
--------------------------	--

---

<b>Safety Stock</b>	Level of extra stock that is kept to mitigate risk of stock-out caused by uncertainties in supply and demand.
---------------------	---

---

<b>Stock Card</b>	Document updated by the store keeper that tracks the inventory kept of a single product in the storage facility.
-------------------	--

---

<b>Stock Keeping Unit (SKU)</b>	A unique code or nomenclature that designates a single line item of a larger consignment. SKUs may be tied to a specific production run or expiration date, and may denote only a product of specific characteristics.
---------------------------------	--

---

<b>Stock-Out</b>	Situation in which inventory levels cannot cope with the demand for a certain item and stock is fully depleted.
------------------	---

---

<b>Vendor Managed Inventory (VMI)</b>	Inventory management strategy in which suppliers manage physical inventory as part of their retailer's inventory.
---------------------------------------	---

---

## Supply Chain Strategies

Inventory management is essential when relief supplies are transiting through a storage facility. There are several reasons why inventory management is key in the supply chain. The primary reason is to help deliver supplies in a timely manner. Managing the stock contributes to **copied with the uncertainty** acting as a buffer between demand and supply. This includes adjusting for **lead times** in the supply chain, which is particularly pertinent in international procurement. In addition, a well managed inventory can contribute to **economies of scale**: buying large quantities can reduce the cost per item, though ongoing storage costs must also be considered.

When keeping an inventory for relief operations, it is highly recommended to develop a "stock policy" aligned with the organisational supply chain strategy. Stock policies guide organisations on the decision process of keeping any type of stock in any location. Applying certain logic to

stock management is the first concern for critical items in the relief operations and applicable to all types of storage facilities.

Stock policy is broadly defined by the following questions:

- Where should the inventory be located?
- What specific products should be available at each location, and in which quantities?
- When should inventory at a particular location be replenished?
- How much should be ordered to replace it?

The answers to these questions are dependent on two interrelated issues: the supply chain strategy and the type of stock.

## **Main Strategies**

For the purpose of this guide, "supply chain strategy" refers to the logic behind the decision of moving goods through the supply chain. There are two main applicable strategies:

### **Push Strategy**

In a "push strategy," need is anticipated before a real demand exists and supplies are "pushed" into the supply chain. The most typical examples of "push strategy" in relief operations are common in: contingency supplies as part of an emergency preparedness plan, the opening of a new program, or in the supply of seasonal items like winter kits or mosquito nets.

Typically push systems operate when the demand is unknown in quantity or time. Quantities are usually based on estimations and driven by assumption on the situation that can generate the demand.

### **Pull Strategy**

In a "pull strategy," the need is formally expressed by a consumer and the supplies are "pulled" into the supply chain. In relief operations the "pull strategy" is typically used during short term projects, construction or rehabilitation works or when supplying expensive equipment such as vehicles or telecoms material.

The pull system operates when the demand is known in time and quantity - quantities are clearly defined and the regular supply chain activities trigger demand signals triggered from the final end of the supply chain. Generally, the pull supply chain strategy allows agencies to manage small or individual units of inventory accurately.

## **Type of Stock Holding**

The initial logic of a stock holding will also determine the inventory management system in place. The most common types of stock holding in relief operations are:

<b>Buffer</b>	Buffer stock is stock that acts as a buffer between supply and demand. It is impossible to plan perfect quantities, and buffer stocks help even out unanticipated demand. Most of the decisions in buffer stock are taken based on how much of these items should be kept in the organisation's warehouse.
<b>Kitting</b>	Consolidated supplies of different nature for further assembling is known as kitting. In kitting, supplies are dependent on each other for delivery. Imbalances of stock levels may lead to inefficiency as parallel inbound streams must be coordinated within the inventory. In addition, two different stocks need to be managed: one for the original supplies and one for the assembled kits.
<b>Splitting</b>	Splitting is when stock is split from large consignments in smaller lots to be delivered to different locations or consumers, sometimes at different moments. Splitting is mostly used to gain procurement efficiency and economies of scale. Planners only need to manage a single inbound stream, but respond to demand signals from multiple consumers with uneven demands. Consolidating these demands to calculate the amount to be ordered can be challenging, and larger buffer stocks may be required.
<b>Contingency</b>	Contingency stock is kept as part of a contingency plan. There is little inventory management as contingency stock suffers minimal rotation. Nevertheless, if perishables are part of the contingency stock, they may be included in a rotational stock system.
<b>Vendor Managed</b>	Vendor Managed Inventory (VMI) or virtual stock is kept in the vendor facilities until a release order is activated. The vendor reserves specific amount of supplies as part of its own inventory or grants certain manufacturing capacity with a specified delivery time. Although this type of stock can be used for many purposes, it is commonly used as part of certain contingency plans.

## Other Stock Policy Considerations

In addition to the supply chain strategy and the type of stock holding, some extra considerations can be taken when defining a stock policy:

### Financial Origin of The Product

The products in stock may have several financial origins:

- Procurement using donor funding.
- Procurement using organisational internal funds.
- In-kind donation from an International organisation, private sector, or NGO.
- Remaining materials from a particular project transferred to one or several on-going projects.

Depending on its origin, some management restrictions could be applicable: if products in stock are acquired with specific funding or for a specific purpose, the inventory levels must be

managed accordingly. In some cases, these items can be considered committed inventory.

## Nature of the Stored Goods

The type and nature of stock can also influence how inventory is managed. Particular considerations should be taken with perishables, consumables, or products that are essential to the program implementation such as drugs in a health program, food in a nutritional program, or fuel.

## Dependency Between Stock Items

Storing products with dependent demand means that products in the stock are directly related to other stock items, including:

- **Kitting** - The consumption of one stock item entails the consumption of both.
- **Support Equipment** - Spare parts for machinery; the use of the generator requires the use of its replacement parts.

The demand for both products can either move in tandem (i.e., products belonging to a Non-food items kit) or in the opposite direction. Demand for a given product can be estimated based on the consumption of another supply.

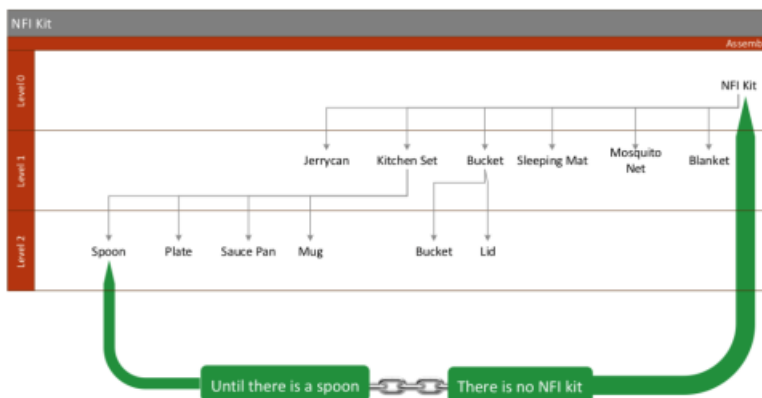

## Stock Value

Stock can be categorised according to its financial value, while stock management can be influenced by relative stock values. Understanding stock value can help to manage risks, plan expenditures on new and replacement stocks, or to prioritise resources on the areas of greatest value. However, low-cost items can be crucial to some relief operations and should not be neglected.

## Level of Accounting

In the field of inventory management, a Stock Keeping Unit (SKU) refers to a specific product type stored in a specific location. The term SKU also refers to a code made of letters and numbers that identifies a product in the store. A SKU is not unique to each item (like bar-codes are), but the number used to identify each product type in the store. It designates a single item of a larger consignment. SKUs may be tied to a specific production run or expiration date and may denote only a product of specific characteristics.

The SKU is intended to be the most dis-aggregated level of dealing with inventory. An inventory with multiple SKUs will require very different handling procedures than an inventory with few SKUs.

For example, when storing buckets a decision must be taken regarding the pertinent characteristics that will define it as a SKU. Is it appropriate to account for all buckets under the same SKU? Or is it pertinent to differentiate buckets by specific characteristics like: colour, size and material, thus creating three different SKUs? The correct SKU design will depend on the type of program and the product's intended use. If buckets are only used as part of an NFI kit, the colour of the bucket may not be important. If buckets are used to segregate waste in health care facilities, the colour of the bucket may be very important. Possible attributes for designation of a SKU:

- Type
- Colour
- Weight
- Volume
- Dimensions
- Packaging
- Technical information
- Anything else

While SKUs are designed to keep track of inventory to the level of a specific product, they can also help to reconcile stock levels, to analyse which products are more demanded, or to identify reorder point for products.

## Managing Inventory Levels

Keeping inventory levels optimal at all times is achieved when demand is fulfilled on time while resources such as time, space, effort, and expenditures are efficiently managed. Deciding what is the appropriate inventory level requires a good knowledge of demand patterns (forecast) and supply capacity (scheduling) - both are necessary to decide when to order and the period to be covered.



(Adapted from Ptak, Smith, 2016)

## The Order Cycle

Movements of goods within a storage facility can be summarised in "INs" (when goods are received) and "OUTs" (when goods are delivered). The balance between inbound and outbound movements in the warehouse determines the inventory level. The quantity of stock delivered during a certain period of time is defined as consumption, normally measured in items/time.

The period of time between two successive regular orders for a particular item in stock is called "*re-ordering cycle*."

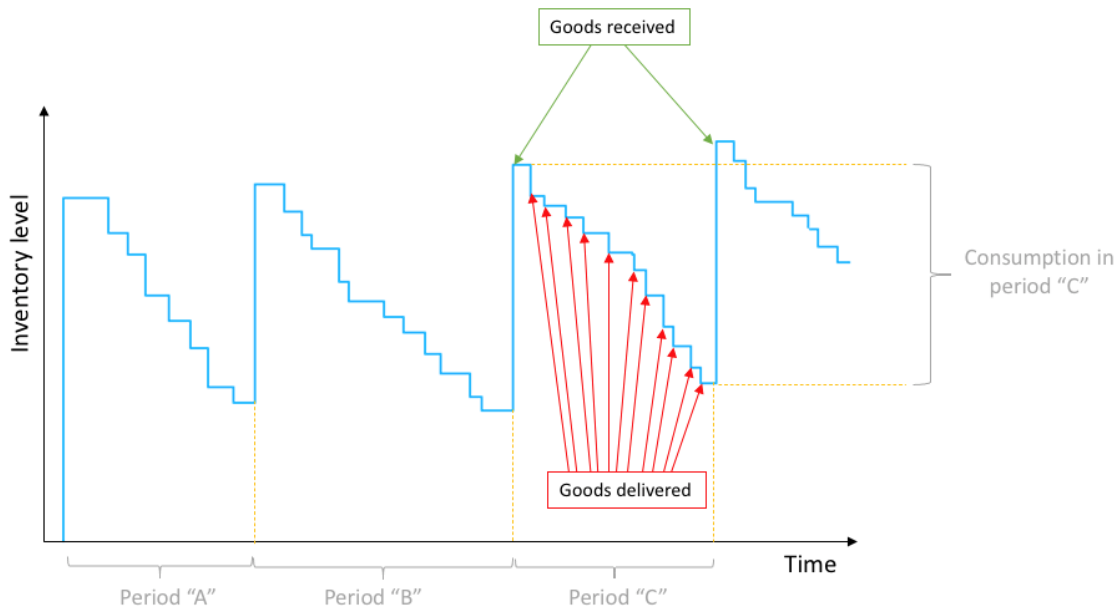

Goods are not automatically restored in the warehouse - a re-ordering process must take place. Agencies must place an order of a certain quantity and wait for its reception. The time lapse between the moment when the order is placed and the moment of its reception is known as "*lead time*". The amount of stock consumed during a standard lead time is known as "*buffer stock*".

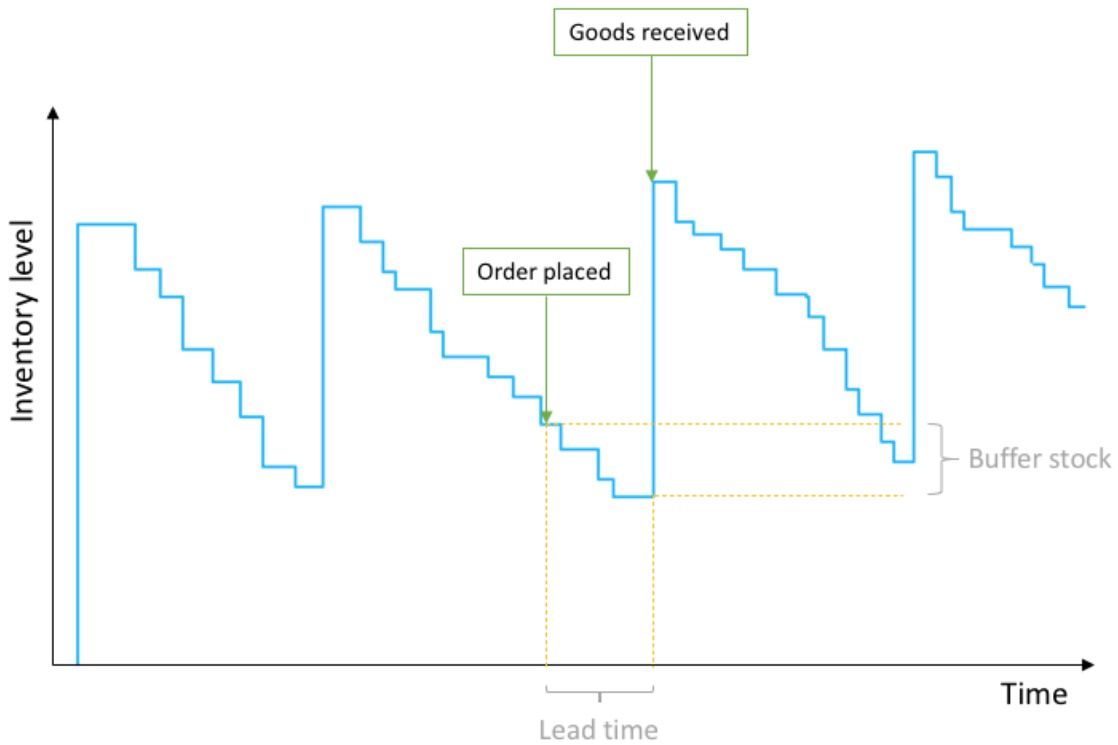

The lead time for the critical items in the storage facility must be well known. The balance between consumption and lead time will allow defining the optimal buffer stock.

Buffer stock = Lead Time for replenishment (in days) × daily consumption of the item

Despite keeping a buffer stock, "stock-outs" may occur. Stock-outs are defined as stock of one or more items being fully depleted. Stock-outs occur when anticipated orders are long-overdue, when actual lead times are longer than expected lead times, or when consumption is significantly increased. To prevent stock-outs from occurring, a safety stock should be maintained. "Safety Stock" is a quantity of extra stock that is kept to mitigate risk of stock-outs caused by uncertainties in supply and demand. Common examples uncertainties in relief operations might include access constraints, harsh climate events, or increased needs due to changing social conditions. Awareness changing situations and the associated potential supply chain bottlenecks can help planners design a safety stock appropriate to the operational context.

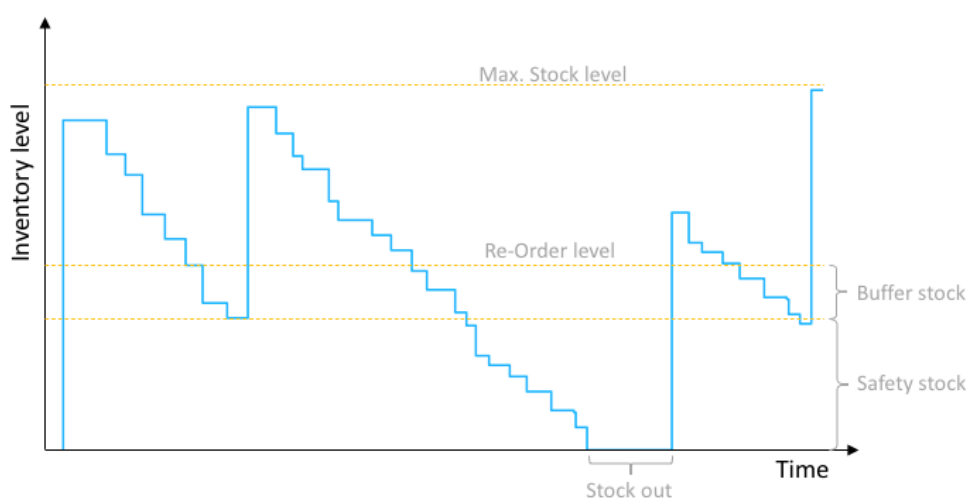

Once buffer stock and safety stock levels are defined, a "reorder level" should be established. Reorder level (or Re-Order Point - ROP) is the minimum stock level of any given item before another order is placed. Reorder levels must be sufficiently high to allow regular replenishment of stock before reaching a critical situation and a potential stock out. The reorder level is calculated by adding the safety stock to the buffer stock.

Re-Order Level = Buffer stock + Safety stock

When defining reorder levels, agencies should consider that storage facilities have a limited capacity. Planners should define the maximum space available for each of the stored items and establish a maximum stock level for each item. This is especially critical when storing items requiring specific storage conditions, such as temperature sensitive goods or dangerous materials, for which allocating extra space may not be immediately available. To allow a certain degree of manoeuvrability, the "maximum stock" level should not be reached.

## Inventory Components

Correct inventory management requires a broader vision than just inbound and outbound

movements. Understanding different ways to visually manage inventory is important in supply chains with long transport periods, limited storage capacity, or high rotation of items or where different orders overlap in time.

From the moment an item is ordered until the moment the item is received and dispatched, the item passes through different states:

- **On hand/Running Inventory** - The current stock in the storage facility. It is the number of available units of a certain SKU for running operations.
- **In transit Inventory** - The stock being transported between two locations. Although not in a warehouse, supplies in transit remain property of the organisation and should be recorded/accounted. It is common for senders to deduct an item from inventory controls before the receiver accepts it. In transit tracking is particularly important when transit between facilities or to a delivery location may take long periods.
- **Committed inventory** - Stock that is committed to a particular order or transfer. While "on hand" inventory is the number of available units, "committed" inventory are items which are physically in the warehouse but are not technically available.
- **Ordered Inventory** - Stock that has been ordered to replenish the inventory but is not yet received. If an order is partially received, the remaining quantity is called back-order. If inventory back-orders are a frequent occurrence, it may be necessary to evaluate the inventory control procedures.

## Demand Forecasting

"Demand forecasting" is the process of attempting to predict future demand as accurately as possible using available data. Demand forecasting can be a simple task, but it becomes more complex when managing many different products and/or when multiple customers with differing demand cycles place orders concurrently.

A good forecast can be achieved by reviewing historical orders and consumption patterns. Consumption data is normally arranged in discrete time slots. Different time slots can be used depending on the frequency of outbound movements from the inventory: years, quarters, months, weeks, days. Though the time period granularity has to be defined according the context, "monthly consumption" is the most commonly used. A monthly consumption is the quantity of a particular item leaving the warehouse per month.

Recording and monitoring consumption figures is the key activity to forecast. The simplest way to calculate monthly consumption is by counting the deliveries recorded on stock cards or other tracking systems. The more records are available on historical consumption, the more accurate and reliable the forecast will be. Between three and ten previous "time slot" previous periods can provide reasonable results for demand forecasting.



STOCK CARD					
<i>Ampicillin - Capsule 250 mg (Totapen<sup>®</sup>)</i>					
N Rack:		Min stock:	100.000	Max stock:	
Date	Origin or Destination	Incoming	Outgoing	Stock	Remarks
4/1/20	UNICEF	130.000		130.000	
5/1/20	Béboro		30.000	100.000	
5/1/20	Koumra		5.000	95.000	
6/1/20	Motsala		25.000	70.000	
30/1/20	Inventory			70.000	
1/2/20	UNICEF				Ordered 150.000
2/2/20	Béboro		20.000	50.000	
5/2/20	Goundi		35.000	15.000	
4/3/20	UNICEF	150.000		165.000	
7/3/20	Béboro		20.000	145.000	
9/3/20	Motsala		10.000	135.000	
12/3/20	Goundi		15.000	120.000	
12/3/20	Koumra		8.000	112.000	

Monthly consumptions

January: 60.000

February: 55.000

March: 53.000

Average monthly consumption: 56.000

Demand (D) can be established based on the average consumption of previous records. Average consumption is calculated by adding a number of consumption (C1- CN) figures and dividing by the number (N) of figures used:

$$D = C1 + C2 + C3 + \dots + CNN$$

Consumption can be calculated by reviewing historical periods of time in relation to key destinations or areas of intervention. In relief operations, consumption during the kick-off of an activity may be higher than in subsequent orders. This is commonly due to:

- Push style inventory system.
- Lack of coherent demand signals.
- Planners sending supplies based on worst case scenarios.

Stock managers should not consider forecast figures as a certainty. For critical items it is recommended to define alternative scenarios which reflect different possible future developments. The typical exercise to deal with uncertainty consists of designing a best and a worst-case scenario in addition to an average case forecast.

To define demand in worst and best-case scenarios, planners should identify the maximum positive (and negative) variation (Vmax) over the last recorded time period, and add (or deduct) the Vmax to of the average monthly consumption.

Month	Consumption (Kg)	Variation
January	300	0%
February	320	6% $V_{max}$
March	285	-5%
April	302	0%
May	297	-1%

Average = 301  
Demand =  $301 + (301 \times 6\%) = 330 \text{ Kg}$

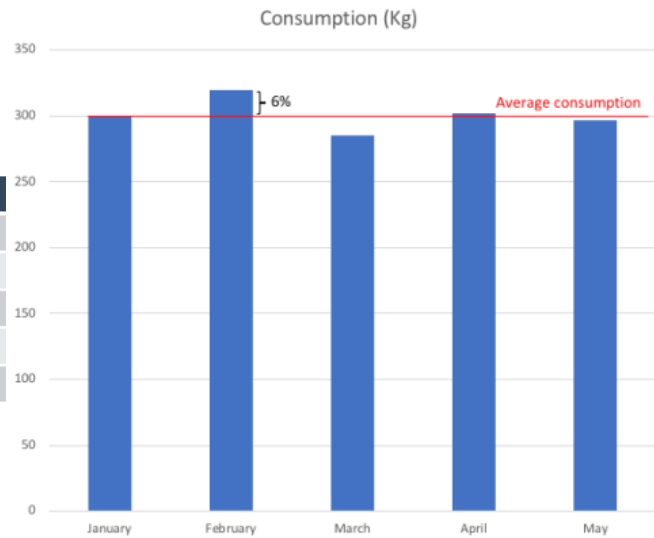

Depending on the context and the type of inventory, seasonal fluctuations may appear. Data based on previous years or consumption figures, or of previous interventions can help to prevent stock-outs or over-stocks due to seasonally increased or decreased demand. It is recommended to check previous annual demand signals to identify and understand seasonal patterns.

Using annual data to calculate average monthly consumption can help balance sporadic high demands: surplus stock built up during low consumption periods should compensate higher demand during high consumption periods. If agencies plan to hold unused stock for anticipated higher demand, they must ensure that stock will not expire or become unusable by the higher period of anticipated demand. Pre-positioned or new stock items may not be a major issue, but inventory delivered to a country may already be approaching the end of its life and must be used accordingly.

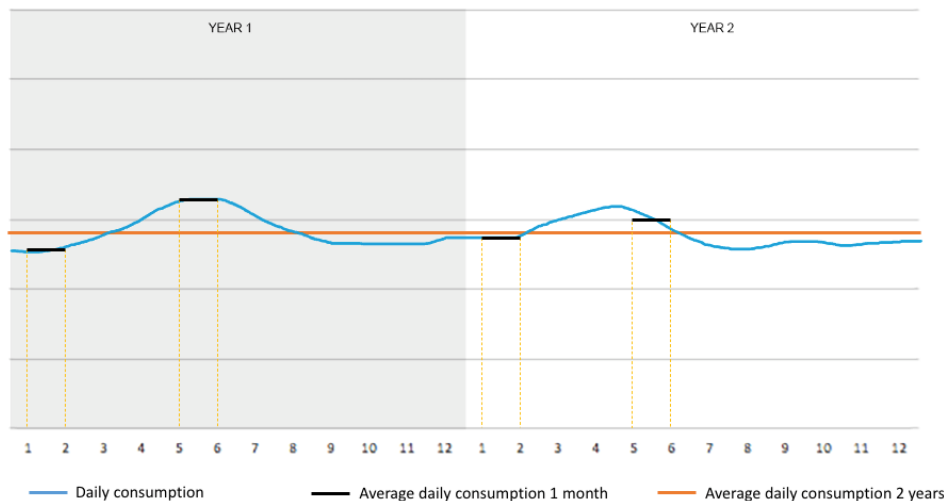

If seasonal fluctuations are substantial and average consumption between different months differ significantly, seasonal stocks with specific thresholds could be considered. In such cases demand forecasts must accommodate the time-frame and the period in the year to be covered.

## Limitations of Forecasting

While forecasts can be useful for smoothing out demand curves and predicting seasonal needs, they also come with their own limitations, especially in the humanitarian context. An inappropriate demand forecast can lead to stock wastage in the form of unused items piling up, or major stock outs.

A demand forecast should never be confused with the goals of a project. Humanitarian projects often run on expected population numbers or goals reported to donors. A demand forecast should be built upon real consumption data and informed by demand signals, not the desired distribution numbers. Early in a humanitarian intervention, it can be hard or impossible to know what real consumption numbers will be, and project plans or available funds is the only data to work from. After a project has been running for a few months, any given forecast must be revisited.

Another risk of demand forecasts in humanitarian response is the unpredictable nature of the response environment. Unforeseen natural disasters, civil unrest or governmental regulations can dramatically alter demand signals, driving up or slowing down consumption. While these events may be hard to predict, they should be adapted into future demand forecasts.

## Defining When to Order

Based on demand data, a replenishment plan for inventory must be designed. A replenishment plan consists of deciding when to order and the quantities to order in the period to be covered.

The decision of when stock should be replenished and when an order should be placed is crucial for successful inventory management. Two different methods can be applied:

1. Based on the pre-established frequency of systematic orders.
2. Based on a pre-established threshold of stock levels, the re-order level.

A third method includes reacting to dynamics external to the storage facility, such as budgetary cycles or combining orders with other agencies as part of a network or consortia. If inventory management is runs the risk of being exposed to external dynamics, coordination

with relevant stakeholders is key.

Agencies should decide if a single method should be applied, or if switching from one method to the other is more useful. This decision depends on criteria such as:

- The phase in the relief intervention: Is the supply chain responding to a stable long-term program? Or is it responding to the early phases of a response with high levels of uncertainty?
- The standard delivery time of the orders: Are the supplies sourced from the local market taking short lead times to get the ordered items? Or the supplies are sourced in international market with long lead times?
- The supply chain strategy: is the supply chain operating under a push or pull strategy?
- The number of different products ordered simultaneously: Although forecasting may be done on the level of SKU, it is a common practice to order on the level of a product group or supplier. Product grouping can be designed according to the market and supplier (i.e., construction materials, drugs, hygiene) or demand dependency (i.e., kits).

## **Systematic Orders**

Systematic orders based on a pre-established frequency is a common practice in:

- Long term programs with steady consumption rates.
- When operating under a push strategy.
- When supplies are sourced in the international market and undertake long transportation periods.
- When different products are grouped and ordered simultaneously.

Systematic ordering is the most efficient method to refill inventory as it establishes working patterns and distributes the workload regularly throughout time. Systematic ordering also requires good planning, team discipline and reasonable forecasts.

The re-ordering cycle is directly related to the demand (D) and the quantity to be ordered (Q): the larger is the quantity ordered, the longer will be the period between orders. The higher the demand (D), the shorter will be re-ordering cycle.

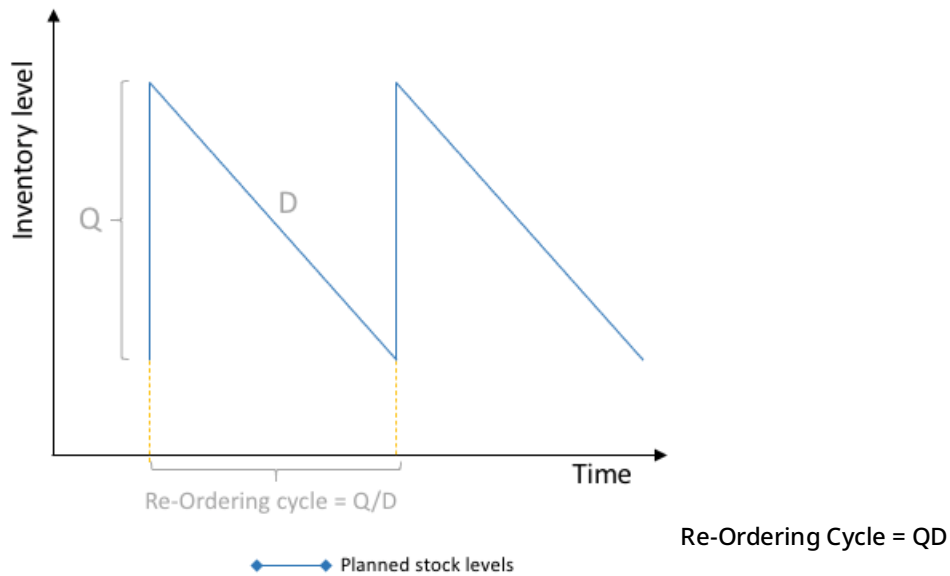

The frequency of orders may also be affected by other factors such as:

- Lead time.
- Costs of reordering (CR), including costs of labour in the procurement department and the cost of transporting.
- Costs of holding inventory (CH).
- Available storage capacity.
- Security risks of the given context (related to transport or to storage).

All the above-mentioned factors must be considered to find the best compromise between inventory levels and the frequency of orders. For international orders having a lead time between 3 to 4 months, bi-annual or annual orders are considered a correct compromise. For domestically procured or locally available items, shorter lead times may be acceptable.

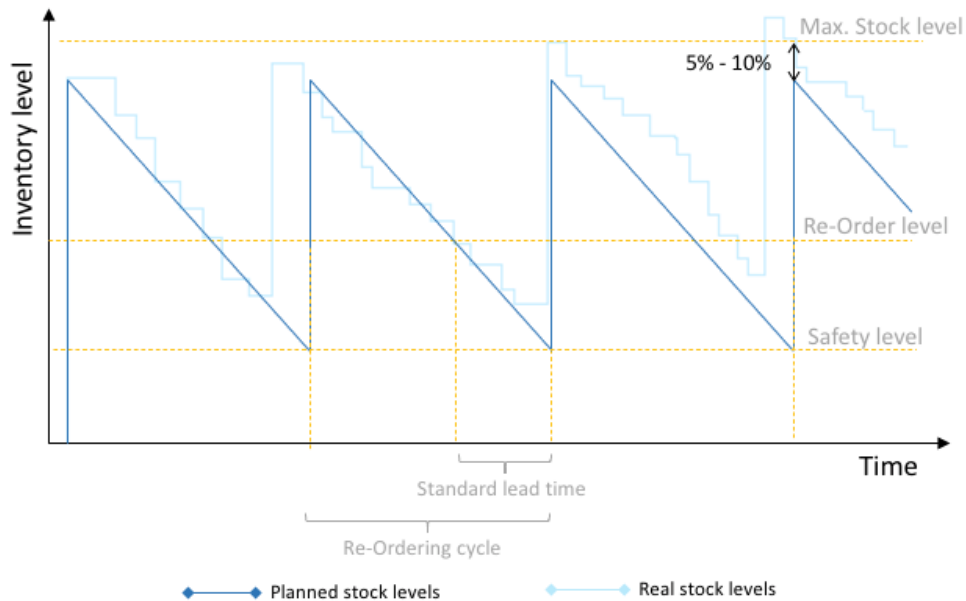

In general, a 5% to 10% buffer can be kept as a margin from the maximum stock level to avoid over-stocks after periods of lower consumption. In cases where the re-ordering cycle is constrained because of limited storage capacity, consider alternative storage facilities to decrease the stress in the supply chain.

There are several mathematical models in commercial logistics to calculate the optimal re-ordering cycle. One of these models is based on the demand and the economic variables only (costs of reordering an item and the cost of holding it in the inventory). It is referred as the Economic Order Quantity (EOQ) model:

$$\text{Optimal Re-Ordering Cycle} = 2D \times CRCH$$

Nevertheless, estimating the costs of reordering and holding an item in inventory can lead to complex calculation processes and is only recommended for well-established and mature supply chains.

Misalignment between expected inventory levels and real inventory levels for certain items may happen due to fluctuations in demand or variations in lead time. Corrections to the pre-established frequency of orders can be done after certain re-ordering cycles have been completed. It is recommended to stick to clear and easy-to-remember frequencies: monthly orders, quarterly orders, bi-annual orders or annual orders. This will ease the coordination between the different stakeholders all along the supply chain.

### **Pre-established Thresholds/Minimum Re-order Levels**

A second method used to decide when to place an order for stock replenishment, consists of monitoring stock levels and placing orders whenever they reach the pre-established re-order level. This method is normally applied under pull supply chain strategies, at the beginning of new programs when consumption records are unavailable, or when the concerned articles are easily accessible with short lead times.

Special attention must be taken when storing articles with dependent demand or when

requiring kitting for order processing. Stock items with dependencies on items with lower stock levels will determine the need to launch an order for a whole group of items.

## Calculating Order Quantities

Demand (D), the re-ordering cycle (Ro) and the quantity to be ordered (Q) are closely related. The longer the period between orders, the larger the quantity to be ordered. If demand increases, the larger the order that will need to be placed.

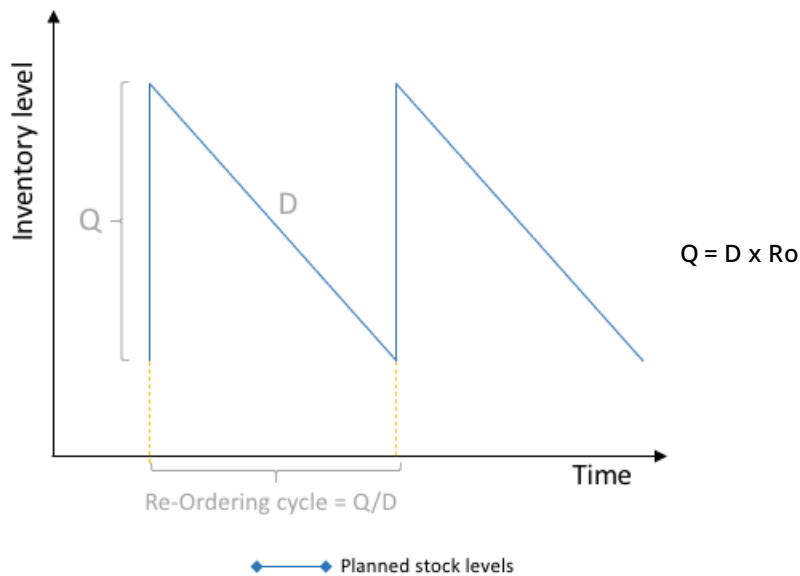

Independently of the re-order level, the quantity to be ordered (Q) can be calculated at any given time based to the following variables:

- Demand (D),
- Lead time (LT)
- Time period to be covered by the order (T)
- Stock level (S): the running stock at the given time
- Items in the pipeline (P): ordered inventory, transit inventory, back orders, loan reimbursements, etc.

The basic calculation for the quantity to be ordered (Q) considers the demand during the period to be covered ( $T \times D$ ), plus the demand during the lead time ( $LT \times D$ ), subtracting the quantities in stock (S) and the quantities in the pipeline (P):

$$Q = (T \times D) + (LT \times D) - S - P$$

If preparing an order when inventory reaches the pre-established re-order level, the quantity to be ordered (Q) will be calculated in the same way but using the re-order level instead of the running stock level.

$$Q = (T \times D) + (LT \times D) - R_o - P$$

In cases where the safety stock (SS) must be replenished (totally or partially) the required amount should be added to the previous formula.

$$Q = SS + (T \times D) + (LT \times D) - S - P$$

More sophisticated models can be applied to calculate the optimal quantity of goods to order. The Economic Order Quantity (EOQ) model can be used for computing the economic optimal quantity of goods while ordering. This model is based in economic variables such as the ordering costs and the holding costs. It defines the optimal quantity as a balance between increased costs due to holding a lot of stock, and the economy of scale obtained when making big orders.

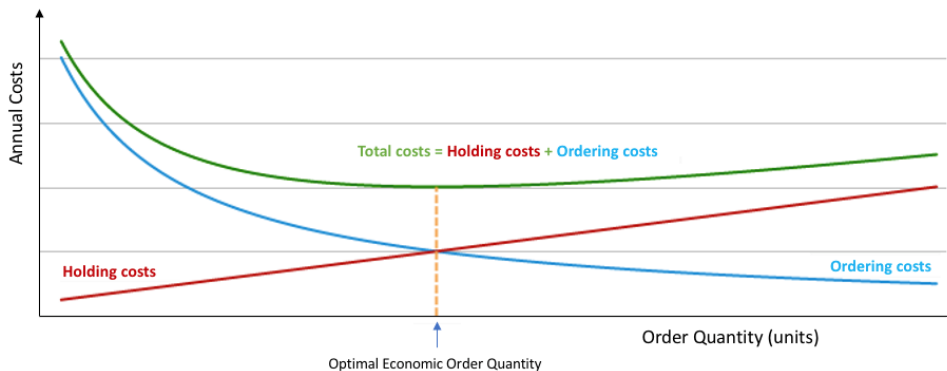

According to the EOQ model, the optimal quantity to be ordered is defined by the annual demand quantity (D), the costs per order (CR) and the holding costs (CH), as follows:

$$\text{Optimal Economic Ordering Quantity} = 2 \times D \times \frac{CR}{CH}$$

## Inventory Control

The basic purpose of inventory control is to know at any given moment what supplies are in a given storage location or warehouse. Inventory control is a cornerstone of good inventory management.

Inventory control ensures traceability and transparency of any storage activity, providing accurate information on any movement of supplies including:

- Where the products come from.
- When the products were received and in which quantities.
- Where the products have gone.
- When the products were dispatched and in which quantities.

Inventory control improves stock management practices and supports decision making through:



- Optimising working processes and costs.
- Providing some degree of protection against potential over-stocks or stock-outs.
- Anticipating products getting expired or close to expire.
- Detecting losses or any deterioration of the stored products.

Inventory control is essential for accountability, providing values of stored items and consumption status from projects close to conclusion. Proper inventory control will provide value to the storage facilities through optimised management, higher levels of satisfaction among customers and stakeholders.

For a successful inventory control three critical activities must be accomplished:

1. Systematic recording and keeping support documentation accessible.
2. Monitoring consumption, stock levels and inventory performance.
3. Reporting.

## Coordination

Inventory management is central for timely implementation of humanitarian relief operations. For a successful and valuable stock keeping, inventory activities must be synchronised with other activities from stakeholders external to the storage facility: suppliers, transporters, clients, other departments, and others. Key information must be regularly gathered and delivered *from* and *to* relevant stakeholders.

Inventory management should support the ordering process, providing information on stocks levels, expiry dates, consumption rates, etc. Monitoring past consumption can help to estimate future needs.

Transit inventories should also be closely followed. This can be done by gathering information from suppliers or supply chain managers on the current status of local, national and international orders. Tracking in transit inventory will allow planners to properly prepare a given storage facility for shipment reception or to alert clients on the imminent delivery of a pending request or a back-order.

Whenever possible, coordination should also help to anticipate intensive use of the inventory, such as during emergency responses or distribution periods. In such situations, extra resources such as increased labour or extended working hours can be made available.

Potential spikes or steady increases or reductions of demand should also be prevented through coordination. Operational information such as new activities, an increase in the number of people in need or access restrictions to deliver in a certain area, are critical in this sense and can help to prevent situations stock-outs or over ordering.

Data from inventory management can also serve to quantitatively monitor the delivery of relief supplies. Increased or decreased demand patterns contrasted with expected consumption can provide information on the humanitarian situation or outline changes in the management of a particular activity.

Coordination should especially be used during the beginning or ending of projects. Particular donor requirements related to stock keeping must be communicated, with special attention to specific reporting mechanisms and disposition regulations.

## Systematic Recording and Support Documentation

There are two main types of records that enable proper inventory control: those tracking stock movements and those tracking stock levels. Both types are connected as each stock movement affects the level of stock in any given location. Records should be formally cross-referenced allowing traceability of each item from reception to dispatch.

The documenting system in place should be as standard as possible while still avoiding unnecessary complications. The system needs to be established at the onset of operations and fully understood by the staff whose job it is to put it into practice. Training of the warehouse personnel is crucial in this sense.

### Recording Stock Levels

The basic purpose of inventory control is to know at any given moment what supplies are in a storage facility. There are different levels of granularity in terms of recording stock levels.

A basic tool for inventory control is the [stock card and bin card](#), both of which record any movement of physical quantities for each SKU and are stored next to the item in the warehouse, while the [inventory ledger](#) tracks inventory transactions in a central location.

Where stocks are held for different donors, it may be convenient to keep separated records for each donor. This will ease accountability and reporting processes, especially at the closure of the project.

### Recording Stock Movement

All movements of stock should be recorded and supported by the corresponding documents certifying receipt or dispatch of supplies. Supplies should change hands only when the corresponding documents have been signed by the next recipient link in the supply chain. All documents involved in the exchange of goods must be duly archived.

All goods received in the storage facility should be accompanied with [awaybill or a delivery note](#) describing the supplies details and the item origin. If a supplier or transporter does not provide a waybill or a delivery note, the storekeeper should fill in a [goods received note](#). A copy of the signed document should be retained by both the recipient and person delivering the goods.

To dispatch a product from storage, a fully authorised stock release order should be provided. Without the stock release order, the storekeeper should not release any product.

All transaction documents should clearly specify the name and exact quantity of the supplies received/released, as well as names of the individuals or agencies issuing and receiving them. The reference number of the transaction should be included on the related stock cards, allowing full traceability of any goods in the stock.

It is key that all stock receipts, issues, transfers, disposals and adjustments are documented and authorised. Do not postpone any of the essential recording tasks; all stock movement records must be updated immediately. Hard copies of stock cards and waybill/delivery notes should be properly archived within the warehouse premises, and be accessible to authorised persons.

## Monitoring and Counting

Consistent records will enable proper monitoring. Basic things to be regularly monitored are:

***Levels of stock with special requirements:***

- Items reaching critical thresholds (like re-order or safety stock levels).
- Items belonging to specific projects.
- Items with expiry dates.

***Consumption patterns, and the length of time that inventory will last:***

- Items with high rotation.
- Items that are core to running relief operations.
- Items with short order cycles.
- Items with a significantly increased demand that could lead to stock-out situations.
- Items with a significantly reduced demand that could lead to over-stock situations.

In addition, the performance of inventory management can also be monitored. To adjust the management processes, consider monitoring the following information:

- **Inventory rotations** - Transactional frequency, volume and value, identifying those items with higher turn-over. The value of individual transactions can be compared to the average inventory value and to the required workload to manage them.
- **Actual time to completion** - The amount of time from issuing instruction to completion of a task. This might include the time for dispatch preparation, including the time lapse between the moment when the stock release order is received and when goods formally dispatched.
- Number of stock-outs in a given period.
- **Stock valuation.**
- **Quantities and values lost.**

When coming to control and monitor particular items, consider that stocks follow the *Pareto principle*, also known as the "80/20 rule", the "law of the vital few", or the "principle of factor sparsity". This principle states that roughly 80% of consequences come from 20% of the causes. When applied to inventory management, 80% of the movements tend to come from 20% of the line of items. Identifying this 20% of "high-rotation" items is vital for an optimal inventory management.

## **Physical Inventory**

To ensure that records are consistent and aligned with the stock physically on hand, it is recommended to regularly reconcile stock records with actual physical counts. This process is referred as "physical inventory". The frequency of physical inventories may be determined by the number of stock movements, by the value or nature of the stored goods, the frequency of visits to third-party managed locations, or by donor requirements for a specific project.

To optimise the efforts of controlling mechanisms of a physical inventory, an A-B-C system can be put in place dividing the inventory into three categories:

- "A items" with very tight control and accurate records.
- "B items" with less tightly controlled and good records.
- "C items" with the simplest controls possible and minimal records.

Regular control can be achieved dividing the inventory in A, B and C groups and counting a rational combination of each category per period of review. This type of counting occurs when some parts of the stock on hand are counted more often than others, usually following a

schedule, is referred as “Cycle Counting”.

Other forms of counting are:

- **General physical inventory:** Typically happens in predefined periods such as on a yearly, semester or quarterly basis and covers the whole inventory in a given storage facility.
- **On demand inventory of specific items:** For specific reports or requests, particularly for items that may require more regular counting.
- **Inventory by sample:** Random spot checks usually performed by request of auditors or program management. Random spot checks are good to carry out during random or infrequent visits.

When conducting physical inventories, stock should remain stationary - no stock movement should be performed for those items under scrutiny. On demand or random spot checks are easier to conduct and may occur as needed; during random spot checks or on demand inspections only movement of the selected stock item should be halted. A full physical stock count will require the entire facility to be closed to stock movement for a pre-defined period of time.

### **Random Spot Checks**

Random spot checks are encouraged throughout any operation, and at any time. They are useful for when counters only have access to storage facilities for limited periods of time, due to security or operational constraints. Spot checks are also a relatively low effort way to continually monitor activities.

To conduct a spot check, counters should pick out 3-7 line items from any random cargo item in the warehouse ledger and conduct a blind count. To facilitate a blind count, locate the items in the warehouse.

- If the items cannot be located, ask the storekeeper or warehouse manager to help locate them.
- The inspector should conduct their own count, and ask the third-party or other team member to do a separate count conducted at the same time.
- At the end of both counts, compare the two numbers and reconcile any discrepancies between the two counts.
- Cross-check between the physical count and the stock count in the warehouse ledger afterwards. If the physical count does not match the numbers on the ledger, counters should make a note of the discrepancy.

Weights and Dimensions (if required)

- Weigh and measure the 3-7 selected items.
- Cross check against the weights and volumes in the warehouse ledger. Discrepancies in weights and dimensions should be recorded and fixed.

### **Full General Physical Inventory**

When general physical inventory happens, the warehouse should be locked down during the entire inventory period. The overall size of the warehouse and quantity of items stored within it will determine the length of time required to complete a full count. A small facility could be completed in a just a few hours, while a large facility might take several days.

If the physical inventory is expected to take more than a few hours, all users of the warehouse should be informed of the delay and closure. If incoming deliveries are expected, they should

be rescheduled in advance.

In order to mitigate the chance of human error and bias, it is recommended that two separate teams count the same set of items without any information exchange between them. A third person should be appointed to oversee or manage the counting teams. If available, employ the “stock tag” system to facilitate counting.

**Inventory Sheet**

**Stock Tags**

PO	Description	Position	Quantity

**Tag: 2024**

Part No. \_\_\_\_\_ Unit \_\_\_\_\_  
 Description \_\_\_\_\_  
 Quantity \_\_\_\_\_

---

**2024**

Part No. \_\_\_\_\_  
 Description \_\_\_\_\_  
 Unit \_\_\_\_\_  
 Quantity \_\_\_\_\_  
 Location \_\_\_\_\_

Counter \_\_\_\_\_  
 Checker \_\_\_\_\_

(Front)

After Count

Date	Issued	Rcvd

(Reverse)

While on-demand or random spot checking may occur as needed, it is strongly advised that a full stock count should be conducted at least once a year, if not more frequently depending on the size of the facility and the overall volume of throughput. The standard accepted best practice for a full stock count is called “double-blind”, and follows the below steps:

**Double  
Blind  
Count  
Procedures**

1. Two teams of two persons each (four persons total) are identified in advance. These two teams will conduct the count sequentially. All four persons should ideally come from different parts of the organisation, and not have direct control over the stock or direct financial incentive to tamper with stock counts.
2. Warehouse activities are completely halted during the time of the stock count. This means that no cargo goes in or out, and stored items are not moved around the facility. Ideally, only counters should be let inside the facility during counting.
3. The two teams should meet in advance to ensure all parties understand the process.
4. The first two-person team starts at one far end of the warehouse/storage facility and begins counting, using a pre-defined common understanding (example: Piece count per shelf, piece count per line item, etc). The first team member counts, while the second team member records on a pre-defined recording system.
5. The second two-person team begins after the first two-person team. The second count can begin after the first count has ended, or even by waiting for only a few minutes.
6. The second team will count using the same agreed upon common understanding. The second two-person team can start from the same location as the first team, or start from the opposite side of the warehouse.
7. Once the full warehouse/stockroom has been counted fully by both parties, both parties compare counts. Any time there are discrepancies between the two counts, both parties must go to that stock location and reconcile the differing counts.
8. Only after both teams have come to a mutual agreement on the stock numbers can the count be considered closed.

## Discrepancies

Once a physical inventory is complete, the counter should record discrepancies for further analysis and follow up.

Types of Discrepancies:

- **Loss** – There are fewer of one or more line item than is recorded in the warehouse ledger, and there are no waybills/release files to explain the difference.
- **Expired/Spoiled/Infested** – Items are considered unusable because they are past their expiration date or infested.
- **Surplus** – There are more line items than are recorded in the warehouse ledger, and there are no waybills/received notes to explain the difference.
- **Damage** – Stored items too damaged to be usable by the requester.
- **Mislabeled** – Stored items have been erroneously listed as a different item or belonging to a different project in the warehouse ledger.
- **Unidentified** – Stored items do not appear to be associated with any known other item or project in the warehouse ledger.
- **Incorrect Dimensions** – Stored items have incorrect volumetric or weight measurements than what is recorded in the warehouse ledger, or no measurements are recorded at all where required.

Many discrepancies result from simple administrative error. Common problems include:

- A warehouse worker or a loader may confuse two similar line items from two projects and store them together as one.
- Cargo is released, but the warehouse manager forgets to update the warehouse ledger.
- Cargo was recently received but not yet recorded on the warehouse ledger.

Only a full physical inventory will tally the total numbers of all items on hand. If counters find loss or mislabeled cargo during random spot checks, additional investigation may be required to understand the full problem.

## Corrective Actions

<b><i>In cases of loss, spoilage or damage:</i></b>	Counters should reinspect items and conduct additional counts if required. If loss or damage persists after additional counts, then a loss report must be filled out, and the warehouse ledger must be updated. The owner of the cargo must be informed of the loss.
<b><i>In cases of mislabelled or unidentified cargo:</i></b>	Counters and warehouse staff should correctly link cargo to anticipated deliveries. Mislabeled cargo should be properly labelled, an updated stock card placed with the items and the warehouse ledger updated. Unidentified cargo should be linked to a project, donor, budget code or category as required, and be properly labelled in the warehouse and updated in the warehouse ledger. If no information on the cargo exists, warehouse staff must investigate where the stored items may have come from.
<b><i>In cases of surplus cargo:</i></b>	Counters and warehouse staff should reconcile cargo movements with stock on hand. If there is no explanation for additional items discovered, warehouse staff must investigate where the stored items may have come from.
<b><i>In cases of mis-measurement:</i></b>	Newly corrected measurements – weights and volumes – should be updated in the warehouse ledger.

## Follow Up

The frequency and number of inaccuracies should be regularly monitored for each warehouse location. Any stock discrepancy should be reported and analysed and corrective actions should be taken to reduce the risk of further inaccuracies. The logistics team should record the results of general inventories in a file specific to that warehouse location. If a warehouse continues to perform below the acceptable standards, corrective action or training may be required.

## Filing and Reporting

Reporting mechanisms aim to consolidate and communicate all monitored data, especially those signs requiring further action.

There are two types of report:

1. Regular reports.
2. Ad-hoc reports.

Regular reports should be produced in useful time intervals, normally: weekly, monthly, quarterly or yearly. Reports contribute to general program management, help with following up a specific inventory items, assist supply chain strategic decisions, and help update forecasting figures and critical stock thresholds.

The intervals for reports can be set based on the turn-over of the articles and/or the location of the storage facility. As an example, reports from health facility storage running a nutritional program with daily patients and deliveries of medication might want to establish reports in weekly intervals.

Regular reports can include information such as:

- **Stock Summary:** A record of the relevant transactions and stock levels. For all or a particular list of relevant items during a pre-set time period, this might include opening and closing stock levels, average consumption, and total receipts and dispatches. The value of the transactions and the value of the balance quantity may be relevant for some inventories. Perishable products must be included in this summary.
- An outline of those items reaching a pre-established stock threshold requiring re-ordering or other action.
- An outline of those items approaching their date of expiry.
- Key performance indicators, based on the information mentioned in the [Monitoring](#) section on the performance of the inventory management.

WEEKLY MONITORING	
WEEK :	

STOCK LOCATION	
DATES	

PRODCET	INITIAL STOCK	RECEIVED	DELIVERED	DAMAGED	EXTRA	BALANCE	PHYSICAL COUNT
CSB (kg)							
Oil (L)							
Mosquito net (u)							
PPN (sachet)							
Soap (u)							
Salt (kg)							
Sugar							
Plastic bag (u)							

	Name	Date	Signature
Stock keeper			
Supervisor			
Control			

	Moderate	Sev. <6kg	Sev. >6kg
PATIENTS IN PROGRAM			
DISCHARGED CURED			
PATIENT OUT NOT CURED			
TOTAL PATIENTS			
+ NEW CASES			

Title

Template - Monthly Stock Report

File



Fig.: Weekly inventory monitoring report from an outreach stock, part of a Nutritional program with daily distribution of food items and non-food items

Regular reports should be shared with relevant stakeholders, especially those making use of regularly stored items. It is a common practice to cross-check information in the inventory reports with the expected and current number of beneficiaries.

In addition to regular reports, storekeepers should inform the pertinent individuals when relevant inventory events occur:

- The stock level of an article reaches the re-order level.
- One or several stock items are lost, damaged or spoiled. In such cases, a loss report should be completed.
- A stock discrepancy is identified.
- A project is reaching to its end.

## Data management

Reliable, up to date and accessible information is key for inventory management. Data management will enable making the correct information available to the correct people in the required moment. Furthermore, data management is a cornerstone for accountability.

Procedures and means should be in place to ensure that records are properly kept for internal and external use. Basic information to be recorded and kept updated is mentioned in the [systematic recording and keeping support documentation](#) section.



## Formats: Physical or Electronic

The means to store and manage stock data can be physical (hard) or electronic (digital). According to the needs, both methods can be combined and used to complement each other. In case of using both systems simultaneously it is highly recommended to keep one as a "master file", and the other as back-up.

Considerations to choose the most appropriate data format may include:

- **Urgency to setup inventory operations:** Physical data record formats can be set immediately, always accompanied by a basic training. Digital formats can take longer time-frames depending on the operational environment and the organisational culture.
- **Existing funds:** The level of investment is considerably higher for the setup of electronic data management means.
- **Digital literacy of staff:** In some particular contexts, staff will be better able to adopt and use digital systems, while in other some resistance may occur.
- **Environmental conditions:** Access to reliable power supply and reliability of the internet connection.

In general, working with digital records can improve data reliability and access to information, make working processes more efficient, reduce space to store physical files, and increase data recovery. Also, digitising records will reduce the use of paper and other stationary.

Similar to physical filing, digital records should be kept under certain order and logic. Folders and files related to inventory management should follow an agreed standard in terms of name and location, enabling searching for a specific file or group of files. Persons accessing digital files data should be trained in the process, and access granted to only relevant people.

Physical file data management is recommended in temporary setups, such as opening new emergency operation or in locations with unreliable power supply or with limited access to information systems.

Physical records require proper format and labelling, ideally in a standardised manner. A secure but still accessible location should be designated within the storage facility to keep hard files, while files from past periods should be kept aside in a secure place. The time period to be covered for the active physical files should be defined in a coordinated manner with other relevant departments. It is a common practice to make use of natural years, though this may differ depending on the organisation and the type of data. For example, waybills or delivery notes may be archived as per natural years while stock cards may follow a different logic.

When using physical records, consider that carton or heavy paper is more expensive and less environmentally friendly, but more durable during intensive use. It is recommended to use carton or heavy paper for files requiring frequent access and updating, such as stock cards.

Using physical data management formats still require frequent consolidation of stock record information into a system / excel spreadsheet. A daily or weekly consolidation is advised. More frequent consolidation will improve data backup, will provide faster access to information in case of need, and will avoid additional burden in particular periods of the month.

## Coding

Whatever physical or digital file formats are used, a coding system should be in place to ease information flow. Standardised codes and labels serve as a shorthand, or abbreviated item description. The use of codes should speed references to files and entities of interest such as

locations, providers, clients, donors, etc. In addition, a proper coding system will enable data segregation, cross-referencing and ultimately, analysis.

Typical inventory information to be coded is:

- Geographic information: Region, country, district, office, etc.
- Supply chain entities: Suppliers and sources, clients and destinations, departments, warehouses, etc.
- Locations within the storage facility where items may be stored: Rooms, corridors, shelves, stacks, etc.
- Operational information: Program, project, donor, etc.
- Units of measure: "pcs", "Kg", "bags", etc.
- Time scales: Date, year, week, etc.

#### Carton Labelling/Coding

COUNTRY: <b>UGANDA</b>		DEPT.	FSL
YEAR : <b>2011</b>		PROJECT	J3B
MONTH FROM: Jan	TO: Dec	BASE :	LIRA
Code for the box: <b>UG/LI/FSL/00001</b>			

#### Shelf Labelling/Coding

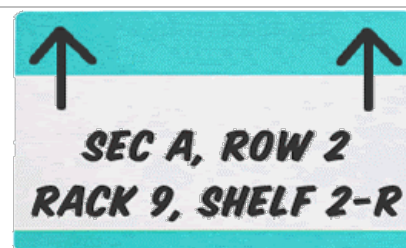

As preliminary step, a consistent, unique and well-organised set of descriptions per inventory function should be designed and agreed upon in advance, including: covered geography, relevant stakeholders, locations, type of stored items, etc. Critical elements to be identified through codes should be outlined. Avoid over-coding: not all the fields above mentioned are always relevant to be coded.

Labels and codes should be easy to read, unambiguous, and harmonisation with other departments and other supply chain units within the organisation. An agency's finance department may be a key collaborator in this task.

The use of codes should be central to inventory management, therefore it should be included in inventory management procedures. Staff should be trained on how to follow codes, making the way inventory is handled and records are kept consistent across the operation.

## Distribution

*" A distribution is the hand-over of commodities to intended beneficiaries, fairly and according to specified rations, selection criteria and priorities. A distribution is the process during which control over the commodity passes from the organisation holding the stock to the intended beneficiary.*

Adapted from [UNHCR, Commodity Distribution](#)

The objective of every distribution is to mitigate the impact on individuals after or during a crisis by providing the means to preserve their health and ensure their welfare, safety and dignity.

Physical distribution is the final step of a product before reaching the final user, however the

process depends entirely on previous activities. This might include decisions about what to procure and how much, transportation, storage and even packaging. It is essential to know as much detail as possible on how any given distribution is going to run to anticipate the possible constraints and challenges and establish corrective measures to mitigate them.

For the purposes of this guide the term distribution does NOT include the process by which commodities are procured, nor the process of transportation, storage and handling, though these are often in some way connected to the distribution process. This guide refers to the physical distribution of commodities at the final handover point.

## Common Terms in Distribution

**NFI** Short for Non-Food Items: Any non-food article, tool, utensil or other item which contributes to the physical and/or psychological health of populations.

---

**PSN** Short for People with Specific Needs: People that we can expect could have special needs are particularly older people, small children, those with impaired mobility or breastfeeding mothers among others that could require any other special assistance or at risk.

---

**Kit** A set of items used for a particular purpose or activity, generally packaged and/or distributed together.

---

**Commodity** A term applied to food and non-food items given in mass distribution.

---

**HF** Short for "Heads of Family", defined as a member of a household that represents it.

---

**Household** A social unit composed of individuals, with genetic or social relations among themselves, under one head or leader, living under the same roof, eating from the same pot and sharing a common resource base.

---

**EDP** Short for "Extended Delivery Point".

---

**IDPs** Short for Internal Displaced Population.

---

## Principles

Although every distribution should vary according to the context and local specifics, there are certain principles that apply to all distributions.

- All distribution should be fair, equitable, regular, accountable, and transparent. Beneficiaries should know the rations they are entitled to, the method of distribution, and the distribution schedule. The more transparent the system, the fewer the opportunities for abuse leading to unfair distribution practices. Those who distribute should be accountable to the beneficiaries as well as to the donors.
- All distributions involve coordination, logistics, monitoring, and reporting, which are carried out by a range of [actors](#); including the government, UN agencies, NGOs, local partners and the beneficiaries. Good management therefore requires appropriate allocation of responsibilities between the different actors, and authority and decision-making must be clearly defined.
- A single controlling authority should be responsible for policy matters, determining overall priorities. Mechanisms for information exchange and coordination between all actors must be well planned. Coordination committees composed of all major actors are necessary both at national level for policy and planning, and in major operational areas for operational decisions.
- There are common elements in the implementation, which include the estimation of beneficiary numbers, selecting the type of recipients, type of beneficiary documents, determining the physical organisation of food distribution, as well as monitoring.
- Information on the beneficiary population is essential for designing a distribution system. No distribution can start without an estimate of the size of the population. The size of the population also influences the choice of recipient and the physical organisation of the distribution, such as the number of distribution points. Knowledge of the sociopolitical context is crucial in deciding [who manages](#) the distribution, or [who should be the recipient](#) of aid, and whether registration by beneficiaries is adequate.
- Beneficiary participation should be encouraged, which can be especially varied depending on if the community manages the entire program or parts of it. [Committees](#) are often recommended to provide a forum for discussion or information on the distribution.
- Access and protection matters must be considered at every stage of the distribution process, from the design of the intervention to the actual handover to beneficiaries, allocating resources and means to these matters. They should be part of the evaluation and reports.

## Fundamentals of Distribution

### Distribution Modalities

When assisting an affected population, delivery of physical goods is not the only possible response. Based on needs, different transfer modalities can be used:

**In-kind** - Beneficiaries receive the goods directly in the form of end products such as [kits and rations](#).

**Cash/Voucher** - Beneficiaries receive a convertible value unit which can be used to acquire the necessary goods.

Cash/ Voucher interventions have unique considerations to be taken into account that are not the purpose of this guide. Information about Cash and Voucher Assistance (CVA) can be found through [The Cash Learning Partnership \(CaLP\)](#) network.

## **Distribution Methodologies**

Generally speaking there are three different methodologies for managing distribution, and while each share the same ultimate goal they have different approaches, methods and objectives. This guide can be used by all the possible actors involved in a distribution, but it is assumed that distribution will be managed by an agency or one of its partners.

### **Government-Managed Distribution**

The government may at different levels be the receiver and distributor of goods, using or coordinating with public distribution systems. For agencies involved in distribution, *"maximum use should be made of existing organisations and structures within the affected localities, with adaptations and redeployment as necessary"* (WFP, 1991). Government intervention frequently involves mechanisms for ensuring price stabilisation, such as sale of food through public distribution systems or subsidised NFI sales through fair price shops. Sale of commodities may be preferential to large-scale free distribution which usually is distributed to selected vulnerable groups through schools, social welfare, clinics, or other common coordination mechanisms.

The extent of government involvement in relief operations varies considerably from one emergency situation to another. Whereas in some countries the emergency response could be entirely in the hands of the government, other governments with lower capacity may be less or completely not involved.

### **Community-Managed Distribution**

A variety of distribution methods have been termed "community-managed distribution". In some cases of community-managed distribution all aspects of the distribution process are managed by the community, whereas in others the community only manages part of the program.

- In entirely community managed programs, traditional leaders register beneficiaries and distribute items to families according to their perception of need.
- In partly community managed programs, community representatives manage one aspect of the program or participate through committees. For example, an agency may register beneficiaries and monitor, whilst the community distributes. Alternatively, community representatives may register beneficiaries and an aid agency distributes. In both cases, committees may participate in planning and monitoring the distribution.

### **Agency-Managed Distribution**

An agency-managed distribution process entails commodity distribution direct to families or individuals by an agency or a trusted partner organisation. Agency-managed distribution requires registration of beneficiary families, sometimes limited to beneficiary lists, but often linked with the issuing of ration cards. A family member may need to present a ration card, ID or some other form of biometric information, and collect the distributed item. The item is usually, measured, weighed or counted by agency staff to match the entitlement and distribution plan.

Many variations on agency-managed distribution systems are possible. A compromise between what is ideal and what is possible may have to be made if no registration is possible.

## Types of Distributions

The context of each distribution informs decisions on the types of distribution that best reach the desired objectives. The contextual factors include the geographic and cultural factors, the type of emergency, the vulnerabilities present in the population, and the nature of the distributed items.

<b>By Set Up</b>	<b>Mobile Distribution</b>	Portable distribution setups usually assembled out of vehicles to assist in multiple locations or areas without a permanent location. <b>Example:</b> <i>Open areas designed with ropes, trucks.</i>
	<b>Fixed Distribution</b>	Permanent or Semi-permanent distribution locations where basic infrastructure will be available for distributions. <b>Examples:</b> <i>MSUs, Community Centres.</i>
<b>By Commodity Type</b>	<b>Recurrent Distribution</b>	The same population is served several times by the same pool of commodities in a well-defined period of time. <b>Example:</b> <i>Food distribution.</i>
	<b>Single Distribution</b>	A group of people or location is served once for the distribution of a specific type of supplies. <b>Examples:</b> <i>NFIs, vaccination.</i>
<b>By Population</b>	<b>Blanket Distribution</b>	In certain geographical locations, all populations within a specific group will receive supplies. <b>Example:</b> <i>Any children of school age receive educational supplies.</i>
	<b>Conditional Distribution</b>	Beneficiaries are selected by specific criteria generally based on vulnerability and needs. <b>Examples:</b> <i>Families with three or more children receive a complementary mosquito net.</i>

## Distribution Systems

Distribution systems can be classified according to whom the commodities are given. There are three broad categories of distribution system.

### Community Leaders

<b>System Description</b>	Commodities are given in bulk to a representative of a group of beneficiaries who further divide it among the group.
<b>Type of situation in which these systems have been used</b>	<ul style="list-style-type: none"> <li>• Early days of an emergency.</li> <li>• Mass influx of refugees.</li> <li>• No formal registration.</li> <li>• Large populations.</li> </ul>
<b>Advantages</b>	<ul style="list-style-type: none"> <li>- Limited staff needed.</li> <li>- Community leadership structures already in place. The beneficiaries themselves can act as monitors of the distribution process.</li> <li>- Can be used in first stages of a large influx with limited space for distribution.</li> <li>- Can be implemented without registration or ration cards.</li> <li>- Distribution is relatively quick to get started.</li> </ul>
<b>Disadvantages</b>	<ul style="list-style-type: none"> <li>- Easy for community leadership and/or the 'strongest' to abuse their position and discriminate against parts of the population.</li> <li>- There may be many levels of re-distribution, from the leadership to many layers of "sub-leaders" until it reaches the individual household.</li> <li>- Distribution may not be equal. Based on the communities' own norms, certain groups or individuals (not at risk) may receive more than others.</li> <li>- Can be difficult for the most at risk to receive proper portions.</li> <li>- Lack of control on beneficiaries' figures.</li> <li>- Difficulty in monitoring the distribution.</li> <li>- If women are not properly represented in the leadership, they may have difficulty of access.</li> </ul>
<b>Prerequisites for Success</b>	<ul style="list-style-type: none"> <li>- Good understanding of the social and cultural dynamics.</li> <li>- Spot checks and monitoring to ensure that distribution is equitable.</li> <li>- A strong information system.</li> <li>- An effective complaint mechanism.</li> </ul>

## Group of Heads of Family

**System Description** All of the commodities for the group of families are handed over to a representative of the group. The commodities are then immediately redistributed to the individual family heads by the representatives.

---

**Type of situation in which these systems have been used**

- When people are settled.
- When registration is done and ration cards are available.
- Homogeneous groups.
- Can be used in camps with small or large populations.

---

**Advantages**

- Promotes social interaction within the refugee community and enhances social adjustment to the new situation and environment.
- Influence over the selection of leaders, or introduce new community leadership structures, ensure the representation of women etc.
- Shares responsibility for distribution with the beneficiaries.
- The beneficiaries themselves act as monitors of the distribution process.
- Requires a small number of distribution staff
- Quick implementation.
- Security problems related to crowd control are minimised by the presence of the family group representatives.

---

**Disadvantages**

- Needs registration and substantial administration to organise family groups.
- An extensive information campaign is needed.
- Best suited for homogeneous group of beneficiaries.
- Needs reliable and verified population figures.
- Abuses by family group representatives may happen.
- Monitoring of the final re-distribution within the groups is needed when this is taking place away from the agency distribution site.

---

**Prerequisites for Success**

- Heads of groups must be chosen by the community.
- Spot checks and monitoring to ensure that distribution is equitable.
- A strong information system.
- Effective complaint mechanism(s).

---

## **Individual Heads of Family**



<b>System Description</b>	Commodities are handed over directly to each family head.
<b>Type of situation in which these systems have been used</b>	<ul style="list-style-type: none"> <li>• Settled population.</li> <li>• Registered population.</li> <li>• Beneficiaries living in camps, settlements or integrated within the local population.</li> </ul>
<b>Advantages</b>	<ul style="list-style-type: none"> <li>- Retain control over the whole delivery process right to family level. This may be important in situations where there are inadequate community structures.</li> <li>- Makes it possible to target at risk groups.</li> <li>- Transparency.</li> <li>- Commodities reach the beneficiaries directly.</li> <li>- Easy to monitor that female headed households, and vulnerable families have proper access.</li> </ul>
<b>Disadvantages</b>	<ul style="list-style-type: none"> <li>- Very staff intensive.</li> <li>- Needs a large amount of infrastructure.</li> <li>- Needs registration and a substantial administration.</li> <li>- Takes away most of the responsibility for distribution from the beneficiaries themselves.</li> <li>- Can be difficult for the beneficiaries themselves to act as monitors of the distribution process.</li> <li>- Not applicable in early stages of an emergency.</li> <li>- Scooping could prove difficult to monitor.</li> </ul>
<b>Prerequisites for Success</b>	<ul style="list-style-type: none"> <li>- Registration and entitlement cards.</li> <li>- Effective complaint mechanism(s).</li> </ul>

Adapted from [UNHCR Commodity Distribution Guide](#)

Distributing agencies should always ensure that those who lack the traditional family structures - such as unaccompanied minors, unsupported elderly or disabled people - also receive assistance, and should establish a distribution system that can accommodate this. This might mean grouping vulnerable people into "households" for the purposes of receiving assistance.

## **Distribtuion Planning**

This guide does not intent to address targeting or the decisions about what to distribute to who and other key questions; there should be a dedicated technical teams specializing in food security, WASH, education, shelter or other sectors that will have better input on these needs. However, due to the multiple activities needed to distribute commodities on time it is recommended to involve logistics personnel in the planning and decision making process. This will assure that what is decided could be feasible and that the decided plan makes sense alongside other logistics plans.

Distribution should occur once clear evidence informs the distribution plan. Unfortunately sometimes it is not possible to wait until full assessments are done, such as in the first phase of an emergency. In these situations, distributions may start without good planning in order to save lives and/or alleviate suffering, however it is strongly advised that some form of verification will still be necessary to ensure that the beneficiaries identified have legitimate need. A proper assessment will still need to be completed as soon as possible, but distributions can potentially start without assessments if planners gradually modify their content and systematisation to align with new evidence and contextual information.

## **Figures**

Knowing how many people are affected by a disaster is essential to plan a distribution, however developing a reliable figure of the people in need is not always easy - wide differences can emerge among the numbers given by the authorities, UN Agencies, or those representatives of the population - and can undergo deep modifications over the time. In major natural disaster, the number of defined beneficiaries can change by the hour; and as time goes on, the initial registration numbers become unreliable because of births, deaths and population movement. Uncertainties about numbers are a constant, but it is key that all partners and key actors understand that the exact number of people in need of assistance will not always be known. As the program develops and more information is available, assumptions will change and distributions will more closely align with the verified needs.

Some form of registration is necessary for all distributions, but the type of registration may vary from simply estimating the total number of beneficiaries, to collecting detailed information on each family and/or individual. The method of registration used is closely linked to the system of distribution adopted, and either communities themselves or external agencies can register the potential beneficiaries of a program. In most programs, the initial list of beneficiaries is produced with the assistance of community leaders or by government officials. Registration is a continuous exercise, requiring regular verification by checking registration data, and comparisons with other estimates of population numbers.

## **Distribution Plan**

A distribution plan needs to consider beneficiaries' interests, security and logistical constraints, the form and frequency of anticipated distributions, the number of individuals who will receive distributions, and the resources available.

If safe, logistically possible, and appropriate for the population, distribution of all items at once or over the course of a single day minimises the cost and effort for the distributing agency. Single distributions are also a more convenient arrangement for beneficiaries who have to travel long distances to reach distribution sites.

In other contexts, a phased approach may be more appropriate, with distribution occurring over multiple days, or even different distributions separated by multiple days. Phased delivery might be due to:

- Distribution space being dedicated to other activities.
- Delays or shortfalls in procurement of distributed items.
- National or religious holidays.
- Insecurity.
- Prior arrangements with beneficiary populations.

A phased approach can still meet the most urgent needs of a population, and focus can be placed on prioritised groups at high risk. A second or more rounds of distributions can then follow accordingly.

A distribution schedule must be designed carefully. It should include a clear schedule of working hours and set a realistic distribution target. The schedule should be shared with logistics focal points for warehousing and transport to ensure that commodities can be prepared and delivered as planned.

A good way of planning the supply movement of a distribution is to roll back the time required for preparation based on an expected day of distribution.

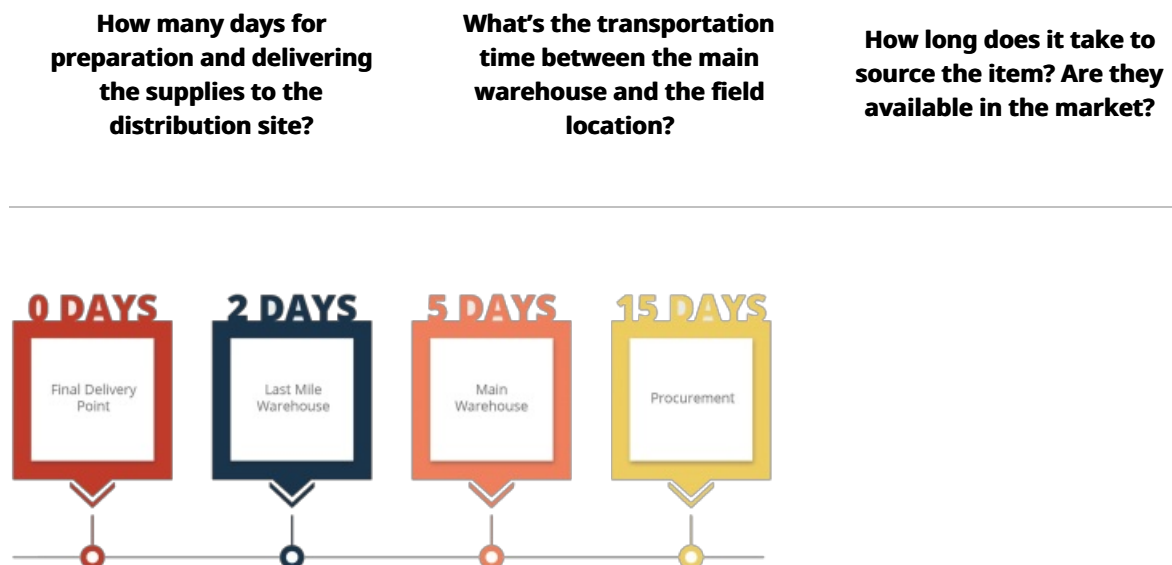

If a distribution is intended on the day D, logistics should trigger the reception at:

$$D - (2 \text{ days}) - (5 \text{ days}) - (15 \text{ days}) = 22 \text{ days in advance}$$

Pragmatism is essential, but problems may arise when the original technical principles are forgotten.

## Main Types of In-Kind Commodities

Because of the different treatment and care required, is common to talk about two main

categories of distributed commodities.

- **Food** - Perishable products for the human consumption - most commonly food.
- **Non-Food Items (NFIs)** - Items that the effected population need to maintain their health and welfare.

## Food

Food commodities are one of the most commonly distributed items in emergency contexts. Not only is food universally required, its consumption is constant and cyclical. Agencies involved in food distribution should develop a plan for distribution based on the types and quantities of food to be distributed.

## Repackaging

Food is often handled in bulky units, either in the form of large sacks of grain weighing up to 50 kilograms, oil contained in plastic jugs or in metal tins, or sometimes supplemental feeding items in smaller containers. Food may also be distributed fresh – such as whole vegetables - depending on programmatic requirements.

Due to the oversized nature of some food handling units, packaging is often broken down and food manually sorted and distributed in smaller portions. Grains from larger sacks can be proportionally weighed or measured and repackaged in smaller sacks matching programmatic targets, while oil tins may be handed out directly or possibly distributed in smaller quantities. The theory behind repackaging:

- No one person will receive excessive bulk or weight.
- Food rations will be evenly distributed among beneficiary populations.
- Limited storage conditions in beneficiary homes/sites of residence might prevent storage of large volumes of perishable goods.

Repackaging food items requires:

- Pre-planning of the size of the new package to match programmatic requirements.
- Sourcing and identification of appropriate containers and materials for repackaging.
- A strategy for how items are repackaged before they reach the beneficiary.

Items that repackaged should be placed into new containers that are sanitary, rugged enough to survive transport, free from holes and/or prevent spillage, and be made of food grade safe materials. Repackaged items may not need to be specifically labelled, but clearly marked containers may make distribution easier. Labels should be clearly legible, and written in at least the language of the beneficiary population.

Due to the size of most food handling units, it is typically easier to bring the larger containers/sacks of grain or oil to a distribution site directly, and conduct repackaging directly before the distribution occurs. To ensure that distribution is not slowed down, persons tasked with repackaging foodstuffs should:

- Be knowledgeable of exactly what the packaging requirements are.
- Have all the necessary tools to complete the job (weighing scales, sanitary food handling gloves, packaging materials).
- Be adequate in numbers to prevent delays in the delivery of repackaged food.

Depending on the context, some agencies may wish to repackage rations before transporting them to distribution sites, which may work for either smaller distributions or distributions that

are planned well in advance. Agencies may also wish to develop repackaging requirements directly into their vendor contracts so that items show up with the appropriate packaging directly to the distribution site.

### Food Items with Dependent Demand

Food items are often distributed with dependent demand – this means they are paired together with different types of food items to complete the full nutritional requirements of the beneficiary population. If items are to be distributed together in complementary fashion, a delay to the proper availability or repackaging of one item may be a delay to the whole process. Distribution planners should accommodate for all food items with dependent demand accordingly, ensuring that all items will be ready at the time and location of distribution in the quantities required by the programme.

If one or more item is not ready or not available at any time, either the entire distribution should be delayed, or those delayed items will be removed from the entire distribution to be distributed at a later day. Delays or omissions should be avoided if possible. Setting up a secondary distribution doubles the logistical requirements, while delaying distribution can directly impact a population’s health, and/or cause serious security incidents. If items are missing or delayed at any time, it must be communicated early and frequently to the community through all available channels to avoid confusion or anger on the day of distribution.

All decisions on portion size should be informed by the sectoral expert in each agency. It is not up to the logistics team to determine what portions members of a beneficiary community will receive. The following is a general guide to ration sizes recommended by different agencies:

Commodity gm/Person/Day	UNICEF	MSF	WFP	UNHCR	Oxfam	ICRC
Cereals	350–400	400	400 (450)	400 (450)	350–400	433
Pulses	50	60	20	60	50–100	133
Oil	20–40	25	25	25	20–40	50
Blended food		100	30			
Sugar		15	20	15		
Salt		5	5	5		
kcal	1,600–1,970	2,260	1,930 (2,100)	1,930 (2,100)	1,510–2,360	2,450

### Non-Food Items

Non-Food Items (NFIs) occupy a broad subset of emergency relief goods, including any

essential goods to protect the beneficiaries from the climate and maintain their health, privacy and dignity. Non-food items are closely connected to all sectors; food, shelter, water and hygiene, health and even the education sector can be supported by NFIs.

It is impossible to make an exhaustive list of NFIs as their nature depends on context, the seasons, type of needs, affected population culture, and other factors. A typical list of NFI items might include:

<b>Shelter</b>	<ul style="list-style-type: none"><li>• Ready-made shelter (<i>tents</i>)</li><li>• Material to build a shelter (<i>ex. plastic sheeting, rope</i>)</li><li>• Material to rehabilitate existing shelters (<i>ex. saw, nails, hammer</i>)</li><li>• Cleaning-up kit (<i>material to clean/clear existing shelters</i>)</li></ul>
<b>Bedding equipment</b>	<ul style="list-style-type: none"><li>• Mosquito nets</li><li>• Bed linen and blanket</li><li>• Mats or mattress</li><li>• Beds</li></ul>
<b>Kitchen utensils</b>	<ul style="list-style-type: none"><li>• Stove for cooking</li><li>• Jerrycan to carry/stock water</li><li>• Pots</li><li>• Plates and cutlery</li><li>• Glasses and cups</li><li>• Plastic basin</li></ul>
<b>Hygiene material</b>	<ul style="list-style-type: none"><li>• Soap and shampoo</li><li>• Toothbrush and toothpaste</li><li>• Hand towel</li><li>• Soap for laundry</li><li>• Razor and shaving cream</li><li>• Comb, brush</li><li>• Sanitary towels and baby diapers</li><li>• Toilet paper</li><li>• Anal cleansing recipient (<i>in countries where toilet paper is not used</i>)</li><li>• Children's toilets</li></ul>
<b>Clothes</b>	<ul style="list-style-type: none"><li>• Gloves</li><li>• Winter hats</li><li>• Scarves</li><li>• Shoes</li><li>• Coats</li></ul>
<b>Heating and lighting equipment</b>	<ul style="list-style-type: none"><li>• Stove for heating</li><li>• Fuel</li><li>• Oil lamp</li></ul>

Adapted from [Pocket guide NFI Distribution, MSF](#)

The overall distribution process of NFI's vary greatly depending on the need, the context and the type of NFI. Much like food distribution:

- NFIs may be distributed as a couple or groups of items that have dependent demand, and all consideration should be made to ensure groups of NFIs should be distributed at the same time.
- NFIs should be a reasonable size and quantity for beneficiaries to safely handle and carry.
- NFIs should be culturally acceptable and in no way increase protection risks for recipients.

Some NFIs, such as plastic tarpaulin, may come in excessively large packaging. In the event NFIs are repackaged or broken down into smaller units, distributing agencies must plan accordingly. Due to the relatively labour intense process of repacking NFIs, and due to the durable nature of NFIs, most agencies may wish to repackage NFIs prior to transporting them to distribution sites. NFIs are typically distributed along programmatic lines, meaning specific sizes are known well in advance. Agencies may wish to conduct a large scale repackaging at once, and keep smaller units within storage for ease of future planning.

### **Kits**

Agencies may wish to combine multiple different NFIs into a consolidated package or set of packages to enable easy and rapid distribution of multiple items covering a variety of beneficiary needs along predetermined lines through a process is known as "kitting". To facilitate the forecasting and final handover activities, (among other parts in the supply chain process) items subject to mass distribution are generally in the form of kits, as for example:

- Shelter Kit for 100 families (*material to build 100 shelters for 100 families*)
- Cooking set (*kitchen utensils for 1 family*)
- Hygiene kit (*Hygiene products for 1 family for 1 month*)

Depending on the time frame, the type of emergency, or the logistical capacities on the ground kits might be built following two different strategies:

<b>Built as...</b>	<b>Description</b>	<b>Advantages</b>	<b>Disadvantages</b>
--------------------	--------------------	-------------------	----------------------

Built as...	Description	Advantages	Disadvantages
<b>Standard Kits</b>	Carefully designed and prepared in advance, standard kits are typically developed based on past experience. A quantity of these kits are sometimes available in large emergency prepositioned stocks, and occasionally large international NFI vendors sell pre-made kits.	<ul style="list-style-type: none"> <li>- Quick response: <ul style="list-style-type: none"> <li>• Ready to use, no assembly needed</li> <li>• Pre-positioned (locally, regionally or international)</li> </ul> </li> <li>- Quality guarantee: the items have been subjected to a strict procedure including market survey, tender.</li> </ul>	<ul style="list-style-type: none"> <li>- Not always adapted to local customs. People may find themselves with material they do not know how to use, and therefore the reason for distributing the articles is not covered</li> <li>- Some articles may turn out to be culturally inappropriate.</li> <li>- Some items are not essential, so people will sell them on the local market.</li> </ul>
<b>Kits locally assembled</b>	Locally manufactured - agencies must identify the appropriate local suppliers, assemble and pack kits as needed. The main advantage is that they can better meet the needs of the population taking into account current requirements and cultural habits.	<ul style="list-style-type: none"> <li>- Highly customisable in terms of items included, packaging and labelling.</li> <li>- More economical: limited or no transportation costs.</li> <li>- Adapted to local customs.</li> <li>- Beneficiaries are more likely used to find all the items locally. the core component products.</li> </ul>	<ul style="list-style-type: none"> <li>- Time consuming: Search for suppliers for the various items (market survey, tender) Assemblage of the kits.</li> <li>- No guarantee of quality.</li> <li>- No guarantee of quick supply in case of emergency.</li> <li>- Often not possible to find all the items locally.</li> </ul>

Adapted from [Pocket guide NFI Distribution, MSF](#)

Sometimes there are circumstances that make it necessary to distribute items in addition to kits. This can be done:

- To meet an urgent need before the kits are available (e.g., blankets in a cold country).
- To meet a specific need (e.g., mosquito nets during a malaria outbreak, soap during cholera outbreaks).



- To meet the needs of vulnerable groups (*disabled, elderly*).
- To complete a standard kit distribution.

Kitted and NFI items are often linked to the central emergency pre-positioning strategy utilised by aid agencies, and both kits and smaller unit NFIs can be developed in conjuncture with a procurement plan. Ideally, vendors will be able to pre-kit items before they arrive at an organisation's warehouse or distribution site, however all or part of the process can be completed prior to arrival, making the overall supply chain process easier.

If vendors are unwilling or unable to meet kitting requirements, then kitting will need to be conducted on the premise of the organisation or its partners. The act of an organisation conducting its own kitting can be very time consuming and require attention to detail. Kitting will need to be formalised well in advance to distribution, but not so far in advance that items inside the kit may expire. Organisations should also account for their own storage capabilities - will they be able to safely store kits matching distribution needs? At what point are they storing too many kits?

Any kit or repackaged item must be transported and and packed in durable overpacking capable of withstanding not only the movement in a warehouse or transport to a distribution site, but also transport back to the home of the recipient and potentially even last for weeks or longer inside a beneficiary place of residence. Overpacking should be able to withstand rips and tears, and even be resistant to water damage. Solutions might include packing kits in:

- Durable cardboard boxes.
- Plastic or woven jute bags.
- Inside of other durable distributed items. Example: items can be packed into standard "Oxfam" style buckets that are not only durable carrying cases, but also part of the kit itself.

## **Before Distribution**

In the days before the distribution, implementing organisations should think about how they will set-up and manage the distribution in a manner that is effective, efficient, safe, and respectful of the needs of beneficiaries.

### **Approach**

The decisions made regarding the distribution approach should take into consideration the information provided by the assessments about needs and size of beneficiary population, including: the types of beneficiaries being served, the number of beneficiaries being served, the existing coordination and community leadership structures, the population literacy level and the security and access situations in the area.

Two questions arise when deciding the system to be implemented:

- How much responsibility is appropriate/efficient/worthy to give to the beneficiaries themselves?
- What kind of resources (i.e., time, space, staff, financial resources) are available to set up and run the system?

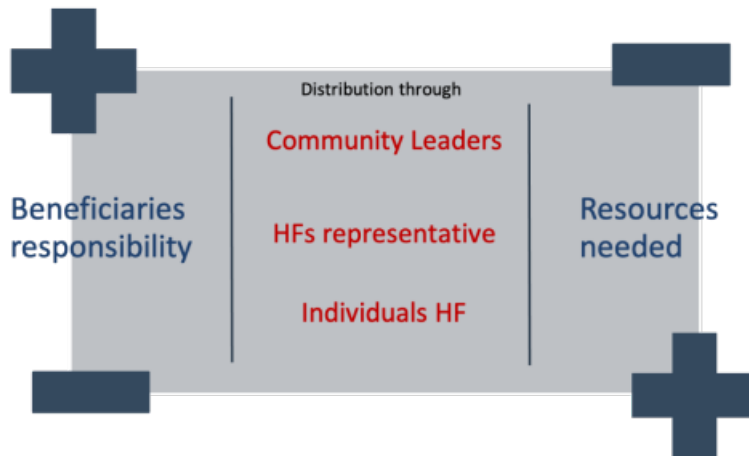

Another key aspect to consider when deciding the approach and setting up a sound distribution system is the access.

Access includes a variety of considerations including how individuals are informed about the distribution, how they will get to the distribution site, how they will transport the aid back to their homes, whether they will feel secure getting to and moving within the site, and whether they know how to use the aid provided. A critical element of ensuring access is the dissemination of information. Beneficiaries must be continuously and directly informed, not just through community leaders, about the distribution process and their entitlements as recipients of humanitarian aid.

Sites should also be established in a way that minimises the number of people who are attending a distribution at any one point, as this can be a critical element of crowd control and in ensuring equitable access to humanitarian aid. One way of avoiding large crowds is to call different communities on different days, while another way is to create multiple distribution points to be managed simultaneously. An organisation’s decision on how to organize a distribution should be based on a variety of factors as detailed below:

	Few distribution points	Many distribution points
<b>Advantages</b>	<ul style="list-style-type: none"> <li>• Need less staff.</li> <li>• Less infrastructure, sites, distribution structures, roads.</li> <li>• Less transport required for distribution.</li> </ul>	<ul style="list-style-type: none"> <li>• Fewer crowd control problems.</li> <li>• Easier access for women.</li> <li>• Shorter journeys home.</li> <li>• Beneficiaries can see the distribution taking place.</li> <li>• Special arrangements easier.</li> </ul>
<b>Disadvantages</b>	<ul style="list-style-type: none"> <li>• Longer journeys to the households.</li> <li>• Potential crowd problems.</li> <li>• Difficult for beneficiaries to see the distribution.</li> <li>• Difficult access for weaker groups.</li> </ul>	<ul style="list-style-type: none"> <li>• More staff and transportation needed.</li> <li>• More structures, roads, access, cleared sites needed for distribution.</li> </ul>

Source: UNHCR

## **Location**

A range of factors will determine the location and number of distributions centres. They include the number of refugees and the number at each site, their locations and the distance between each location, and the availability and location of resources such as storage sites.

As a general rule, it is best to have the distribution points as close to the beneficiaries as possible. For dispersed populations, beneficiaries should not have to travel more than 5 kilometres at a time, however terrain, conditions and insecurity may require that distribution points are established less than 5km. If it is not possible to locate the centre within walking distance, arrangements should be made to transport refugees to and from the centre. In selecting distribution points, factors affecting vulnerable people's physical access should be taken into consideration, such physical security of women who may be threatened, if beneficiaries need to pass near a military/police camp, the ability of disabled people to travel long distances, the inability to travel in the dark. Local tensions between ethnic or religious groups should also be considered when identifying which groups will receive aid in which locations.

The selected location must fulfil some conditions to facilitate the proper set up of the distribution. Distribution sites must be:

- Accessible for trucks or other vehicles used for transporting distributed items.
- Not overly exposed to wind or sun.
- As much as possible free from insects and other vectors.
- Not be prone to flooding.
- Easy to secure and evacuate if needed.
- Clearly marked in the appropriate language.
- Be free from debris or other harmful items.

Ideally, distribution points should be located far away from crowded areas such as markets or hospitals, in enclosed areas such as schoolyards that enable the distribution team to control entry and exit, and avoid over-crowding. Distribution teams can also create their own enclosed sites with stakes and rope or other local materials, in which aid agencies may have to invest in additional crowd-control staff to ensure order within the site. Distribution points should never be in the vicinity of military barracks or facilities, nor should they be in locations that force beneficiaries to travel to or through highly militarised areas.

## **Organising Distribution Sites**

Distribution sites must be constructed in such a way that distributions and the collection of commodities can be carried out safely, efficiently and in an orderly way. UNHCR recommends at least one distribution site per 20,000 individuals and two distribution staff per 1,000 beneficiaries, not including monitors or security staff.

In general, distribution sites should be:

- Secure enough to ensure that items are not stolen or misappropriated.
- Near to water points and constructed with separate latrines for men and women.
- Big enough for on-site commodity storage and shelter for queuing during delays or rain.
- Near to rest facilities for distribution workers.
- Constructed near to vegetation or trees, which provide shade and act as windbreaks.
- Provided with chairs or benches for persons unable to stand in line.

- Safe for women and children.

## Site Layout

The lay out composition of a distribution site will depend on factors including the available terrain, the weather forecasted for the distribution day, the distribution system, the size of the affected population, the available permanent structures. Every distribution site must have:

- Separate entry and exit points.
- A waiting area (*a place in which people can wait before being called for distribution*).
- A separate entrance and waiting area for vulnerable and PSN cases, assuring a protection presence to help identify them and provide referrals.
- A registration area.
- A handover area where people receive items.
- A storage area for the commodities and equipment (*permanent buildings, tent, lorry or clearly marked open space*).
- Staff facilities: latrines and source of water, but also a rest area for a 10-minute break away from the crowd and sheltered from sun or cold.
- Population facilities: latrines, water, covered resting space.
- The presence of a complaints desk, if this is the chosen method for dealing with complaints.

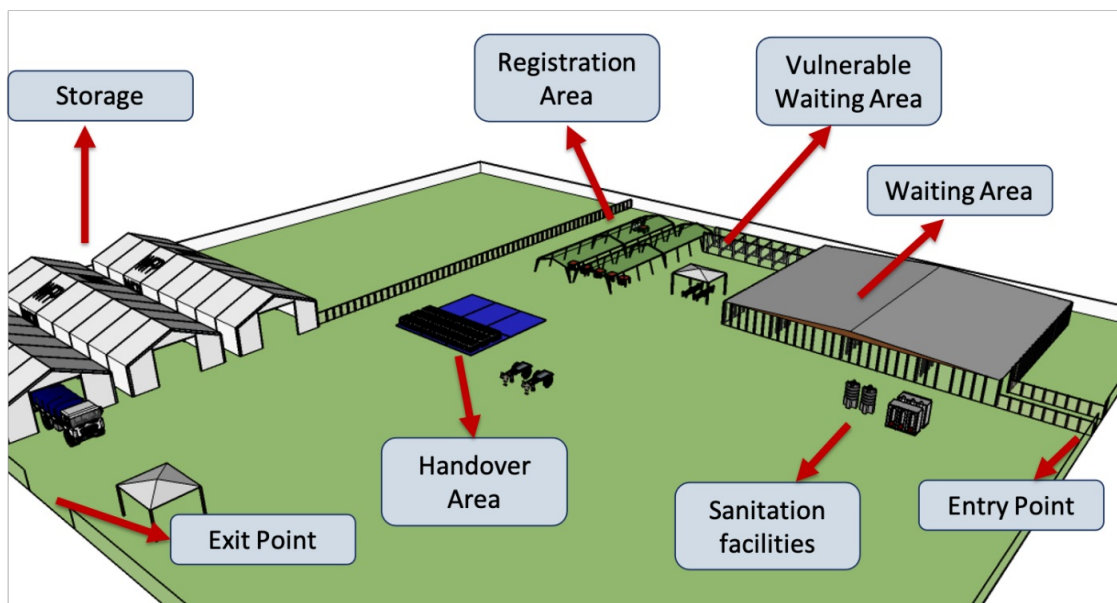

Some of the main characteristics include:









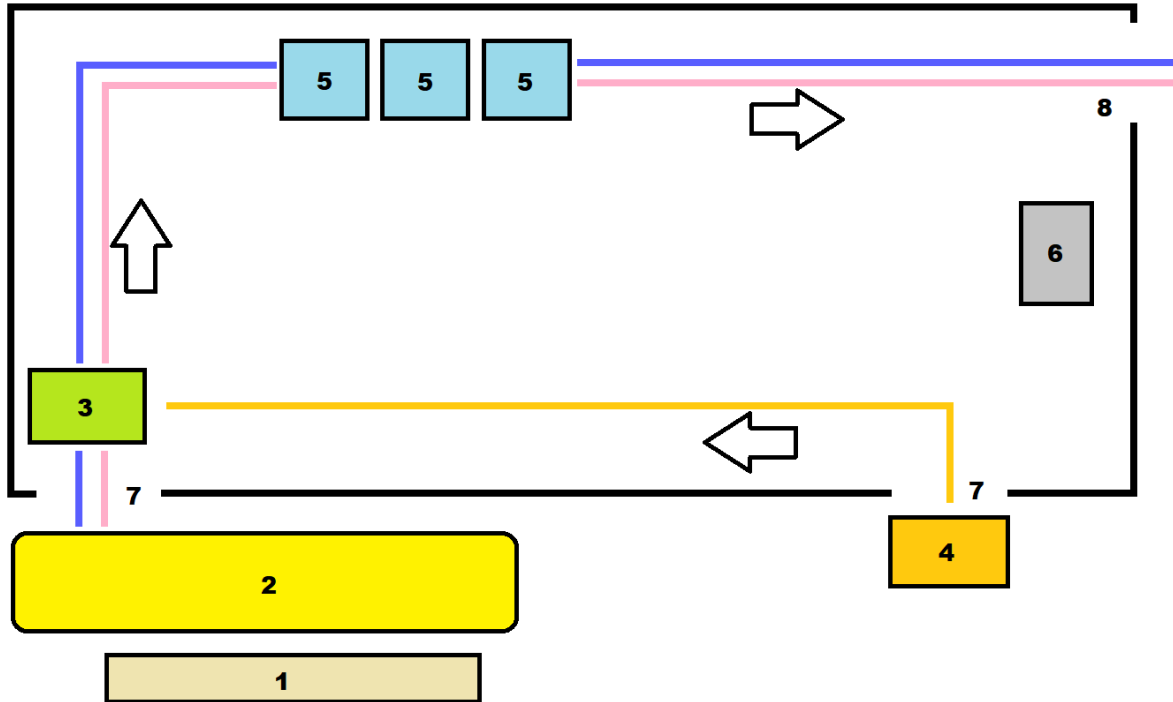

- A clearly delineated distribution space.
- Different lines for men and women if needed and when culturally appropriate.
- A simple structure that facilitates the flow of beneficiaries through the distribution point; progressively organise people into single lines.
- The registration stage can be used to organise the beneficiaries according to the supply types (e.g., grouping different family sizes).
- A one-way flow of beneficiaries: avoid flows of people that overlap or the need to have people moving against the natural flow of distribution.
- Clear space between where people are waiting and the stacks of commodities for distribution.
- The waiting and registration area should be both shaded and have the presence of

bathroom facilities in case beneficiaries have to wait for extended periods of time. Ideally there should be sufficient latrines for the crowd, but this is not practical in view of the large numbers of people assembled on the site. A rapid distribution will help offset the limited shade or facilities, as well as preventing beneficiaries from having to wait excessively long.

- It is important to provide a water source, especially in hot weather.

A general layout might look like:



	<b>1. Facilities</b>		<b>7. Entry Points</b>
	<b>2. Beneficiary Waiting Area</b>		<b>8. Exit Points</b>
	<b>3. Registration Area</b>		<b>9. Male Line</b>
	<b>4. People With Special Needs (PSN) Protection Desk</b>		<b>10. Female Line</b>
	<b>5. NFI Distribution Area</b>		<b>11. PSN Line</b>
	<b>6. Complaints Desk</b>		

### People with Specific Needs (PSN)

An extra effort must be made to assure the distribution is accessible for all beneficiaries and that any potential special needs are covered. Beneficiaries with special needs may include older people, small children, those with impaired mobility, or breastfeeding mothers among others that could require any other special assistance or at risk.

Some measures can be implemented to assure that special support is provided without

marginalising or undermining beneficiaries:

- Remove physical barriers.
- Prepare fast track queues and dedicated waiting areas.
- Train the staff and given resources to assist PSN.
- Facilitate transportation of heavy or cumbersome items from the distribution site back to individual homes with wheelbarrows, donkey carts, or community support groups.

Distribution area with pull carts to assist PSN reach their home location:

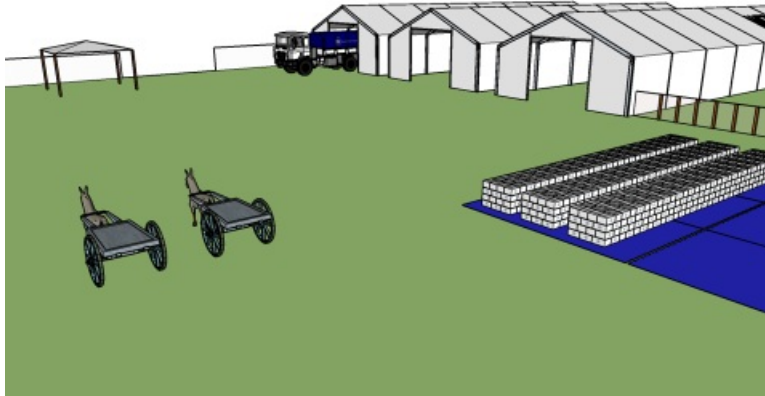

## **Distribution Teams**

The size of a distribution team should be linked to the size of the distribution. Generally, the larger the distribution, the larger the team. At a bare minimum, distribution teams should contain the following:

- A team leader, who will be the primary focal point for communications with community leaders and beneficiaries.
- A logistics focal point to deal with offloading, counting of items, temporary storage, and arrangement of kits.
- A security focal point who is responsible for monitoring the security situation and making decisions, in consultation with the team where possible, on the evacuation of staff and/or abandonment of supplies.
- A complaints focal point to deal with issues on-site as they arise.
- A protection focal point, if possible, to assist in identifying vulnerable cases, facilitating their movement through the distribution point, and referring people for additional services as needed.

The rest of the team will usually be comprised of locally hired individuals who can fill the following roles:

- Translators.
- Crowd controllers.
- Enumerators to support check-in.
- Demonstrators (if necessary, to demonstrate the usage of a particular commodity).
- Off loaders/kit packagers.
- Security, as needed.

All distribution staff should be visible to both other staff and beneficiaries by wearing hats, vests, or other visibility materials, and be provided with the any equipment needed to accomplish his/her work.

Teams should be made up of both genders and be sensitive to the political context by trained and sensitised as well as informed and committed with applicable codes of conduct and protection measures.

The handover of food or commodities is a highly sensitive moment, especially if it is not well managed. Staff must be familiar with the general distribution organisation and understand his/her role, be able to answer questions or how to redirect them, and be instructed to know what to do in case of running problems or major incidents. The staff working on the front line or dealing directly with beneficiaries must receive specific training.

### **Pre-Positioning Supplies**

Sufficient commodities for the distribution ideally should be pre-positioned in the distribution enclosure the day before distribution. The pre-positioned quantities are based on prior calculations based on the number of beneficiaries to be served and the ration agreed upon. Up to 5% extra commodities should be pre-positioned to allow for damages, mis counting or additional beneficiaries.

### **Communicating with Beneficiaries and Host Communities**

Providing the intended beneficiary population with full information before distribution is the key to a successful, problem-free distribution.

The distributing organisation is responsible to duly inform recipient on the basis on what, when, where and how items will be distributed, and what criteria determines who will obtain items. The rationale employed will be different in the first phases of a rapid onset emergency than it will in longer protracted crisis. The key for any agency is to find the best approach to reach the affected population assuring that every vulnerable individual have as much accurate information as possible about the distribution.

Pre-distribution announcements should:

- Reach out to all different groups of the population using multiple channels of communication.
- Particularly involve women and the distribution committees (if already in place) in order to avoid information going out only through the community leaders, who might have their own political agenda.
- Use different methodologies and means such as meetings with groups of beneficiaries (including those at risk), posters and picture messages, information boards, radio, megaphone and others.
- Use the local language and reach out also to those who are non-literate.
- Allow them to fully understand the messages and give feedback.

During an information campaign, it is needed to indicate clearly:

- Distribution is free of charge.
- How refugees can report any abuses by the staff who manage distributions.
- Who will receive the commodities that are to be distributed, and selection criteria (if relevant).
- What items refugees are entitled to receive (quality and quantity).
- When distributions will occur (date and time).
- The location of distribution centres and the areas (populations) that each will cover.
- How distributions will be organised and how those who receive distributions should behave.

- The purpose and use of the items distributed (to avoid misuse or undesired effects).
- When future distributions are planned, and their frequency, so that refugees can plan ahead.

### **The Day Before the Distribution**

Prior to the launch of the distribution, the team needs to ensure that all structures, commodities and equipment are in place and that operating procedures are clear; this can help to expedite the distribution process and reduce the chances of disorder or problems at the site.

The team leader must ensure that everyone involved in the distribution knows their role, what is expected from them, and have enough knowledge about the exercise itself. A briefing to the core team is mandatory, and detailed briefings should be given to specific staff, such as those persons involved with crowd control, registration team, or complaint mechanism.

The Shelter Cluster has developed a check list as a guide:



### ***Checklist for the Day Before the Distribution***

---

- The team leader should brief the core distribution team on the following:
    - The number and type of items to be distributed per household.
    - Each team members' specific role during the distribution.
    - The distribution process (a walk-through of the site).
    - The start and end times each day, as well as any breaks (i.e. lunch), as agreed beforehand.
    - The complaints mechanism.
    - How issues or concerns should be raised throughout the day.
    - Means for feedback on the process; e.g. evening meetings to discuss how the distribution is going, any issues, gaps, etc.
  
  - Ensure organisers have the necessary enrolment lists for the first day of the distribution.
  
  - Ensure that all team members have functional communications equipment (VHF radio, mobile phones, etc.), and that all team members know how to reach each other.
  
  - Ensure that all needed local staff including daily labour have been identified and are aware of responsibilities and start/end times each day.
  
  - Confirm that the beneficiaries have been notified of the distribution, as per the plan.
  
  - If possible, pre-position all supplies in the right quantities at the distribution site (or nearby); the distribution organisation may need to hire security to watch the items overnight.
  
  - Have the following items ready for the distribution (as needed):
    - Drinkable water for the distribution team
    - First Aid Kit
    - Ink pad
    - Cutter/knives (for stock)
    - Megaphone (if needed)
    - Pens
    - Masking tape/extra rope
    - Flag or visibility materials, if available
    - Vests or arm bands for casual workers
    - Empty enrolment forms, if applicable
    - A hole punch
    - Table and chairs for staff and vulnerable people
  
  - If applicable, ensure that vehicles are filled with fuel and in good working order.
  
  - If applicable, ensure that the equipment above has been loaded into the vehicles.
- 

*Adapted from Shelter Cluster, Guidelines for the distribution of Shelter/NFI kits*

## **Day of Distribution**

Once all the members of the distribution team are in position on the day of distribution, all possible questions or concerns from staff are addressed, the commodities are in place and

beneficiaries have been assembled in the waiting area, the distribution can begin.

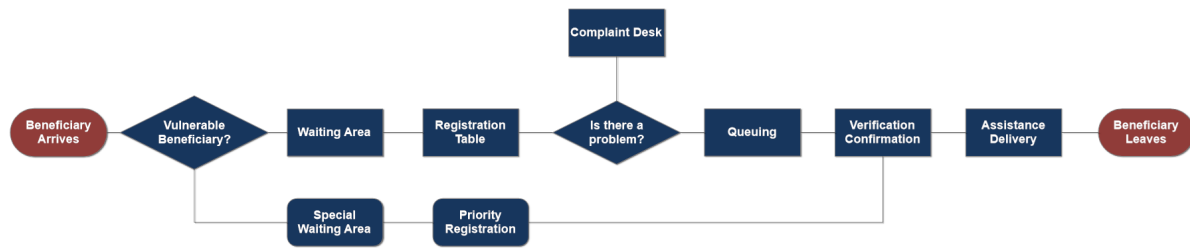

## Registration/Verification

The first step during the distribution is the registration and control of beneficiaries. Registration is the stage where intended beneficiaries are confirmed as eligible. It is also the moment when the distribution team can ensure the distribution is documented and that the resources distributed have an identifiable beneficiary at the end of the chain.

Three different methodologies for registration exist:

- Manual Distribution Lists
- Distribution Cards
- Biometric/Digital Control

In order to prevent duplication and omissions of records, it is preferable that the registration and verification take place at the same time, assuring a proper segregation of duties between different parties. Programs with limited staff will often combine the process of collecting, processing and verifying registration data into one team. To minimise data manipulation and fraud, however it is important to segregate these tasks.

The staff responsible for registration/verification must assure the following steps:

- Train personnel involved in registration process, define team composition and division of tasks, consider potential challenges between the information collectors and respondents (such as language barriers and gender norms).
  - Define roles and tasks (data collection, data cleaning, data processing and backing-up) in standard operating procedures (SOPs).
  - Train teams on all elements of the participant registration process: data protection principles, informed consent and workflows.
  - Explain the registration objectives and highlight any data security risks and mitigation strategies.
  - Introduce SOPs and applicable protocols.
- Conduct a post-training skills check and address any knowledge gaps.
- Monitor the registration process and provide mentoring and feedback. At the beginning of the registration process, teams should regularly check the quality of data collected (i.e., blank fields, differing usage) to identify any gaps.

## Manual Distribution Lists

Largely used for small to medium sized distributions in “one shot” interventions designed to tackle a specific need. This methodology consists of the collection and registration of beneficiary information manually on paper using a standard form to capture basic data. This simplified process facilitates the implementation and flow of ad-hoc/first time distributions, however, all the information gathered should be cleaned and processed manually at a later stage; as manual registration is prone to human error, the monitoring/reporting process may

become cumbersome.

A manual distribution list will likely only contain beneficiary names and some household information, but no quantitative way to track individuals. Ideally, beneficiaries should produce some form of ID to match the list, but this is not always possible, especially in the early stages of an emergency. The manual list method also frequently utilises fingerprints or a signature as verification source, which cannot be verified in real time and largely can only be used for resolving claims of fraud or misuse after the fact.

## **Distribution Cards**

Distribution cards are commonly used in camps or in situations in which cyclical distributions are common. Distribution cards are also useful when the beneficiary list is consistent. This methodology utilizes the creation and distribution of cards made from plastic or some other durable material. To facilitate this, organisations involved with distribution will intentionally identify Individuals or families who frequently receive distributed items though a formal registration process, and provide each individual or family with a distribution card. Distribution cards might include a serial number or ID code that refers to specific households containing all the information gathered during registration. The serial number or ID codes and correlating beneficiary information are maintained in separate system, usually an electronic database through which numbers can be quickly searched. Paper lists might be used in some situations where a computer database isn't accessible, but it is important that paper lists contain ID or serial numbers, and that data captured at the point of distribution is re-entered into a database later.

While a card system will require some investment on databases as well as time to gather information, prepare, issue and distribute the cards, this methodology greatly facilitates the registration process, especially if the card can be read by a bar-code or similar machine. Cards should ideally be accompanied by another source of verification at the time of distribution to assure the beneficiary identity.

## **Biometric/Digital Control**

Biometric registration refers to the process of tracking recipients of distribution using unique biometric features of individuals. Biometric features might include fingerprints, eye, or facial features, all of which is automatically captured by recognition software and linked to the individual with a server-based database of beneficiaries. A biometric database might even be used at different geographic points if the beneficiary is migrating or mobile. While many biometric tracking systems are still developing due to high levels of sophistication and data management required, the use of this technology is increasing. A biometric system not only reduces input and duplication errors, but they also facilitate update, back-up, reporting, monitoring and auditing controls.

Any time biometric data is used to track beneficiaries, organisations should consider social and political implications of biometric tracking, and place protection concerns at the highest level. Information that can track an individual across multiple locations and time can also be used to target vulnerable persons, and may be the subject of scrutiny by law enforcement, armies and even non-state actors. Before implementing a biometric registration process, agencies should consult with protection professionals about concerns, and with local government bodies about laws governing gathering biometric data.

## **Safety**

Security measures used in a distribution should be defined according to the risks involved. These risks can go from small-scale robbery to large-scale coordinated attacks and the same activity in different places will have different risk factor.

Distribution sites can quickly become chaotic, crowded and potentially dangerous places to both field staff as well as beneficiaries, particularly when there are long wait-times or commodity shortages. Security at distributions is usually the responsibility of government authorities. However, in some conflict situations, local law enforcement authorities cannot be viewed as neutral, and other crowd control mechanisms may be necessary. Once serious disorder has broken out there is little that humanitarian actors conducting distribution can do except to ensure the safety of the distribution staff, usually through evacuation.

Distribution teams can often prevent these situations through good site selection and design, through following operating procedures, and by positioning sufficient and trained crowd control personnel strategically throughout the site to facilitate flow, minimising long waiting periods to the extent possible, and dealing with fraud or cases of cheating in a quick and transparent manner.

During a distribution plan, program, logistics and security teams should work together to define such rules.

- The first layer of a security mitigation measure is community involvement: it is key to have local leaders supporting to spread the distribution rules and criteria. Special teams that communicate with communities also play a critical role in informing people about the activities and criteria of assistance.
- The presence of security forces should respect a strict progressive use of force approach when managing crowds. Force should only be applied when absolutely necessary, and in accordance with the level of threat.
- Have a prepared contingency plan and an evacuation strategy.
- Information is key: good visibility and constant community engagement help to keep people under control, especially in the case of shortages or changes in the food basket or distribution systems.
- Mind people's minimum comfort needs: water, shade, access to sanitation.
- Appoint one person to be responsible for security decisions on the spot. Make sure that all other staff are aware of which person it is. He/she should be easily visible.
- Provide staff with communication means like radios, whistles or establish another method to signal an emergency.

## **Complaint/Feedback Mechanism**

It is important to acknowledge beneficiaries' concerns and complaints while referring those with specific problems to access the distribution services. A complaint or feedback system must be in place, ensuring complaints are recorded, documented and are addressed accordingly. A help-desk should be visible and be accessible without impediments, but also be away from the waiting area to ensure privacy and personalised support. It is advisable to appoint a representative from the distribution committee in the help desk. Any help desk should be able to converse in the language of the recipient population, and ideally be taken from the local community

It is important to differentiate between complaints and questions. Throughout a distribution, staff will very likely be approached by beneficiaries, authorities or others arising issues as:

- Lack of familiarity with distribution procedures and location.
- Lost, missing or incorrect ration cards.

- Faulty items or bad quality food.
- False claims in order to receive more items or food.

It is strongly recommended to brief the staff closest to the crowd about how to deal with questions and how to refer them to the help-desk if necessary. Efficiently responding to questions and complaints will have direct impact on the number of security issues likely to further arise.

## **Closure / After Distribution**

Distributing organisations are also responsible for the proper closure and clean-up of a distribution site. Generally, this includes clearing the site of any refuse, resolving any outstanding issues, compensating casual labourers, and putting a plan in place to report on and monitor the results of the distribution.

### **Reconciliation**

After the distribution, warehouse and distribution teams should reconcile and agree upon the correct number of items dispatched and distributed, spotting problems such as: excess distribution and mistakes on waybills, registration problems and thefts, or other discrepancies. The shorter the time between activity and reconciliation the easier it will be to find mistakes. The distribution team will need to submit an activity report which requires the use of warehouse data and the reconciliation is a mandatory part of the process.

All the below figures should account for:

- Amounts dispatched from the source and received at the distribution point.
- Amount distributed.
- Balance left after distribution/showing as a return from distribution.
- Balance recorded at source following reception of returns.
- Any registered losses.

### **Reporting**

After a distribution, it is essential that a distributing organisation report internally and externally on the intervention and its results, allowing all stakeholders to know results, including shortfalls or gaps in numbers of population served. In general, every report should include information on which commodities were distributed, in what quantities, to which populations, in which areas, and in what time period. If all of the needs of the community were not met during the exercise, it is suggested that the distributing organisation include the percentage of total needs met. Any problems that occurred during the distribution should be noted, particularly if they may impact the ability of partners to operate in the area moving forward. Photos with captions should be attached to the report, where possible.

In order to consolidate the different reports is a good practice to agree and use the same template every time. The Shelter Cluster designed one that contains the following information based on UNHCR templates:

Item	Description
<b>Distributing Organisation</b>	Fill in the name of the organisation that organised the distribution.
<b>Site(s) and Location</b>	Fill in the name of the distribution site (e.g. Name of a School) and its location (governorate, district, village/neighbourhood).
<b>Date(s) of Distribution</b>	Give the exact dates of the distribution, inclusive (e.g. January 4-7, 2017).
<b>No of Beneficiaries</b>	Give the total number of beneficiaries served through the intervention, disaggregated by gender and age.
<b>Rations</b>	Specify what each household was meant to receive, including whether different packages were delivered to different sized families (e.g. 3 blankets/family of 6, 1 bar of soap/person).
<b>Initial Stock Count</b>	Give the number of items delivered at the outset of the distribution, listed by item (e.g. 1,000 blankets, 1,000 mattresses, etc.).
<b>Stock Distributed</b>	Give the total number of items distributed, listed by item (e.g. 850 blankets, 850 mattresses, etc.).
<b>Remaining Stock Count</b>	Give the number of remaining items, if any, listed by item (e.g. 150 blankets, 150 mattresses, etc.). Ideally, this number will equal the initial stock count minus the stock distributed.

Item	Description
<b>Percentage of Needs Covered</b>	Give an estimation of the needs covered. If there was a shortage of stock, then this number will be below 100%. Similarly, if there are new arrivals, the team might note that the needs as per the assessment have been covered but that new needs have arisen.
<b>Distribution Approach</b>	Detail how the distribution was set up and managed.
<b>Problems Encountered During the Distribution</b>	List any problems encountered during the distribution such as fraud, issues of access, claims of exclusion, etc.
<b>Plan for Follow-up</b>	List any actions that the organisation plans to undertake in the aftermath, e.g. a PDM or a follow-up distribution to account for new arrivals.

## Evaluation

Following the full closure of a distribution, distributing organisations may want to start thinking about conducting a post-distribution monitoring (PDM) exercise in order to assess the effectiveness, appropriateness and coverage of the intervention, and overall satisfaction with the assistance provided. Ideally, PDMs should evaluate a single response about a month after the intervention occurs. This allows time for beneficiaries to use the items provided and give useful feedback on quality, and account for the possibility that the recipients of aid might have moved.

In parallel, agencies may wish to perform a market survey where the price of commodities on the local markets is collected regularly. The market tends to be distorted in emergency or conflict contexts, and there can be large fluctuations in price provoked by the timing of distributions making very difficult to interpret quantitative data. Market surveys may reveal impacts of distributions on local vendors, if items are being resold, or even if cheaper or more appropriate items are available locally for procurement or cash vouchering.

## Distribution Community Involvement

### Key Actors

It is important to know the roles and responsibilities of the main actors involved at various stages of commodity distributions. In most circumstances, key actors include the following:

- Affected people: IDPs, returnees, host communities or other potential recipients of aid.
- Distributing agency: Agency, NGO or any of kind of partner conducting the distribution.
- Donor or Contributing Organisation: Agency contributing with stock, funds, or other kind of support to the distribution.
- Government authorities: local or national authorities covering the area of intervention.
- Cluster: coordinating body that can assist in the organisation of the intervention.

The roles and responsibilities of each of these key actors may include:

Actor	Roles and Responsibilities
<b>Affected People</b>	<ul style="list-style-type: none"> <li>• Assistance in distribution planning.</li> <li>• Assistance in the identification of people at risk.</li> <li>• Establishment of committees with adequate representation of women.</li> <li>• Information-sharing on the specific concerns of different groups.</li> <li>• Dissemination of information on the commodities and the distribution process and system.</li> <li>• Crowd control at the distribution site and other casual labour for distribution related activities.</li> <li>• Assisting vulnerable members of the displaced population.</li> </ul>
<b>Distribution Agency</b>	<ul style="list-style-type: none"> <li>• Establishment of distribution site and distribution-related processes.</li> <li>• Dissemination of information to affected populations.</li> <li>• Management and equitable distribution of relief commodities using the appropriate distribution system.</li> <li>• Participation, inclusion, safety, and accountability in the distribution process.</li> <li>• On-site monitoring of distribution processes.</li> <li>• Reports on quality, quantity and impact of commodity distributions.</li> </ul>
<b>Donor or Contributing Organisation</b>	<ul style="list-style-type: none"> <li>• Movement of stocks to the field for distribution (if applicable).</li> <li>• Provision of funds or other types of support for the intervention.</li> <li>• Guidance on technical issues where appropriate, e.g., protection referrals.</li> <li>• Monitoring the distribution program and reporting to donors and governments as relevant.</li> </ul>
<b>Government Authorities</b>	<ul style="list-style-type: none"> <li>• Security and the creation of safe spaces for distribution.</li> <li>• Creation of initial beneficiary lists in consultation with communities (when appropriate).</li> <li>• Free and safe access of relief personnel to beneficiaries and of beneficiaries to aid.</li> <li>• Consultations on distribution set up, approach, and process.</li> <li>• Relevant permissions.</li> </ul>



Actor	Roles and Responsibilities
Clusters	<ul style="list-style-type: none"> <li>• Coordination of the distribution and support for additional capacity if needed.</li> <li>• Advocacy around access.</li> <li>• Receipt and review of distribution reports.</li> <li>• Information management</li> <li>• Creation of intersectoral coordination spaces.</li> </ul>

*Adapted from Shelter Cluster*

## **Distribution Committees**

To assure the affected population involvement in the process and guarantee that its participation is efficient and effective, a best practice has shown to be the creation of distribution committees. Distribution committees tend to work better in stable environments, should ideally reflect the ratio of men and women in the population, and all population groups should be represented. Committees can meet both before and after distributions, where all issues related to distribution should be discussed freely inside the committee and brought to the appropriate agency's attention. These committees will act as a link between the agency in charge of the distribution and the affected population, helping to:

- Keep unrealistic expectations in check.
- Ensure overall understanding of procedures and restrictions.
- Ensure receipt of feedback from the community or camp population on all issues related to distribution.

## **Protection Considerations**

Protection mainstreaming means distributing organisations, partners, employed third parties and all other entities involved in the distribution are undertaking activities in a manner that safeguards people from violence, coercion, deprivation, and discrimination.

The distributing organisation should undertake all effort to integrate protection into every part of the distribution process incorporating the four key elements of protection mainstreaming, which include:

1. Avoiding causing harm and prioritise safety and dignity.
2. Ensuring meaningful access.
3. Practising accountability.
4. Promoting participation and empowerment.

A protection-based approach should be included when planning the logistics of distribution to advocate and highlight the importance of impartiality and non-discrimination to achieve a successful and sound distribution. All members of the team have a role in ensuring the safety, dignity and integrity of people in aid distribution. Coordination, fairness and planning are crucial to respond to their specific needs, cultural values, physical context and environment preservation.

As a compendium, the following list should be considered:

- Distribution times are safe for beneficiaries to travel to the distribution point and return home without exposure to further risk of harm.
- Physical location of the distribution can be easily and safely accessed, particularly against the risk or threat of gender-based violence and attacks from armed groups.
- Commodities distributions are designed to be respectful and inclusive of cultural and religious practice.
- Commodities distribution methodology are designed to preserve safety and dignity.
- Options for home delivery of shelter materials/NFIs for vulnerable persons (e.g., persons with disabilities who cannot access the distribution point, elderly, child-headed households, etc.) or systems by which representatives can collect assistance packages on their behalf.
- Commodities are packaged in a way that avoids injury or strain to beneficiaries. Distributed items should not be of excessive size or weight, and should be easy to manage for elderly or persons with disabilities.
- The provision of additional NFIs essential for personal hygiene, dignity and well-being, including sanitary materials for women and girls are consistent with cultural and religious traditions.
- Complaints mechanisms and monitoring are integral to the distribution plans.

## Distribution Tools and Resources

### Sites and Resources

- [Sphere Project, Handbook \(2018\)](#)
- [Universal Logistics Standards \(ULS\) Handbook](#)
- [UNHCR Commodity Distribution Guide](#)
- [The Cash Learning Partnership](#)
- [PARCEL Project](#)
- [Humanitarian Logistics Association](#)
- [Core Humanitarian Standards](#)
- [Overseas Development Institute \(ODI\), General Food Distribution in Emergencies](#)
- [Norwegian Refugee Council \(NRC\), Camp Management Tool Kit. Food distribution and Non-Food Items](#)
- [Medicins Sans Frontiers \(MSF\) Pocket Guide NFI Distribution](#)
- [OXFAM NFI Distribution](#)
- [IASC Gender and NFI in Emergencies](#)
- [WFP Emergency Field Operations Pocketbook](#)
- [UNHCR Guidelines for Reducing Protection Risks in in-kind Distributions](#)

### Monitoring and Evaluation

The purpose of logistics in humanitarian organisations is to make people, processes and systems work together to support the efficient and effective delivery of goods and services.

Monitoring and evaluation (M&E) are integral parts of the logistics management process and provide a link between planning and implementation. While monitoring focuses on the activities organisational logistics perform and their outputs, evaluation focuses on the outcome and goals achievement.

## Definition

**Monitoring** is the continuous process of gathering logistics and programme information to measure against previous base-line indicators that are aligned to the goals and objectives of a program. A continuous review of the degree to which a logistics activity is completed and if its objectives are being met allows for corrective actions to be taken.

**Evaluation** is the continuous measurement process of the quality of the output a logistics function or service provides to analyse progress towards meeting established objectives and goals. Evaluation should be undertaken in such a way that shortcomings can be identified and corrected. It is done on an ad hoc, monthly, quarterly or yearly basis.

Evaluation should also continuously feed into the planning process so that the planned method of intervention can be modified to adapt to the realities and conditions on the ground. Evaluation provides feedback on whether plans have been met and the reasons for success or failure, providing a tool for management to ensure that focus is maintained.

## Objectives

M&E has several purposes:

- Provide information to logistics managers on the capacities they have.
- Identify problems in supply chain and entire logistic systems.
- Determine what measures are needed for improving logistics performance.
- Understand the need to increase or decrease resources.
- Make an objective assessment of minimum and maximum logistics capacities in a context.
- Objectively measure achievements and failures.
- Define parameters for the periodic review of measurement calculations.
- Identify internal gaps, bottlenecks and misunderstandings.
- Evaluate performance of individual staff members, locations, or functions.
- Motivate logisticians.
- Serve as a basis for formulation of an internal logistics strategy.

## Users of Logistics Services

For the purpose of this document, a user is the final recipient or the identified final beneficiary of the logistics activities and services. There are two sets of users:

- **Internal users** are a department or individual within the same organisation as the logistics service provider.
- **External users** are the beneficiaries in the communities that the organisation serves.

## Monitoring of Logistics Performance

Logistics includes a wide-reaching set of concepts that can encompass several aspects, from procurement to distribution, the entire supply chain or the fleet, energy or premises management can fall under the logistics responsibilities.

Each section of this guide contains information on how to monitor and ensure the quality of the service provided by each respective function of logistics. Each individual tool provides information on specific parts of the process, while a wider and holistic monitoring system should be adopted to form a complete picture of the logistics performance as a whole.

Monitoring and Evaluation Tools in this Guide:

<b>Thematic Area</b>	<b>Specific Monitoring Information</b>
<a href="#">Vehicle and Fleet Management</a>	<a href="#">Fleet Performance Monitoring</a>
<a href="#">Inventory Planning and Management</a>	<a href="#">Inventory and Stock Level Monitoring</a> <a href="#">Systematic Recording and Support Documentation</a>
<a href="#">Warehousing and Physical Stock Management</a>	<a href="#">Physical Documentation For Warehouse Monitoring</a>
<a href="#">Electrical Power Generation</a>	<a href="#">Generator and Solar Electric Monitoring</a>
<a href="#">Health Supply Chain</a>	<a href="#">Cold Chain Monitoring</a>

## What to Monitor

If efforts are made to establish a monitoring system, it is better to ensure that the M&E process or activity is important to the continuity of the logistics activities and will have an impact on overall performance. A thorough analysis of the context, objectives, desired outcomes, and organization goals will help to properly define the specific aspects to monitor in depth. The following are some of the aspects that can be monitored in a logistics activity.

### Delivery Lead Time

**Lead time** is the time between placing an order and receiving the goods or service. In disaster/emergency relief situations, timing of delivery can have a serious impact on the relief operation and on the beneficiaries.

- Delivery of items *too early* or too late may also incur unnecessary costs. Delivery too early can mean goods have to be stored until they are needed and will incur additional costs whilst being stored or managed.
- Delivery of items *too late* can mean the costs of setting up facilities, for example feeding stations and having people ready to distribute goods, is wasted due to the fact goods have not been delivered. Delayed delivery can also cause the organisation to incur additional transport costs, if specialty transport arrangements such as aircraft have to be used to move the goods more quickly along the supply chain.

### Order Information

The internal performance of a logistics function is dependent on the efficiency and effectiveness of each of the individual logistics components. For example, one performance indicator for procurement might be the ability to disseminate information on the number of orders issued. Knowledge of pending orders will allow the warehouse to plan for storage space, while unexpected deliveries can disrupt operations.

### Efficiency

The measurement of efficiency is sometimes relative and dependant on what an entity defines as efficiency. In logistics management, efficiency is the satisfactory delivery of a logistics service that enables the end user to fulfil the intended purpose of the request. A good example is the request for medication to be pre-positioned before a malaria season. A late delivery

would mean higher incidents of malaria and an increase in the request for malaria treatment rather than malaria prevention drug.

## **Total Costs**

The concept of “total cost” focuses on reducing the total cost of logistics rather than the cost of each activity. An organisation should monitor cost reduction across the board and evaluate the impact on each of the logistics components. For example, purchasing in bulk may reduce the cost of the product but at the same time increase the stock holding costs.

## **Inventory Costs**

Inventory carrying costs include:

- Inventory service costs - insurance and taxes.
- Storage space costs - leasing costs or land rates.
- Inventory risk costs - costs related to pilferage, the risk of goods being kept so long that they become obsolete, the risk of damage.
- Carrying costs - the cost of storing - labour, asset/item depreciation, and other overheads.

## **Inventory Value**

In recent years the concept of value has become accepted as the difference between the value a customer attributes to a product or service and the cost of acquiring the item. Excessive stock holding is not only a risk in emergencies - in the event of an evacuation stocks may be abandoned - but also not cost effective when money is tied up in dormant stocks that may not all be utilised within reasonable time, or used at due to rapidly changing needs. Monitoring and collaborating closely with programs on distribution rates helps in balancing the benefits. Storekeepers are encouraged to share [monthly stock reports](#) with stakeholders so they may know what they have in their possession.

## **Order Management Costs**

Order management costs include those costs incurred for issuing and closing orders, the related handling costs, and the associated communications costs. In other words – the staff and infrastructure costs associated with placing orders, and not just the costs of the items themselves. How many cumulative staff hours does it take to complete a single order, multiplied by their hourly salary? What about the costs of maintaining communications systems and renting office space? It is advisable to benchmark these and keep them under close monitoring to ensure that service delivery is cost effective.

## **Cost of Waste**

The cost of waste covers the cost of disposing of item packaging, disposing of spoiled, expired, recalled or damaged relief items, or of disposing of damaged, unserviceable equipment. Waste disposal costs have sharply increased due to environmental impacts and national regulations. An overview of environmental cost can be seen in the [Sustainable Logistics](#) section of this guide, while information on disposal and national regulation can be seen in the [Warehousing Section](#).

## **Key Performance Indicators (KPIs) in Logistics**

A useful way to measure performance is through the establishment of indicators for the key

aspects of logistics activity, with the goal of evaluating the success of an ongoing process or particular activity.

Key Performance Indicators (KPIs) are quantifiable measurements of performance for key activities managed by organization or team. These include all the activities that are needed to keep an operation functioning on an ongoing basis.

A KPI consists of the following elements:

- **Identified Metric** - Anything the organization chooses to measure is a metric. There are some metrics that the organization or teams classify as “key”, those are the ones that becomes KPIs.
- **Ongoing Value** - The ongoing value is the running value of the defined metric when is measured at any given moment.
- **Target Value** - The target value is the minimum or maximum desirable value for the identified metric.
- **Unit of Measure** - The unit of modality of measurement and organization chooses to view and track an activity.
  - Numerical – a flat number that indicates a target number – Example: Number of beneficiaries receiving commodities.
  - Percent – a measurement of an activity as a percent of a whole – Example: % of orders delivered on time.
  - Rate – a measurement of activity referenced against another number – Example: dollar value per metric tonnage stored.

All the information needed to understand the KPI units of measure need to be clear for everyone involved, and when two or more variables are measured, this needs to be clearly defined.

By setting the KPIs, the *key areas* of the intervention are defined, using a predefined metric (as well as a target value) to *indicate* how that *key area* is *performing*. Thus, KPIs are used to measure the health of an organization and its respective teams and departments. KPIs are often thought of as “health metrics” because they give the vital signs and provide warning signs when the metrics are unusual.

## Choosing the Right Indicators

While suitable performance measures provide the foundation for informed decision-making, improper ones can distort the conclusions and negatively impact efficiency by disguising critical issues and warning signs. Good metrics have several distinguishing characteristics:

- They are directly related to objectives and strategies.
- They must be understandable but not under-determining.
- They must be meaningful.
- They vary between locations and customer segments.
- They provide fast feedback.

One of the most complete indicators is the percentage of orders delivered in full, on time and error free (DIFOT).

**On-time** Orders received on or before the date requested

---

**In-full** Orders are complete in quantity

---

**Error-free** Orders are complete with proper documentation, labelling, and without damage to items or packaging

---

However, there are a variety of other key indicator examples. Their selection will depend on the specific monitoring needs an organization might have. The following list is non-exhaustive:

- Information available for users (items, lead times, order status, etc.).
- Response time (order acknowledgement, queries, etc.).
- Number of claims and items returned.
- Number of stock-outs.
- Number of back-ordered lines.
- Average backorder time.

## Suggested KPIs For Logistics Monitoring

Total number of Framework/Long Term Agreements.

---

% Of projects with Procurement Plans done.

---

### Supply Chain

Total Number of staff with responsibility to sign a request.

---

Average monthly forecast of logistics expenses.

---

% Of In kind Donation with a donation reference.

---

---

	Monthly total number of Request.
	% Of Requests presented in ad-hoc regular meetings.
	% Of Requests correctly filled and with enough technical specifications.
<b>Procurement</b>	% Of Direct Purchase processes compliant and correctly archived.
	% Of Negotiated Processes compliant and correctly archived.
	Average needed time to process and complete a tender.
	% Of orders fulfilled on time.
	Total monthly expenditure.

---

	% On time delivery.
	% Items damaged in transit.
	% Items lost in transit.
	Average cost per kg/m3.
<b>Transport and Deliveries</b>	Average cost per kilometre.
	Total cargo transported in time frame (kg/m3).
	Average delivery time in days.
	% Of accurate deliveries (sent/received).
	% Of movements without Delivery and Reception Notes.

---



---

Cost per m2 of covered storage space.

---

% Of stock lost due to theft, spoilage or damage.

---

Number of stock outs per month.

---

Average % of floor m2 space used per month / Average m3 used per month.

---

Average time to release stock after pick order received.

---

**Stock**

Number of pest controls per month.

---

Average temperature / Average humidity.

---

Number of temperature alerts.

---

% Of unused stock (out of contingency or more than two years/projects old).

---

% Of products not damaged or not compliant with specification upon receipt at facility.

---

---

	Total number of vehicles
	% Of movement planned in advance
	Total number of driver trainings
	% Of operating hours vehicles are fully booked
	% Of vehicles with the necessary tools
<b>Fleet Management</b>	% Of vehicle logbooks filled correctly
	Total number of maintenances per vehicle in a month
	Average fuel consumption (ltr/km) per vehicle per month
	% Of transport request met vs needed
	% Of vehicles that meet the mechanical and safety standards
	% Of fuel and rental/owned expensed budgeted
	% Of equipment correctly codified and labelled
	Total number of equipment items
<b>Equipment</b>	% Of equipment in use
	Number of old/obsolete/broke equipment dispose following the organization policy
	Average backups done per month
	Total communication cost per month
<b>Information and Communication Technology</b>	% Of movements without coverage during a part of the trip
	% Of computers with official software license

---

**Energy**Total power needed  
\_\_\_\_\_Average hours without power  
\_\_\_\_\_Number of power backup system in place  
\_\_\_\_\_Average power back up maintenance per month  
\_\_\_\_\_Total electricity cost  
\_\_\_\_\_% Of equipment powered with stable voltage  
\_\_\_\_\_% Of installation properly earthed  
\_\_\_\_\_  

---

## Evaluating Logistics Outcomes

Controls are normally put in place to monitor weaknesses, poor designs in projects and improper implementation of programs. Based on the evaluation of outcomes, these weaknesses or shortfalls against targets or objectives set can be corrected or revised in order to continually improve performance.

Each evaluation must be carried out against a pre-established goal that defines not only what is the desired outcome of an intervention, but also the process and needs to achieve it. An evaluation exercise consists of defining the degree of achievement and examining how well or poorly the activities performed have led to those results.

## Logistics Strategy

To ensure planned objectives are accomplished, a logistics unit or team should come up with a strategy that will address challenges and guide the teams towards their goals. Organizations should always seek to optimize use of resources to ensure efficient implementation of activities.

Based on analysis and aligned with the general goals of the project, a logistics team or unit should establish its own ultimate goal or goals that will prioritize operational tasks.

## Objectives and Key Results

Objectives and key results function as a “road map” to guide the teams to a defined goal. Objectives should be formulated as the desired concrete outcomes, expressed as a positive change expected to be achieved after a defined period and in response to identified challenges. The objectives are reached through the combination of the results that are the effects of the activities.

An objective usually has two to three key results for the same reasons that a GPS device needs two to three satellites to accurately pinpoint a location. Each key result is designed to positively impact a certain metric, remove ambiguity by clarifying and quantifying what success for any

given objective looks like, and help measure progress towards that objective.

The composition of a key result looks similar to a KPI, except that a key result includes a timeframe as a starting and target point.

A key result consists of the following components:

- **Identified Metric and Ongoing Value** - Anything the organization measures is a metric and the ongoing value is simply the value that the metric is measuring at any given time.
- **Starting and Target Value** - The results must have a timeframe to demonstrate achievement. The starting value is the original baseline, while the target value is the desired goal at the end of that timeframe.
- **Unit of Measure** - The unit of measure needs to be understandable, and as should what the results itself is trying to achieve. A unit of measure should contain all the components of the key result. For instance, in a key objective to “decrease lead-time from 7 to 5 days” the identified metric is “the lead-time” in days, the start value “7 days,” and the target value “5 days.”

## Action Plan

Results are the outcomes of different activities measured together as a whole that lead to the achievement of an overall objective. On a day-to-day basis, these activities are the most basic steps to focus on. If well designed, performing every activity will lead to achieving a goal.

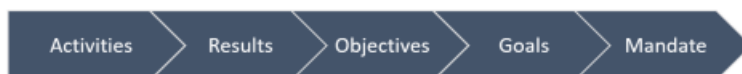

To properly define each of these steps it is necessary to create a clear action plan. An action plan will establish a time frame, indicators, persons responsible, and costs of each activity, and should be shared with all persons involved.

## Logistics Reports

A report is used to analyse facts and information to inform the steps towards reaching an objective and possible problems faced, while an evaluation will take this data and establish the degree of achievement and evaluate how a defined strategy and/or plan have worked.

It is important to create a reporting system that will follow the progress of strategic plans, and give feedback on activities of a specific location over a specific time frame. Reports in general should be as concise as possible whilst ensuring all important information is recorded.

The objectives of a report are:

- To provide supervisors/managers with the necessary information to be able to monitor the activities.
- To keep a record of the history of logistics activities.
- To provide an overview of how logistics activities are arranged in the programme or field location, what the key responsibilities are, and how well operations are managed.
- To clearly identify what the current problems are and what pending activities are yet to be implemented.
- To follow up and keep records on KPIs.

The better the report structure, the easier and more accurate a performance evaluation will be.

## Best Practices

An inherent part of monitoring and evaluation relies on data collection. However, a good collection of data does not guarantee the goals and objectives will be achieved. Frequently collected data is only used to respond to and understand past events, instead of being used to drive future actions. To make the most of the monitoring and evaluation efforts, a proper performance monitoring plan needs to be in place for short-term, mid-term, and long-term activities.

Having a measurement process in place ensures frequent, constructive reviews of defined metrics, and creates a culture of measurement and improvement. Staff should be able to see how their performance affects the achievement of the overall goals.

Tracking the progress of KPIs over a period of time means an organization and its teams have clear visibility on the priorities of the organization or project, and enables team members to easily identify trends, strengths, weaknesses, and opportunities. Having this information at hand gives the planners the opportunity to make better, calculated decisions.

KPIs should be carefully picked by closely reflecting on the organization's strategy and priorities. KPIs transparently communicate what is expected, what should be kept top of mind and how they should carry out their day-to-day activities.

## Monitoring and Evaluation Tools and Resources

### Sites and Resources

[USAID, \(2006\). Monitoring and Evaluation Indicators for Assessing Logistics Systems Performance.](#)

[Davidson, Anne Leslie, \(2006\). Key Performance Indicator in the humanitarian Logistics](#)

## Vehicle and Fleet Management

### Common Terms in Vehicle and Fleet Management

---

**Four Wheel Drive (4WD) vehicle**

Specific type of vehicle able to transfer traction from the engine to the front and rear axis, enabling grip to all four wheels. Also referred as "all terrain" vehicles.

---

**Car**

A four wheel motorised vehicle commonly used for transport of people.

---

---

<b>Discharge of Liability</b>	A <a href="#">printed form signed by passengers</a> not working for the organisation operating the vehicle, discharging the agency of any legal claims in case of accident.
<b>Driver</b>	The person operating a vehicle. He/she must hold a valid driving license specific to the type of vehicle.
<b>Fleet</b>	A set of assets with similar characteristics that are jointly managed. A vehicle fleet is a group of managed vehicles used to achieve a particular operational purpose.
<b>Fuel</b>	Combustible material - normally in liquid form - that when burnt releases the energy required to power the mechanical engine in a vehicle. Petrol and Diesel are the most common fuels used for road motorised vehicles. Jet-A1 is the most common fuel used for air vehicles.
<b>Fuel voucher</b>	A printed form used to access fuel under certain agreement with a particular fuel station. The holder of the fuel voucher will receive a specific amount of fuel on behalf of the organisation in exchange of the voucher. This is a common practice to avoid the management of cash among drivers and to ease the refilling process.
<b>Hard-top vehicle</b>	A vehicle with rigid roof. As opposed to pick-up vehicles, "hard top" is a common term for all 4WD vehicles, except for pickup vehicles.
<b>Light vehicle</b>	A commercial carrier vehicle with a gross vehicle weight of no more than 3.5 metric tons (EU definition); sometimes referred to as light commercial vehicle (LCV),
<b>Mileage</b>	The distance (miles or kilometres) covered by a vehicle for a certain journey. It also refers to the total distance covered by a vehicle since its first use.
<b>Odometer</b>	Counter in the vehicle dashboard to measure distances. Motor vehicles are equipped with at least one odometer to count the mileage since its first use. Additional odometers are available in some vehicles or external devices (such as GPS) to measure trip distance. As opposed to the main vehicle odometer, additional odometers can be paused or reset to 0.
<b>Pickup Vehicle</b>	A light vehicle with an enclosed cabin and an open cargo area, sometimes covered with a soft roof. Generally, pickup vehicles are 4WD.

---

<b>Sedan</b>	A passenger vehicle with separate compartment for passenger and small cargo (trunk). The trunk compartment is normally positioned in the back of the vehicle. They are also commonly referred as “city-cars”.
<b>Fleet Standardisation</b>	The process of reducing the degree of diversity in the managed fleet by homogenising vehicle make, model, major components and/or equipment.
<b>Truck</b>	A motorised vehicle specifically designed for transport of goods and with a gross weight that exceeds 3.5 metric tons. Trucks often require a specific driving license for its operation.
<b>Van</b>	A type of road vehicle used for transporting goods or people in one single compartment.
<b>Vehicle</b>	Any asset operated by a person (driver) with the purpose of transporting goods or people between two different locations. Assets can be motorised or animal-drawn and have from two to more than four wheels.
<b>Vehicle Logbook</b>	A records book for a unique vehicle. A logbook is always kept in the vehicle glove box compartment under the responsibility of the driver assigned to the vehicle. Normally they have two different parts: one to register all repairs and maintenance activities and a second to register mileage and fuel consumption.

## Scope and Definition

Humanitarian action frequently requires vehicle-based mobility work and often demands the management of a fleet of vehicles. Vehicle fleet management refers to the knowledge and practices of managing a set of vehicles to achieve a particular operational purpose. Fleet management allows agencies to minimise risks, reduce costs and improve efficiency related to transportation of goods and people. In addition, it ensures compliance with local legislation and duty of care.

Depending on the organisation, fleet management may include commercial motor vehicles such as cars, vans, trucks, and motorbikes but also air or water transport means such as planes, helicopters, boats, and more. Other sets of assets such as generators, shipping containers, computers or even mobile phones are sometimes also treated as a fleet. The common ground for these sets of assets to be considered as a fleet, includes characteristics such as:

- Managing a considerable number of similar assets.
- Being the set of assets essential for the organisation goals achievement.
- Incurring in significant running costs.
- Facing significant risks if poorly managed.

This section covers only vehicle fleet management, with special focus on motor ground

vehicles. Although the same principles and logic could be applicable to other means of transport or other types of assets, these are not specifically covered here.

Furthermore, fleet management is closely related to “Asset management” and “Road transport”.

Owned vehicles are commonly considered as part of the asset/equipment inventory. Therefore, all management processes affecting assets/equipment should also be applied to vehicles belonging to the organisation’s fleet. This chapter complements asset/equipment management information with specifics related to the motorised vehicles.

It is common for humanitarian agencies manage a fleet of vehicles (cars, vans or motorbikes) to transport people. Agencies specialised in humanitarian logistics may also have to manage a fleet of trucks to regularly transport goods, water or construction materials. This chapter mainly focuses on the management of light vehicle fleets used for the transport of people. For complementary considerations and technical information related to cargo transport, such as cargo configuration, route planning and scheduling or documentation for goods transport, please refer to the [road transport chapter](#).

## Alternatives to Vehicle Fleet Management

In some circumstances managing a fleet of vehicles for the given transport requirements could end up being inefficient, expensive, administratively difficult, or dangerous. Staff movement can be also enabled by combining transportation services from public and private transportation providers.

Humanitarian logistics professionals often validate and contract different transport services that users can access according to their needs. Once a transport services have been identified and enabled, the burden lies in monitoring its use and paying the service providers accordingly. Agreements with the service providers are normally done per trip or/and distance. It is recommended to regularly assess (at least annually) the quality of the service offered by outside transport providers, ensuring its compliance with the contractual terms and its usefulness.

Assessing the operational needs and the context and comparing existing transport alternatives is prerequisite in order to choose the most suitable transport option.

Common alternatives to fleet management are:

<p><b>Other Humanitarian Agencies</b></p>	<p>It is very common for humanitarian agencies to operate simultaneously in certain locations. Pooling resources is a simple manner of optimising costs and recovering an investment. This is valid not only for transportation but also for common fleet facilities or resources, like a mechanical garage, a mechanic or a communications/radio room for movement tracking.</p> <p>For sporadic use of other agencies vehicles, sharing of information and basic coordination mechanisms might be sufficient. In situations where agencies might make regular use of other agency fleet resources, both parties are strongly recommended to formalise partnerships through a Memorandum of Understanding, clearly outlining the benefits of the shared resources and clarifying the terms of accessing it. The contribution of each agency should grant equitable share of management efforts and expenditures.</p>
---	---

---



---

**Collective  
Public  
Transportation**

In some locations collective transportation can result useful and cost-effective for moving people at regional or national level. This method can cover sporadic travels through safe routes not regularly covered by the agency. In addition, public road collective transport companies usually offer the service of transporting small parcels at low rates which can be useful in certain occasions.

Safety of public use vehicles and reliability of the service are major concerns when assessing collective public transportation means, and should be specifically evaluated for each candidate company offering the service. This is especially important in developing countries. Overall condition of the vehicles and availability of the basic safety means, maintenance routines, loading of the vehicle and drivers' capabilities are some of the basic parameters to assess.

---

**Individual  
Public  
Transportation  
(Taxi)**

In urban settings, the use of taxis is one of the most common individual transport means. A taxi's flexibility, affordability and ease of management make of it a very good alternative or complement for the organisation's fleet in urban operations. Taxis can be very useful for managing unplanned requests, and for scaling-up of transport based on need.

Safety and reliability of the taxi service are main concerns and should be specifically evaluated for each candidate company offering the service.

Where taxi companies are not well established or are not reliable, agreements with a specific pool of trustworthy taxi-drivers can be a solution. This is a common practice to cover the transport to and from the airport. This kind of agreements allow extended services such as prolonged stand-by time, wearable visibility from the agency, transport of goods, or handover of necessary material at arrival or departure such as mobile phone or keys.

---

**Third-party  
Transport  
Providers**

Although third-party transport providers are usually specialised in the transport of goods, in some locations they can also be trusted for the transport of people. The transport of people privately operated is mostly handled by renting companies that hire vans, minibuses or coaches with driver. This solution for transporting people is a suitable alternative for punctual and specific needs such as events gathering a significant number of people or for preventative security evacuations.

When regularly using third-party transport providers, a framework agreement can be useful to ease the management process. It is strongly recommended to include particular terms and conditions related to safety in the agreement and to duly assess that they are respected prior to the delivery of each service.

Please reference the road transport section of this guide for more information on the advantages and disadvantages of [using third-party transportation](#), and the [recommended terms for developing contracts](#) for third-party transport.

---

## Fleet Management Process

Vehicle fleet management can be a simple or complex working process depending on the number and diversity of vehicles and the intensity of their use.

## Basic Workflow

Fleet management can be broken down into five basic components:

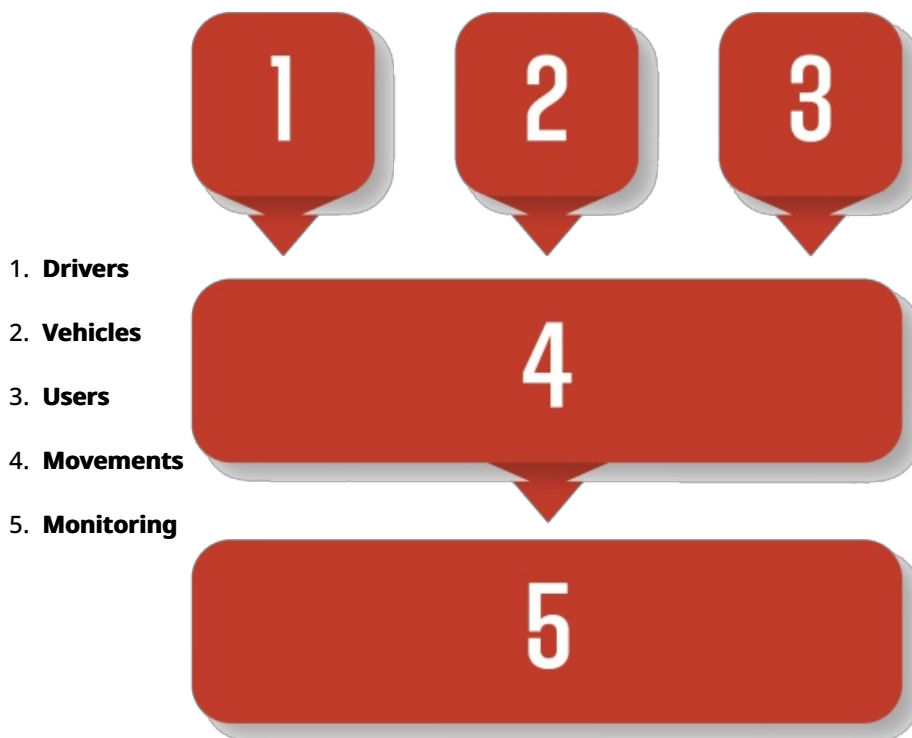

Following this logic, vehicle fleet management can also be looked at as several work streams that are simultaneously executed by one or several people.

1. **Managing Vehicles** - Ensuring vehicles are available and fit for purpose, performing regular checks, maintenance and repairs, administrative clearances, etc.
2. **Managing Drivers** - Ensuring drivers are available and fit for purpose, organising the roster, providing training, sharing relevant information, obtaining medical clearance, etc.
3. **Managing Users** - Ensuring that the users can access the fleet services in a timely and safe manner. This includes understanding user needs and dealing with requests, allocating the pertinent resources, providing the required information for the movement to be duly accomplished and collecting feedback on the service provision.
4. **Managing Movements** - Ensuring that movements are achieved satisfactorily, organising movements according to the needs expressed by users, monitoring of movements to ensure they are performed according to the plan, and ensuring standard working and security procedures.
5. **Monitoring Workflows** - individually and as a whole (fleet) - ensuring due performance, proper balance and adjusting when required. Overuse of resources and mechanical failure, burnout of drivers and bad behaviour, or discontent among the passengers are typical symptoms of fleet dysfunctions that should be addressed.

## Fleet Management Functions

Managing fleet and workflows can help define a typical set of roles and responsibilities for different parties. Combining or dividing tasks between one or several profiles will depend on the scale of the fleet, the intensity of its use and the given operational context. In a field office with a fleet of 1 to 6 vehicles and an outsourced garage, one single person could supervise all workflows and a team of 6 to 8 drivers. If the number of vehicles and drivers is significantly larger or the mechanical garage used to service the vehicles is self-managed by the agency,

new and specialised profiles could be added to the team.

Typical roles and responsibilities in vehicle fleet management might include:

**Driver**

Drivers are in charge of transporting goods and passengers in the organisation's vehicles, ensuring its technical and safety conditions and respecting the country's traffic rules and the organisation's working and security procedures to provide a safe, smooth and efficient service.

To achieve this, he/she should perform the assigned vehicle regular checks, ensure that all vehicle documents and driving licenses are valid and available in the vehicle, refilling the fuel tank when necessary and ensure correct loading and unloading of the vehicle.

In addition, he/she is in charge of informing agency management of any incidents involving the transportation of passengers or goods and should know how to use all types of required equipment, for communication (telephones, satellite phones or radios), safety (first aid kit and fire-extinguisher), recovery of the vehicle and to perform basic repairs and maintenance (changing tires, checking tire pressure, etc.).

---

**Head Driver**

The head driver is a specific profile employed when a significant number of drivers are used in a given fleet. The head driver can sometimes take over many of the duties normally ascribed to a fleet manager, provided the working arrangements make sense. The head driver coordinates the team of drivers, preparing and overseeing their work: regular checks of vehicles, vehicle inventory, refilling, etc. He/she is in charge of reporting any problems with the vehicles as well as ensuring maintenance on the fleet of vehicles and that cars are serviced at the desired time to ensure good use of it and to deliver services.

In addition, the head driver organises training courses for drivers, conducts driving tests for all new drivers and performs regular drivers' assessments.

The head driver can also be in charge of the allocation of vehicles according to the availability of drivers, the preparation of rosters and replacements in case of absence. He/she can be also involved in some monitoring tasks such as monthly reports on services, repairs and fuel consumption of each vehicle.

---

---

<b>Mechanic</b>	<p>A mechanic performs the necessary servicing, maintenance and repair of vehicles (and other engines as generators) to ensure that they are in usable running conditions. He/she also briefs and train the team of drivers regarding vehicle services and maintenance.</p> <p>A mechanic is strongly advised when agencies are running a self-owned mechanical workshop, however mechanics can be employed to also conduct repairs and maintenance on vehicles in a variety of contexts. The mechanic is responsible of the equipment and tools in the garage, checking they are correctly and safely used, maintaining and renewing them when necessary and keeping the inventory updated. Although the mechanic can manage a stock of some basic consumable items, it is not advised that he/she manages the stock of spare parts - this would hinder accountability and goes against the basic division of supply chain responsibilities.</p> <p>The mechanic can also support the evaluation of external workshops for eventual sub-contracting as well as checking light and heavy vehicles before its rental.</p> <p>An intermediary solution commonly used when a full-time mechanic is not required, is combining the role of driver and mechanic, allocating a number of (full) days for mechanic duties.</p>
<b>Mobility/Movement Manager</b>	<p>The movement manager ensures that all movements are organised and implemented. He/she gathers regular and ad-hoc movement requests and assigns available resources accordingly (vehicle, driver and communications equipment when necessary), informing the relevant people about the movement plan and any change on schedules.</p> <p>In addition, he/she monitors and registers any movement, of people, vehicles and cargo, ensuring its implementation under the established working and security procedures: departure, arrival, number of passengers, route taken, standard contact points, etc. He/she should inform of any delay or incident reported by any of the on-route vehicles.</p>
<b>Fleet Manager</b>	<p>The fleet manager is the overall supervisor of the fleet. He/she should elaborate and implement strategies to guarantee the adequacy of the fleet. This includes development and review of the annual plan and budget for maintenance, renewal and scale up when necessary and planning and supervising the human resources to ensure both the sizing and the necessary knowledge and competencies. Depending on the size of the organisation and the vehicle needs, the fleet manager may assume the duties of the movement manager and head driver, or may choose to employ separate distinct job profiles to help manage a wider set of tasks in larger operations.</p> <p>The Fleet manager should monitor the fleet performance and support decision taking with regular reports. He/she should also advise on fleet related topics such as vehicle insurance, type and frequency of maintenance, evaluations of all the hired vehicles and transport companies, drawing up the necessary contracts.</p> <p>In addition, and if applicable, the fleet manager should define the order for spare parts, and assess and identify potential local providers.</p>

---

## Fleet Planning

Fleet planning is a key strategic activity used to shape fleets and their corresponding management model to support adequate and sustainable solutions to organisational needs. Fleet planning encompasses the operational, technical, administrative and financial dimensions of individual organisations, and therefore tends to be very organisational specific.

A fleet plan may depend on donor specific requirements, and may be linked with other organisational policies, such as human resources, daily operations or security policies. Some organisations may require vehicles be restricted to specific projects while others utilise vehicle pools to serve multiple projects. Driving policies can vary from a strict reliance on a dedicated driver from the organisation to using staff to drive the vehicles.

The administrative policies of individual organisations will dictate which fleet management approach will be utilised, and the custodian of the fleet management function is very dependent on organisational policies and structures. In any case, the following elements should be considered:

- The transport needs in a given period:
  - Frequency.
  - Destinations.
  - Passengers.
  - Cargo.
- The context and the available infrastructure:
  - Urban or remote settings.
  - Other transport means available and how secure are they.
  - Condition of roads.
  - Administrative requirements for an agency to own a vehicle and for people to drive it.
  - Basic supplies available like fuel and consumables.
- The costs of running a fleet and the available funding.
- The risks (financial, legal and security related) of owning and/or managing a fleet of vehicles.

The number of vehicles required should be determined in the planning phase. To do so, evaluate the different activities requiring vehicle transport and determine the number of people and the frequency required for each activity. Typical activities to consider, include:

- Field missions.
- Staff transportation:
  - Between offices in the same region.
  - Between accommodation and office or other working sites.
  - Between offices and transport hubs (i.e., airport).
- Support of daily activities such as:
  - Administration.
  - Meetings and coordination.
- Private use of vehicles.
- Cargo movement.

Plans should be developed and resources made available to reallocate, dispose or purchase vehicles in case of scaling up or down, or to renew obsolete vehicles. Additionally, the right number and types of drivers should be evaluated and adjusted to match operations. HR policies such as maximum working hours per day or holidays should be considered. If the

organisation is experiencing significant changes in terms of mobility demand or the operational context significantly changes, a deeper revision of the management model may be required, including:

- Outsourcing some of the fleet related services such as maintenance.
- Type of insurance.
- Recruiting more staff to deal with fleet related workflows.
- Shifting earliest departure time or latest arrival time.
- Incorporating security clearance or convoy procedures for specific movements.

All planning revision should incorporate budget requirements and the strategies to reduce fleet costs. A specific annual budget for fleet activities is strongly recommended including costs of vehicles, maintenance, consumption of fuel and other consumable items.

Costs to consider when making vehicle related decisions include acquisition, importation, fuel, insurance, repairs, maintenance, labour, toll and parking and disposal among others. The investment required for equipment to be installed in the vehicle, such as communications or safety equipment, shouldn't be neglected when budgeting. If organisations do not take all the costs related to owning a fleet of vehicles, it can lead to funding challenges such as insufficient funds to maintain and repair the vehicles, to hire a fleet manager or to organise driver training.

## Vehicle Selection and Acquisition

### Vehicles

The basic considerations in choosing the most suitable passenger vehicle are related with its intended purpose, the number of passengers requiring simultaneous use, and length and frequency of the journeys. Three main options are to be considered at this first stage: motorbike, light vehicle or van/minibus. If transporting cargo, the required cargo capacity should be anticipated. Vehicles with independent trunk or hybrid solutions such as pick-up vehicles can be considered. Visit the [road transport](#) chapter for more information on cargo truck selection. The operating context, environmental and road conditions will affect the decision and determine technical requirements of the vehicle such as 4WD, air conditioning, or other extra features. Availability of spare parts in the local market and local knowledge and capacity to achieve all type of maintenance and repairs is also an important factor to consider.

Other factors that can limit the selecting options can be the available budget, donor's requirements or organisational policies on standardisation of vehicles. Donor regulations can restrict the type or origin of vehicles that they will fund.

### Standardisation

Fleet standardisation can be useful when similar functions are to be achieved by the given set of vehicles. Standardising a fleet consists of reducing fleet vehicle diversity, contributing to significant cost savings and gaining efficiency in key processes such as:

- **Planning** - Costs, assignments, maintenance.
- **Vehicle daily operation** - Regular checks, use of controls and displays, driving "feel".
- **Maintenance and repairs** - Diagnosis, tools, expertise.
- **Inventory management** - Spare parts, fuel, fluids.
- **Procurement and vendor relations** - Market research, contracts, invoices.
- **Monitoring** - Comparing performance among vehicles and drivers, expenditures.

It is important to undertake standardisation not only at vehicle make and model level, but also for vehicle major components and equipment. Purchasing one type of filter, for example, can help track consumption and while enabling fleet managers to negotiate bulk purchases. Improperly managed standardisation can lead to suspicions of collusion: all decisions about standardising the fleet must be done transparently and with high levels of accountability.

## Ownership Modalities

When it comes to vehicle selection and acquisition, ownership modality becomes a relevant debate. Vehicles belonging to a self-managed fleet can be owned, rented or leased.

### Owned Vehicles:

If an organisation decides to acquire its own vehicles, there are a number of areas to be considered. For more information on the advantages and disadvantages of managing self-owned vehicles, please reference the section on [self-owned vehicles](#) in the road transport section of this guide.

### Rented Vehicles:

Rented vehicles have become available almost everywhere in the world. Depending on the context, rentals are offered by private companies or individuals, with or without driver. The reasons to use rented vehicles can be various; financial, programmatic, technical or due to insecurity. Some key factors to consider when renting a vehicle might include:

- The duration of the activities is unknown, and recovering the investment of a vehicle purchase may be difficult.
- The cost of importing a vehicle is too high and there are no vehicles of suitable quality in the country of operation.
- There is an urgent need for increasing the fleet and procuring one or several vehicles will take an unreasonable amount of time.
- There is a sudden increase of demand for transport, such as rapid assessment or new activities.
- There is insufficient work for a full-time vehicle.
- The standard type of vehicle is not suitable for the work, the context, or the environmental conditions.
- Insecure environments where risk of damage or theft is so high that economically it is not worth the risk of purchasing a vehicle.

In all cases some considerations and specific actions must be undertaken before and during a vehicle rental:

- A proper inspection of the vehicle.
- Validation and induction of the rental driver.
- Developing a contract for the service provision.

### Technical and Administrative Inspection of Rented Vehicles

When renting a vehicle it is important to assess its general mechanical and administrative condition. This is done for several purposes:

- Avoiding delays to programmed activities due to vehicle breakdown.
- Enhancing safety of the people involved in the movement.
- Avoiding being blamed of damages already present in the vehicle.

- Ensuring compliance with all national and local regulations.

Ideally all inspections should be performed by a qualified mechanic. It is recommended to use an inspection template that will allow automatic and homogeneous inspection of all vehicles, enabling a reasonable comparison and validation prior to contracting. It is suggested to keep the separate records for each vehicle inspected. An inspection template could cover the following fields:

- Km reading
- Fuel level
- Engine (Noise, leakage, smoke)
- Lubrication System (Leakage, filters, pressure)
- Cooling System (Leakage, radiator, liquid, fan, belt)
- Air admission & injection (Air filter, fuel filter)
- Exhaust System (fixing, leakage)
- Fuel Tank (leakage, pipes)
- Brake System (leaks, noise, pedal, parking brakes)
- Suspension (soft/hard, springs, shock absorbers-bushes)
- Tyres (pressure, tread, state and spare wheel)
- Chassis (Cracks, fastening)
- Body (impacts, bumpers, bonnet)
- Doors (windows, hinges, adjustment, locks)
- Visibility (windshield, mirrors, sun visors)
- Seats (seat belts, fastening)
- Electrical System (battery, starter motor, front and rear lights, Indicators, roof lights, dashboard warning/indicators, wiping system, horn)
- Availability of Jacks & Tools
- Administrative Documents (Registration, Chassis & Engine N°, Vehicle insurance)

A guide for users to mark where physical damages might show on the body:

## Sedan

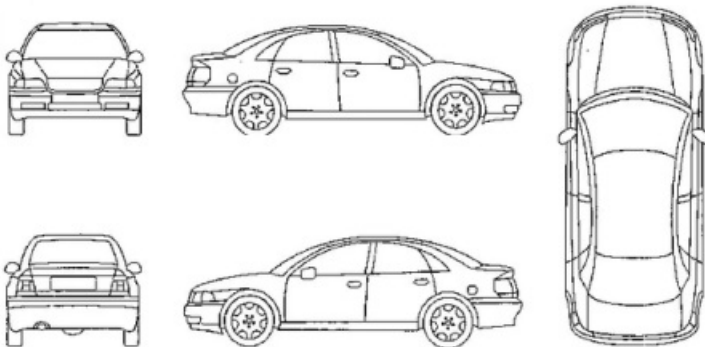



**SUV**

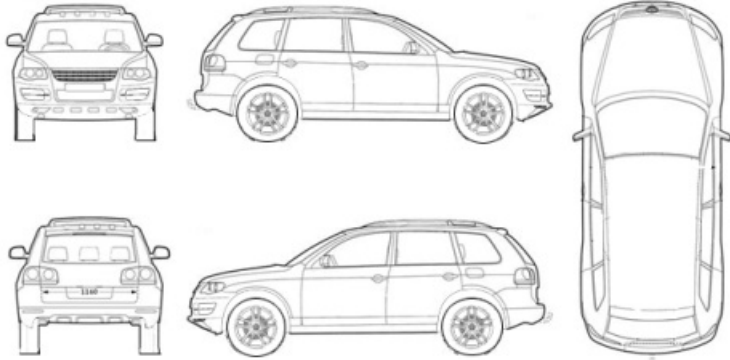

**Van**

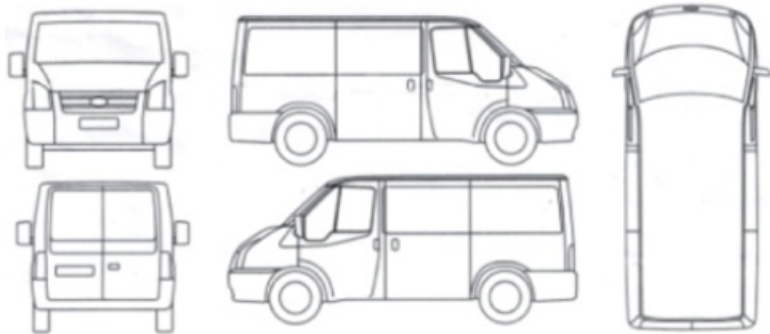

A [template for a daily physical inspection](#) might look like:

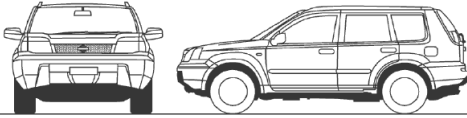
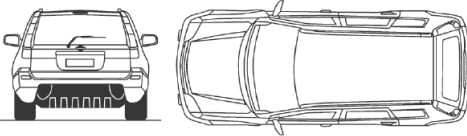
DAILY VEHICLE INSPECTION REPORT				VEHICLE CODE					
INSPECTION		KM		FUEL					
DATE	VEHICLE	CURRENT		MAIN TANK	1/4	1/2	3/4	Full	
NAME		NEXT SERVICE		SECONDARY	1/4	1/2	3/4	Full	
EQUIPMENT		VEHICLE - INTERIOR							
<input type="checkbox"/> FIRST AID KIT <input type="checkbox"/> FIRE EXTINGUISHER <input type="checkbox"/> WARNING TRIANGLES <input type="checkbox"/> SPARE WHEEL AND TYRE <input type="checkbox"/> JACK AND HANDLE <input type="checkbox"/> WHEEL SPANNER		<input type="checkbox"/> REGISTRATION AND INSURANCE PAPERS <input type="checkbox"/> LOG BOOK <input type="checkbox"/> LIGHTS AND SIGNALS *(functioning) <input type="checkbox"/> SEATS AND SEAT BELTS SECURITY <input type="checkbox"/> RADIO - CODAN <input type="checkbox"/> RADIO - VHF							
ENGINE		VEHICLE - OUTSIDE							
<input type="checkbox"/> OIL LEVEL <input type="checkbox"/> COOLANT LEVEL <input type="checkbox"/> BRAKE FLUID LEVEL <input type="checkbox"/> POWER STEERING FLUID <input type="checkbox"/> WINDSHIELD WASHER FLUID <input type="checkbox"/> FAN BELTS AND FAN <input type="checkbox"/> BATTERY AND TERMINALS		<input type="checkbox"/> BODY PANEL CONDITION <input type="checkbox"/> INSURANCE STICKER <input type="checkbox"/> WINDSHIELD AND WINDOWS <input type="checkbox"/> WINDSHIELD WIPER BLADES <input type="checkbox"/> SIDE MIRRORS <input type="checkbox"/> TYRE CONDITION AND PRESSURE <input type="checkbox"/> WHEEL NUT TIGHTNESS							
DAMAGES AND OBSERVATIONS									

*Adapted from IFRC*

It is required to cross-check the vehicle identification (chassis number and engine number) with the administrative documents and the owner identification. Any uncertainty about the ownership or mismatch between the vehicle and the presented documentation should immediately disqualify the vehicle from service.

### Validation and Induction of Rental Drivers

Equally important to the mechanical condition of the rental vehicle are the rental driver's health condition, driving skills, administrative permits, driving and working behaviour and required knowledge to operate the vehicle in the required context, such as speaking local language and the geography that will be travelled. For further information on this matter, refer to the below section on [recruitment: selecting and testing drivers](#).

If rental of vehicles is a long-term strategy, consider keeping a pool of "rental" drivers that can be engaged upon request. Validating and instructing batches of several drivers in a single session will reduce the time spent in this important activity.

### Rental Agreement

In order to draw up a convenient rental agreement, the following should be considered:

- Define the time-frame of the rental and the time unit used for the rate - hour, day, week, month. If the rental exceeds a single day, it is recommended to agree on a daily rate and charge based on days worked. If a monthly rate is used, clarify if calendar month, a period of four weeks or 30 days is covered in the contract.
- Clarify who provides the driver - the humanitarian agency or the owner. If the owner provides the driver, clarify that the driver's cost is included in the rental. In addition, the hours the driver can work must be agreed together with the rate for additional worked hours. If required, the owner should provide a second driver. It is advised that the owner provided drivers come with per diem/accommodation.
- Define the party responsible of providing fuel:

- If the agency provides fuel, make sure that the tank is full prior to its first use.
- If the owner/rental company who provides fuel, ensure that the quantity in the tank is enough to achieve the programmed daily movements, avoiding losing valuable time going to the fuel station.
- Identify the site where the vehicle will be parked at night - the agency's compound or the owners. Where fuel is provided by the agency, the vehicle should be parked in a compound.
- Ensure that there are no restrictions as to where the vehicle can go in any given country. This is especially important on particularly bad roads or in conflict areas.
- Ensure the owner provides insurance and proof of insurance cover. Are passengers already insured or is additional cover required? A comprehensive insurance coverage preferred. The agency should avoid any liability related to car crashes with rental vehicles. Failure to clarify this can lead to dispute and legal demands between vehicle owners and humanitarian agencies.
- Define who is responsible for breakdowns and regular maintenance. It is strongly recommended that responsibility for recovery and repairs falls under the vehicles owner's responsibility: avoid the responsibility for maintenance or repairs on vehicles which are not owned, as the initial condition of the vehicle can lead to frequent breakdowns, abusive practices and enormous levels of investment. If possible, agree on getting the owner to provide a replacement vehicle at no extra charge in the event of a breakdown or maintenance, without causing undue delay to programmed activities.
- Conduct a complete inventory of tools/utensils, keep a record of these items, and ensure the vehicle carries at least the minimum required tools in case of flat tire or minor repair.

*Adapted from MSF Checklist for vehicle rental*

## **Leasing**

In some circumstances leasing could be the most financially advantageous method of renting vehicle for a limited period of time. Vehicle leasing is defined as a long-term rental with certain obligations on the lessor to ensure that the vehicle is properly operating and kept in good condition.

Before deciding to lease a vehicle, the 'whole-life cost' should be calculated and compared to other procurement options. If leasing is the cheapest option, whole-life costing can then be used to identify the optimum lease period and supplier.

The things to consider when purchasing, renting, or outsourcing can be summarised in the following table:

<b>Method</b>	<b>Advantages</b>	<b>Disadvantages</b>
<b>Local Purchase</b>	<ul style="list-style-type: none"> <li>● Lower transport costs.</li> <li>● Fast delivery.</li> <li>● Supports the national economy.</li> </ul>	<ul style="list-style-type: none"> <li>● Might not have the quality or quantity needed.</li> <li>● High demand for vehicles can generate competition among organisations and lead to extremely high prices.</li> <li>● Donors might be reluctant to fund in short term emergency.</li> </ul>

Method	Advantages	Disadvantages
<b>Foreign Purchase/Import</b>	<ul style="list-style-type: none"> <li>• Possible to acquire more vehicles of good quality.</li> <li>• Might lead to lower costs if the organisation has global framework with vehicle manufacturer.</li> </ul>	<ul style="list-style-type: none"> <li>• Longer delivery times.</li> <li>• Higher costs to ship and import vehicles.</li> <li>• Organisations might not be able to import a vehicle into a country, depending on national policy and custom regulations.</li> </ul>
<b>Renting Vehicles (using local rental providers)</b>	<ul style="list-style-type: none"> <li>• Vehicles will only be ordered/used when necessary and can accommodate short trips.</li> <li>• Routine maintenance costs usually are included in rental contracts.</li> <li>• No overhead costs in garage set-up and maintenance.</li> <li>• No high initial purchase costs.</li> <li>• Rental companies might provide insurance and drivers who understand environment and route.</li> </ul>	<ul style="list-style-type: none"> <li>• The organisation loses control over some aspects of its fleet management.</li> <li>• Discontinuation of services can cause disruptions in the day-to-day operations.</li> <li>• If the rental contract is cancelled for any reason, the organisation may have to make heavy investments in vehicle purchase or temporary hire to ensure business continuity.</li> <li>• If rental vehicle comes with a driver the quality of the driver needs to be guaranteed.</li> </ul>
<b>Outsourcing Transport</b>	<ul style="list-style-type: none"> <li>• External provider will take care of everything: drivers, vehicles, fuel, maintenance, insurance, telematics, reporting and more.</li> <li>• Fleet management is not the core activity; organisations can focus strictly on programmatic delivery.</li> <li>• Increases cost savings, human resource productivity and cash flow.</li> <li>• Multiple contract options: per vehicle per journey, per vehicle per day or by the ton.</li> </ul>	<ul style="list-style-type: none"> <li>• The organisation loses control of some aspects of its fleet management.</li> <li>• Realistically, safety, speed and quality must be carefully assessed.</li> <li>• Discontinuation of services will cause disruptions in day-to-day operations.</li> </ul>

Adapted from [Fleet Forum](#)

## Driver Selection and Management

Drivers are an essential component to self-managed fleets, equally as important and the

vehicles themselves. Even if an organisation has a perfectly maintained fleet, poor quality drivers or lack of investment in driver training can lead to accidents, damages, cargo loss and possibly issues with fines or lawsuits.

## **Required Skills and Competences**

Organisations must ensure that all employees involved in driving activities have the necessary competency to drive safely. Competence entails having appropriate knowledge, skills, attitudes, as well as behaviour.

Some of the required skills and competences for drivers are:

- Driving license.
- Respect of humanitarian values and adherence to the humanitarian charter and principles.
- Fitness to drive.
- Ability to apply different driving techniques: defensive driving, off-road driving, eco-driving, etc.
- Literacy in the working language and able to speak the local language.
- Respect and willingness to work with people from different ethnics and origins.
- Experience with specific vehicles to use (4x4, motorbikes, etc.).
- Knowledge of basic mechanics.
- Good knowledge of country roads.
- Knowing what to do in an accident or emergency.
- Willingness for continuous improvement (driving skills deteriorate with time; possession of driving license of itself does not necessarily imply such competence).

Driving for work often entails lone driving without direct supervision from managers or other colleagues for prolonged periods. Drivers may also be required to travel and stay outside a base or find their own accommodation overnight.

## **Recruitment, Testing and Selecting**

Agencies seeking to maintain their own vehicles and have a staff pool of drivers should ensure that the hiring is carried out conscientiously and skills and knowledge are clearly demonstrated. When recruiting drivers, agencies might consider:

- Asking for documentation to prove authorised license to operate the vehicle in question.
- Request a background check.
- Ask the applicant to demonstrate their driving skill first-hand in a safe location.
- Have technical questions prepared in advance.
- If possible, conduct drug screening.

Drivers' competence to drive safely should be assessed at the interview level and/or prior to the allocation of driving tasks. Assessment should take account of the driver's attitude, road safety knowledge and driving skills at the wheel as well other evidence such as age, experience, accident and enforcement history, including penalty points status and past training record. The following can be used as assessment checklist:

## **1. General**

- Years of driving experience.
  - Health issues or regular use of medicines which could affect driving.
  - Conduct a simple eyesight test by having the driver read a license plate number from a distance of 20 meters. When in doubt consult a medical person for a proper eyesight test.
  - Assess knowledge on local driving laws (i.e., maximum speeds in certain location, meaning of particular traffic signal).
  - Ask about previous experience with the type of test vehicle.
  - Familiarity with 4WD controls.
  - Knowledge on basic vehicle service.
  - Good practices to load a vehicle, specifically heavy or hazardous goods.
  - How to react in case of an accident.
  - Use of the Logbook.
-

---

**2. Vehicle and Driving Test**

**2.1) Vehicle check:** Assess knowledge on what should be checked before starting the engine, why this should be checked and what should be done when faults are detected. Checks may include engine fluids; tires; spare wheel, jack and tools; looking for stains under the vehicle.

**2.2) Before Starting Engine:**

- Adjusts the seating and mirrors (yes/no)
- Ensures that seat-belts are fastened (yes/no)
- Is the vehicle out of gear, the clutch lever up and the handbrake on?
- Checks the instrument panel, lights and indicators (yes/no)
- Assess the knowledge on the meaning of the instrument panel lights

**2.3) After Starting Engine:**

- Listens for abnormal noise (yes/no)
- Checks the instrument panel, e.g. oil pressure light (yes/no)

**2.4) Before Driving:**

- Uses of mirrors and indicators (yes/no)
- Shows consideration for other traffic (yes/no)
- Drives off smoothly (yes/no)

**2.5) While Driving:**

- Respects the traffic rules and road signs (yes/no)
- Manoeuvres and control the vehicle correctly (yes/no)
- Uses mirrors and indicators (yes/no)
- Uses gears and controls correctly (yes/no)
- Maintains the right speed considering road condition, load and other traffic (yes/no)
- Drives defensive (i.e., leaving space between vehicles) (yes/no)
- Anticipates hazards (yes/no)
- Shows consideration for other traffic and passengers (yes/no)
- Shows consideration for the vehicle (i.e., no hard breaking) (yes/no)

**2.6) Check Particular Manoeuvres:**

- Emergency stop (Good/Correct/Bad)
- Hill start (Good/Correct/Bad)
- Reversing (Good/Correct/Bad)
- Urban driving (Good/Correct/Bad)
- Lane changing; overtaking (Good/Correct/Bad)
- Off-road driving (Good/Correct/Bad)
- 4W driving (Good/Correct/Bad)

---

**3. Security Awareness**

- Assess knowledge on main driving hazards in the area and measures to mitigate it
  - Handling main present hazards (i.e., checkpoints, car-jacking, crashes, etc.)
  - Behaviour during the assessment (i.e., confident, calm, ability to communicate)
-

---

#### **4. Use of Equipment and Tools**

- High-jack
  - Vehicle recovery tools
  - Communications equipment (radio, sat-phone, etc.)
  - Uses equipment while driving (yes/no)
- 

*Adapted from MSF Drivers Recruitment Test*

### **Non-Professional Drivers (Staff)**

In some circumstances, relying in professional drivers will be unnecessary and other staff will take the responsibility of driving themselves. This may happen when enrolling a driver is not cost-efficient but still there is a need of managing an owned fleet, including when reliable taxi services are not available, specific security risks require it, and more.

On some occasions a mixed solution may be possible, where professional drivers are the only ones allowed to drive during office hours and some categories of staff could be allowed to drive after office hours. Certain restrictions might be established in case of non-professional staff driving, including: distances and time limitations, restrictions people to be transported, limits on leisure usage, or other areas of concern.

In the case were non-professional staff is allowed/requested to drive the agency's vehicles, it is strongly recommended to define a policy framing the access to the service: who has the right to access it and for which purposes, administrative actions to do so, responsibilities from organisation and workers. There should also be basic procedures on sharing vehicles, including: schedules, reservation, keys management, parking instructions, and steps to take in case of incident.

In addition to holding a valid driving permit, the skills of the driver should be duly tested to ensure that he/she has the skills to drive the given vehicle in the given context.

Insurance policies should be reviewed to adapt coverage to the organisation's needs. If necessary, a clear policy on covering repair costs should be established and accepted by the staff.

## **Commissioning**

Commissioning refers to the process of bringing vehicles and users up to the required point of readiness for movements implementation. Commissioning can encompass the following matters:

- Installing required equipment.
- Driver and user briefing and training.
- NGO Visibility/identification.
- Compliance and administrative matters.

## **Required Equipment**

For operating in a given context, additional equipment and vehicle customisation may be required. Typical modifications for harsh road conditions may include:

- Bull bar with mosquito mesh.
- Reinforced front and rear bumper with high-lift jack supports.



- Second spare wheel mounted where safe and appropriate.
- High-lift jack mounted where safe and appropriate.
- Flagpole.

These modifications can be done by vehicle supplier if properly specified during the procurement process. If not, modifications should be performed by a specialised workshop.

For movement tracking purposes and security, reliable communication with the vehicle may be required. This can be addressed by mobile phone with adequate connection, satellite phone, or radio. Depending on the technology and models, certain radio equipment may require specialised installation. The modifications may include: antenna support bracket, grounding wires installed on bonnet, dash mounted installations, and internal wiring and cabling.

For safety purposes, basic equipment may include a fire-extinguisher and a first aid kit.

## **Briefings and Training**

Given the risks incurred while operating in certain environments, a proper induction to both drivers and users should be done. For the new drivers, this can be addressed by the fleet manager or other drivers. For the people making use of the fleet, other profiles in the organisation can be assigned to deliver the briefing. In any case, the time needed to instruct drivers and users shouldn't be neglected.

Topics to be covered for driver's induction may include:

- Driver responsibilities (see the box below).
- Humanitarian principles.
- Communication protocols.
- Reporting procedures in case of accident or break down.
- Internal driving regulation (the organisation's regulation could be more restrictive than the national).
- Movements standard operational procedures.
- Hygiene and infection control.
- Programs and activities.
- Administrative arrangements: how to deal with overtime, contractual arrangements with per diem, etc.
- Use of visibility/identification material such as t-shirts, vests.

## Standard Driver Responsibilities

---

- Ensure safety and security of the persons and goods being transported.
  - Respect traffic rules.
  - Respect speed limits as defined by the agency.
  - Adapt speed according to the conditions of the road, to the carried load, and pedestrian on streets.
  - Wear safety belt at all times and ensure all passengers do the same.
  - Use correct and secure loading for transported goods, and ensuring cargo is tied down.
  - Properly report and notify any mechanical problems.
  - Update daily logbooks.
  - Take care of the tools and spare parts in the car.
  - Ensure cleanliness of the car.
  - Proper notification of accidents, break downs, or other incidents.
- 

---

*Extracted from MSF Logbook*

Topics to be covered for user's briefing may include:

- Journey: schedule, duration and stops in the trip.
- Safety and security: main threats, hot spots and expected behaviour.
- Roles and responsibilities during the movement. Roles of the driver, and assigned movement focal point within the vehicle(s) and at the office level.
- Communications protocol.

### **Visibility/Identification**

Vehicles are a very visible part of the humanitarian operations. When operating in volatile context or in areas with restricted access, clearly displaying the humanitarian nature of the movement may enable access or increase security. For this purpose, specific colours and visibility material such as stickers or flags, can be displayed on the vehicle.

It is recommended that - based on a risk assessment - basic criteria are established for the use

of visibility material. Why, what and when identification material should be used, and where in the vehicle they should be located are among the basic questions to be answered.

Paint, magnetic banners, or stickers are the typical solutions for the body of the vehicle. For obvious reasons, permanent logos shouldn't be the option if there is a risk of car-jacking. When requiring vehicles to carry flags, assess the environment to ensure a proper balance between adequate flag visibility and the impact on other objects such as trees or street furniture.

If requiring intensive use of visibility material in a vehicle, make sure there is enough stock to replace them regularly. If using rental vehicles, ensure that the visibility material is returned once the service is terminated.

## Compliance and Administration

There are certain liabilities related to the use of vehicles that must be considered by any agency managing a fleet of vehicles.

### Drivers

Drivers should have a valid driving license for the specific vehicle they operate. The driving license has an expiry date and should be renewed on a regular basis. Other permits could be required for the transportation of certain categories of goods, such as a commercial license or special permit for transporting some cargo items. Refer to the local/national regulation to learn which are applicable to your activity.

Except for limited bilateral or regional international agreements, national driving licenses are not recognised in foreign countries. For driving in a country where the driving license is not recognised, an international driving license should be obtained. Visit [internationaldrivingpermit.org](http://internationaldrivingpermit.org) to learn about bilateral or regional international agreements on driving permit recognition and how to get an international driving permit.

### Vehicles

Whether the vehicles are owned, hired, or are managed by a third-party, it is important to ensure that all local laws are adhered to. There are different norms that are commonly applicable:

<b>Registration</b>	The use and ownership of motor vehicles are strongly regulated by most countries. All vehicles must be officially allocated to a physical person or organisation who will be liable for any duties or responsibilities linked to the vehicle. It is therefore important to go through the required registration process when acquiring a new vehicle or when decommissioning an old one.
<b>Circulation Permit</b>	Depending on the local regulation, annual license fees may be required for every motor vehicle used on the road. The fee is normally proportional to the gross weight or the engine power of the vehicle, but can be specific to its purpose and type of loads such as oversized or hazardous goods.
<b>Insurance</b>	Insurance is a legal requirement for motor vehicles which aims to provide financial coverage against physical damage or bodily injury resulting from traffic collisions or other incidents. Vehicle insurance may also cover theft, weather or natural disasters and damage sustained by colliding with stationary objects. Vehicles should be insured to at least the minimum level required by the local law. Different organisations will have internal policies regarding the extent to which their own vehicles should be insured. This must be established according to the operational context and a risk assessment.

---

**Technical**

Vehicles may also require a technical clearance certifying that the vehicle is safe for operation in public spaces. Technical clearance may include environmental considerations such as type of fuel used or levels of CO2 emitted by the exhaust. Technical inspections may be related to the type of vehicle and its purpose, certifying the maximum permissible passengers and weights in terms of gross vehicle weight, axle weight and payload.

---

**Fitness to Drive and Medical Clearance**

[Fleet Forum provides the following guidance](#) on medical testing and medical clearances for drivers:

- “ Driving a motor vehicle is a complex task requiring perception, good judgement, responsiveness, and reasonable physical capability. A range of medical conditions, as well as some medical treatments, may impair driving ability. Common examples include blackouts or fainting, sleep disorders, vision problems, diabetes, epilepsy, psychiatric disorders, heart disease, and age-related decline.

It is advised that professional drivers pass a fitness test every year and to install bi-annual checks for staff that drives occasionally. All staff should be advised to undertake a health check whenever they suspect they have a problem. Eye tests should be carried out by qualified optometrists, and should include a test of the driver's horizontal and vertical range of vision.

It's important to ensure that your drivers are mentally and physically fit to drive using a process of self-declaration. Drivers should notify management if they have disabilities or conditions that could prevent them from driving safely.

**Movement Planning and Resource Allocation**

Movement planning and resource allocation are key activities for successful fleet management. The aim of movement planning is to respond to all movement requests while making the most efficient use of resources. Planning must take into consideration elements such as destination, number of passengers, cargo, and match them with available drivers and vehicles ensuring that their condition fits for purpose and is compatible with maintenance schedule.

To ease the planning process and avoid poor resource allocation, inefficiency and discontent among users, a weekly plan is recommended. Transport requests should be completed, approved and delivered to the person in charge of planning movements before an agreed deadline (sufficient time to allow a proper planning).

[Template weekly movement request](#)

Department and/or Office: \_\_\_\_\_ From (date): \_\_\_\_\_ to (date): \_\_\_\_\_

	Monday	Tuesday	Wednesday	Thursday	Friday	Saturday	Sunday
Movement focal point							
N° of passengers							
Destination							
Estimated Time of Departure							
Estimated Time of Return							
Purpose							
Items to carry							
Remarks							

Prepared by: \_\_\_\_\_ Date: \_\_\_\_\_ Approved by (head of department) : \_\_\_\_\_

*Adapted from Action against Hunger Logistics Kit*

Once requests are collected from different departments/services/users, a weekly movement plan can be defined. The fleet manager will organise the movements according to the availability of vehicles, to their capacity (weight, and passenger number) and to road conditions. The following criteria have to be considered:

- Context of the movement and available communications coverage.
- 4x4 or 2x4.
- Experience of the driver under the required conditions. The plan can take several shapes depending on the level or granularity required.

When destinations for several departments coincide, a combined movement can be organised using the same vehicle or moving in convoy. It may happen that there are not enough available vehicles on any given day, so the organisation may have to set priorities and change the program in order to cancel or combine movements or look for an additional vehicle.

The weekly plan can be outlined in different time frames: weekly, daily, or other operationally relevant time frame.

[Template weekly movement plan](#)

**WEEKLY MOVEMENTS PLANNING** From (date): \_\_\_\_\_ to (date): \_\_\_\_\_

*Regular vehicles on the base:*

Vehicle	Driver	Monday		Tuesday		Wednesday		Thursday		Friday	
		Morning	Afternoon	Morning	Afternoon	Morning	Afternoon	Morning	Afternoon	Morning	Afternoon

*Temporary additional vehicles:*

*Adapted from Action against Hunger Logistics Kit*

[Template daily movement plan:](#)

DAILY MOVEMENT SCHEDULE

DATE: \_\_\_\_\_

	Driver	Vehicle	Max. Capacity	06:00	07:00	08:00	09:00	10:00	11:00	12:00	13:00	14:00	15:00	16:00	17:00
1															
2															
3															
4															
5															
6															
7															
8															
9															
10															

For proper planning it is necessary to know all itineraries and road conditions in advance. In unknown areas, a route assessment could be necessary to collect information on distances, timings, intermediary milestones, indications, communication networks coverage, etc. For this purpose, the use of road-books is recommended. [A road-book](#) is a matrix with basic indicators about different legs of a journey between two different locations.

A typical road-book will have the following example outline:

<b>ROAD:</b>	<b>Blantyre - Lilongwe</b>		<b>Duration:</b>	<b>4h 30min</b>	<b>LAST UPDATE: 24/5/2010</b>
			Distance:	305 Km	
<b>LOCATION</b>	<b>CONTIN. TIME</b>	<b>CONTIN. KM</b>	<b>GPS</b>	<b>Comms coverage</b>	<b>Remarks</b>
<b>Blantyre</b>	<b>0:00</b>	<b>0 km</b>			
Round about	0:10	7 km			
Lunzu	0:17	15 km			trading centre
<b>Lirangwe</b>	<b>0:31</b>	<b>31 km</b>			trading centre
Mdeka	0:40	42 km			
Zalewa	0:48	52 km			police station
Cross M1 - M6	0:49	53 km			
Phalula	1:09	81 km			
Senzani	1:20	99 km			
Manjawira	1:25	108 km			
Chingen	1:30	115 km			police station + 1st petrol station
Kampebuza	1:48	137 km			trading centre
	1:58	147 km			Border Ntcheu DC
<b>Ntcheu</b>	<b>2:01</b>	<b>149 km</b>			Capital District - Hospital DC
Tsangano	2:20	158 km			Police station + border Malawi-Moç
Lizulu	2:46	195 km			Trading centre
Bembeki	2:54	207 km			Diversion secondary Rd to Mangochi
<b>Dedza</b>	<b>3:05</b>	<b>219 km</b>			Police station + petrol station
Chimbiya	3:35	243 km			Trading centre
Kampata	3:55	272 km			
<b>Nathenje</b>	<b>4:04</b>	<b>283 km</b>			Customs police
Nanjiri	4:12	292 km			Trading centre
	4:16	295 km			Border Lilongwe DC
Mitundu	4:18	297 km			Police station + petrol station
<b>Lilongwe</b>	<b>4:30</b>	<b>305 km</b>			Town entry

*Extracted from MSF OCBA Logistics Library*

The road-book has indications or milestones based on data points form along the route: distance, time and other relevant information for the journey, such as communications coverage, hospitals, police stations, petrol stations, etc. Road-books can also help for briefing during driver's induction or to determine communication points for movement tracking purposes.

### **Movement Implementation and Monitoring**

Knowing the whereabouts of the vehicles at all moments is essential for a coordinated and reactive fleet, especially when the size of the fleet is large, simultaneous movements take place, and when operations are deployed in volatile contexts.

Different vehicles must have the capability to communicate with organisational offices at any moment, allowing the reporting of any incident or event. Organisational focal points should also have the capability to contact any vehicle at any moment to communicate about changes in plans or the latest contextual updates requiring a change in the route. Having functional communication equipment and a basic communication procedures specifying when to communicate, to whom and with which means is highly advisable for any planned movement.

On some occasions having a specific person to track the movements and record the current location of the vehicle and last contact made is highly advised. When relying on radio communication systems, this role is usually assumed by a designated and trained radio-operator. In locations with sufficient mobile phone coverage and where communications rely on mobile networks, instant messaging applications can be the mean to monitor movements.

Tracking devices are another option to monitor movements. Tracking devices vary in their functionality, but generally they gather information such as vehicle's position, speed, heading and other data using GPS, sensors and other accessories, and sends tracking data via mobile phone or satellite networks to a remote server enabling authorised fleet managers to monitor performance in real time. The information collected is generally used to improve driving patterns, movements plans or fleet performance. In addition, some tracking devices can also send alerts to specific phone numbers when a predefined event happens: high speeds, locations reached, or even crashes. Tracking devices do not substitute communication devices and in all cases, an operational communication device should still accompany the vehicle movement.

## **Fleet Performance Monitoring**

Fleet Management should contribute to the cost efficiency and effectiveness of the organisation while achieving its operational goals. Capturing data, analysing data, and taking informed decisions is a basic three step process to monitor and improve the fleets' performance.

### **Data Collection**

Fleet data should be captured in a structured way, always keeping in mind that collected data should contribute to decision making. Fleet performance criteria can be classified in the following blocks:



<b>Usage</b>	<ul style="list-style-type: none"> <li>• Availability rate: What is the time that the vehicles are available for use (not broken-down or in the workshop).</li> <li>• Utilisation rate: what is the time that the vehicles are used?</li> </ul>
<b>Driving Habits and Condition</b>	<ul style="list-style-type: none"> <li>• Average fuel consumption: is it within the expected range?</li> <li>• Maintenance and repair costs.</li> </ul>
<b>Costs</b>	<ul style="list-style-type: none"> <li>• Fuel costs.</li> <li>• Maintenance and repair costs.</li> <li>• Running costs.</li> <li>• Cost per km.</li> </ul>
<b>Security</b>	<ul style="list-style-type: none"> <li>• Incidents per 100,000 km</li> <li>• Injuries per 100,000 km</li> <li>• Fatalities per 100,000 km</li> </ul>

In order to generate basic indicators, it is recommended that the following information should be collected on a monthly basis:

- Number of working days for the current period.
- Number of days the vehicle was used during the current period.
- Number of days during the current period the vehicle was at the workshop for service or repair.
- Distance covered during the current period.
- Fuel consumed during the current period.
- Costs incurred during the current period for:
  - Fuel.
  - Maintenance.
  - Repair.
  - Tire.
  - Other/Miscellaneous (cleaning, tire pressure check).
- Crashes and vehicle incidents
  - Number of vehicle incidents during the current period.
  - Number of injuries during the current period.
  - Number of fatalities during the current period.

## Vehicle Logbook

Monitoring information is captured at different levels and from different sources. The primary repository of vehicle movement information is the vehicle logbook. The vehicle logbook is a book used to record all the relevant information for a specific vehicle. It is always kept in the vehicle, and is the responsibility of the driver assigned to the vehicle. Normally logbooks have two different parts: one to register all repairs and maintenance activities and a second to register mileage and fuel consumption.

[Template vehicle maintenance logbook:](#)

### Vehicle Maintenance Logbook

Vehicle Number / Plate: \_\_\_\_\_ Date: \_\_\_\_\_

Mini Service "A"	Kilometers	Maintenance detail- Remarks-Work still to be done
<input type="checkbox"/> Clean the engine.		
<input type="checkbox"/> Change the engine oil.		
<input type="checkbox"/> Clean and drain the water separator.		
<input type="checkbox"/> Clean the air cleaner.		
<input type="checkbox"/> Check the oil level: gearbox, transfer box, axles (if water mixed in, change oil).		
<input type="checkbox"/> Clean the axle breathers union and hose.		
<input type="checkbox"/> Grease the transmission (8 nipples) and steering system.		
<input type="checkbox"/> Check the condition of the suspension: insulators (rubber bushes), spring blades and shock absorbers.		
<input type="checkbox"/> Check the condition of the rear and the front engine mountings.		
<input type="checkbox"/> Check the condition of the exhaust pipe and the insulators (rubber mountings).		
<input type="checkbox"/> Check the condition and tension of the belt.		
<input type="checkbox"/> Check the different warning lights of the dashboard.		
		Post a sticker with the mileage of next service on the dashboard.
Next service filter « B » at:		
	Kms	

*Adapted from ACF*

[Template vehicle movement logbook](#)

ORGANIZATION  
LOGO

## VEHICLE MOVEMENT LOGBOOK

Sheet Number:		Month:	Year:		Vehicle No:	Plate:		Refuelling Quantity (Litres)	Remarks (Tolls, fees, etc)
Date	Driver Signature	Departure			Arrival				
		Place	Time	Index (KM)	Place	Time	Index (KM)		

*Adapted from ACF*

Both maintenance and fuel logbook templates are printed in a single book that is filled by driver and mechanic, and collected by the fleet manager regularly. It is recommended to compile all logbooks and process them in a monthly basis.

The information from the Logbook is then transferred to a spreadsheet for consolidation and analysis. Several templates can be used for a systematic collection of data. Fleet Forum offers a [collection and reporting tool](#) based on spread-sheet developed by the WHO.

## Fuel Consumption

The fuel consumption of the vehicle is one of the basic parameters to monitor the vehicle condition and driving habits.

A baseline for vehicle fuel consumption should be provided by the vehicle manufacturer or the fleet manager as per his/her experience. Road conditions, load weight, idling time, use of air conditioned, age of the vehicle, service condition and other things can affect fuel consumption. Taking these factors into consideration, the consumption of a driver-vehicle tandem should be more or less regular in time and significant deviations should be examined to understand the reasons behind and corrected when possible.

Fuel consumption baseline per type of vehicle generally looks like:

Type of vehicle	Fuel Consumption (litres per 100 km)
<i>Sedan &lt; 2.7 tonnes</i>	11.90
<i>PICK-UP / SUV /SUV-4x4 (GVW* &lt;3.5T)</i>	15.35
<i>VAN / MINIBUS (GVW &lt;3.5T)</i>	15.35
<i>ARMOURED VEHICLE (AV)</i>	21.80
<i>BUS / TRUCK (GVW &gt;3.5T)</i>	20.50

*Adapted from WHO*

It is recommended to calculate the consumption after each refill. To make the calculation for a consumption in litre per 100 Km:

1. Record the odometer reading at two different refueling locations (tank should be completely filled).
2. Subtract the odometer reading at the most recent fill-up location from the odometer reading from the previous fill-up location:

$$2,046 - 1,380 = 666 \text{ Km}$$

- Example**
3. Record the quantity of fuel put in the tank at the most recent fill-up location:

80 litres

4. Fuel consumption per 100 Km is expressed as:

$$80/666 \times 100 = 12 \text{ L/100 Km}$$

---

## Other Data Sources

Information on vehicle usage that can assist calculating the availability rate or the utilisation rate could be extracted from the movement planning and workshop records.

Information on vehicle crashes should be also duly recorded to enable monitoring of safety related fleet indicators. Fleet Forum has [developed a comprehensive toolkit for managing crash reporting](#) and analysis.

Collecting regular feedback from the users of the service may provide qualitative information like level of satisfaction, driving practices, driver behaviour and service mindset, safety, and others.

## Vehicle Condition and Maintenance

Good vehicle condition is key in proper fleet management, helping attain operational goals in a safe manner, optimising the use of resources and complying with the national laws and regulations. Good vehicle condition is achieved through appropriate vehicle use and maintenance.

Generally, maintenance can be approached in two different ways:

- **A preventative scheme** consists in scheduling periodic maintenance services.
- **A reactive scheme** consists of waiting for a breakdown to happen before repairing it.

Vehicle fleet management aims to make transport available for the maximum amount of possible time. This is achieved by planning maintenance interventions and limiting the downtime to a minimum.

It is always bad to lose the use of a vehicle for a day. But when vehicle maintenance is

scheduled in advance, teams or staff can plan around the absence to reduce impact with other activities requiring the use of the vehicle.

Furthermore, running a vehicle without preventive maintenance results in inefficiencies because the subsequent breakdowns tend to cost significantly more and the repairs take much longer to complete. Certain breakdowns can affect the vehicle reliability and consequently the user's safety. Repairs and maintenance should be timely done without delay to keep the vehicle in a trustworthy state during its whole life cycle.

## Frequency of Preventative Maintenance

Preventative maintenance starts with daily and weekly checks. These inspections are the responsibility of the driver with the goal of proactively identify possible mechanical issues. A recommended preventative maintenance schedule is listed below:

*Before starting the vehicle engine for first use in the day, the driver should take 10 minutes to check:*

- *Engine oil level.*
- *Coolant level.*
- *Brake and clutch fluid level.*
- *Windscreen washer water level.*
- *Cleanness of radiator.*
- *Condition of all tyres, including the spare tyre (pressure by sight, cracks on both sides).*
- *Possible leaks under the car.*

*After starting the vehicle, the driver should listen for abnormal noises, check indicators, lighting and dashboard warning lights, and look for the presence of all required equipment.*

### **Template Checklist**

*Once per week (recommended at the end of the week), the driver should take 1 hour to:*

- *Clean the vehicle inside and outside.*
- *Clean the air filter.*
- *Check the battery (proper fixation and water level).*
- *Check power steering oil level.*
- *Check steering wheel free play.*
- *Check tyre pressure and condition of the tyres (see tyre pressure table).*
- *Check for presence of valve caps.*
- *Check and clean front and rear axle breather.*
- *Check exhaust pipe and silencer condition and fixation.*
- *Check the springs and all bushes from the front and rear suspension.*
- *Check shock absorbers (check bushes and no leaks).*
- *Check front and rear stabiliser bar bushes control.*
- *Check functioning of doors, locks, seat belts and (warning) lights.*

---

*Adapted from MSF Vehicle maintenance logbook.*

In case of any identified problems, the driver should record them in the vehicle logbook and inform the fleet manager, who will evaluate the scale of the damage and to plan all relevant arrangements.

Besides the regular checks under the driver's responsibility, specific maintenance services are regularly required to keep the vehicle up to a good functioning standard. Different parts or fluids in the vehicle require different frequency for its replacement: for instance, engine oil requires changing with a higher frequency than the axles oil. Other interventions, like

changing brakes pads or replacing the tyres will be done according to the part's current condition.

Fleet managers should check with the vehicle manufacturer about what regular maintenance is required for the vehicle and the recommended frequency for repairs and maintenance. The maintenance schedule is usually available in the vehicle manual, but is usually also available online. The frequency of maintenance should be adapted according to the conditions of use specific to every operational environment, and periodic maintenance should be conducted of a qualified mechanic.

## **Owned or Subcontracted Mechanical Workshop**

In general, the choice between setting up and managing a workshop or using a mechanic services provider is based on:

- The size of the fleet and the scope of maintenance requirements, based on what is needed, for how many vehicles, and how often and what tasks need to be performed.
- The availability and quality of available service providers and spare parts.
- The cost of every alternative solution.

Organisations should consider all factors before settling on possible alternatives.

A mixed solution where the basic services are performed in a self-managed workshop and more complex interventions are outsourced is often a suitable solution when operating in remote locations where services and infrastructure are limited and the distance to the closest mechanic workshop makes frequent use impractical.

Although evaluating the "availability" could be the easiest part, assessing the quality of service can be difficult. Some of the following things could be used to assess service providers:

- Deviations from initial diagnosis, repair costs estimate and time.
- References from other clients.
- Number of ad-hoc repairs attributable to lack of maintenance, or were required despite of making the recommended regular maintenance service.
- Recurrent faults in a particular vehicle. If a vehicle is brought to service with specific issues, these should be solved (preferably "permanently") when the service is done.
- Number of vehicles reaching their estimated lifespans. All vehicles following the recommended regular maintenance should be in reliable running condition until their normal lifespan.

In addition, some basics could be assessed in a visit to the workshop premises:

- Safety and security, with special attention to access control.
- Availability of specific suitable tools in good condition and their safe use: tyre assembly, welding, power equipment, grinding wheel, etc.
- Availability of specific premises and capacity to work on simultaneous lanes for light vehicles, trucks, motorbikes, generators.
- Type of mechanical interventions possible: Engine, body, paint, electrical, vehicle computer programming.
- Availability, sourcing, and control over spare parts.
- Cleanliness and general condition of the workshop.
- Working conditions and care for occupational risks.
- Procedures with used parts and general and hazardous waste management.

Costs should never be the guiding principle- quality of service is paramount. Running costs,

especially the initial investment for an owned workshop, can be considerable. The time period covered by any self-managed workshop is of key importance as the time to recover the investment can be significant.

If the final decision is to outsource maintenance, it is important to carry periodic assessments of the quality of service and to keep records of all repairs and maintenance. It is recommended for the assigned driver to be present during the whole repair process and avoid overnight stays for vehicles if the premises are not considered secure. It is recommended to request a visual inspection of all the parts that have been replaced and invoiced.

## **Refuelling**

Fuel is essential for vehicle functioning and is a significant expenditure in most humanitarian operations. Poor quality fuel can cause serious (sometimes irreversible) mechanical problems and considerably reduces the vehicle's lifetime. Therefore, fuel refilling is a basic activity but must be carefully controlled.

An average light vehicle consuming 10L of fuel every 100 Km, travelling 100Km daily will have to refill at least once weekly (more or less often depending on fuel tank capacity). Basic rules for fuel use:

- Always drive with more than half of the tank full, to avoid an "almost empty tank" situation in the middle of a journey.
- Always refill out of service hours, to avoid affecting regular activities.

It is recommended to schedule at least 1 refill per week, regardless of the tank level of the vehicle. Refills should be done up to full tank capacity. This will ease fuel consumption calculations and reduce the frequency of refills. Fuel refilling can be a hazardous and time-consuming activity, especially when managing large fleets or in congested gas stations.

It is suggested to incorporate a fuel refilling procedure within the fleet management policies. In addition to the above-mentioned issues, procedures should include basics on fuel quality and payment methods.

Fuel should be protected against all accidental or intentional contamination - no impurities, dust, other liquids, or chemical additions should interact with or mix with fuel. Fuel quality should be checked throughout the supply chain, especially if transported or stored in barrels, as barrels may be dirty or water from humid air condensation.

Managers must ensure that vehicles are refilled with the correct fuel type: filling up a diesel vehicle with petrol has irreversible consequences and can end up destroying the engine.

## **Use of Outside Fuelling**

If regular refilling is done by vehicles directly at an outside fuel station a refilling procedure should be defined and include the following basic topics:

- Which fuel stations are valid for refilling: a regular procurement procedure should be applied to select the most appropriate fuel supplier. Basic criteria such as: price, fuel quality, proximity, reliability, payment conditions, other available services (tire pressure check, cleaning) should be included in the evaluation.
- The persons authorised to acquire fuel
- The maximum quantity that can be drawn.
- The payment method. Vouchers or post-paid cards are suitable options. Cash should be avoided due to the risks and the administrative burden, especially with large fleets and

multiple drivers. For the use of vouchers and post-paid cards an agreement must be reached with the supplier specifying the terms of use.

[Template fuel voucher:](#)

<b>FUEL VOUCHER</b>		N°: _____
<i>To be used only for the purchase of fuel when not paid on delivery.</i>		
<b>Fuel station name:</b>	<input type="checkbox"/> For a vehicle <input type="checkbox"/> For stock	ID: _____
AUTHORISATION		
Type of fuel to be delivered: <input type="checkbox"/> Diesel <input type="checkbox"/> Gasoline <input type="checkbox"/> Kerosene		
To deliver in the vehicle tanks(s): <input type="checkbox"/> Full tank(s) <input type="checkbox"/> Specified quantity: _____ liters	Other: <input type="checkbox"/> Jerrycan(s) _____ liters <input type="checkbox"/> Drum(s) or cistern(s) _____ liters	
Authorized by (name and signature):		Date: _____
FUEL DELIVERED		
<b>Quantity delivered in figures:</b> _____ liters      Date of delivery: _____ <b>in letters</b> _____ liters		
Received by (employee name and signature):	Signature of the station manager and stamp:	
<b>When the fuel is for the vehicle, do not forget to fill the fuel logbook.</b>		

*Adapted from ACF*

To allow reconciliation and payment, the voucher should be printed/filled with carbon copy in three sheets:

1. Responsible for authorisation.
2. Fuel station.
3. The employee receiving the fuel for subsequent delivery at office for reconciliation and payment purposes.

For an overview of self-managed fuel supplies, please review the section on [stocking and managing fuel](#) at the end of this guide.

## End of Vehicle Life



Managing the entire vehicle life-cycle of vehicles is essential to achieve an efficient use of resources, including the eventual decommissioning or disposal of vehicles. It is preferable to sell and/or replace vehicles before they become too expensive to maintain, and so ensure that their optimal resale or replacement value can be achieved.

Benefits of properly decommissioning, disposing and replacing vehicles, include:

- Contributing to lower maintenance costs.
- Lower CO2
- Optimising the selling price of the vehicle.

## Economic Life

“Economic life” is the expected period of time during which an asset remains useful to the average owner. When an asset is no longer useful to its owner, it is considered past its economic life. The economic life of the vehicle should be defined by each agency as part of its asset management policy: some may consider 48 months, some other consider 60 months.

The example below shows a linear estimation over time of the value of a vehicle procured valued at USD \$20,000, considering 48 months of economic life.

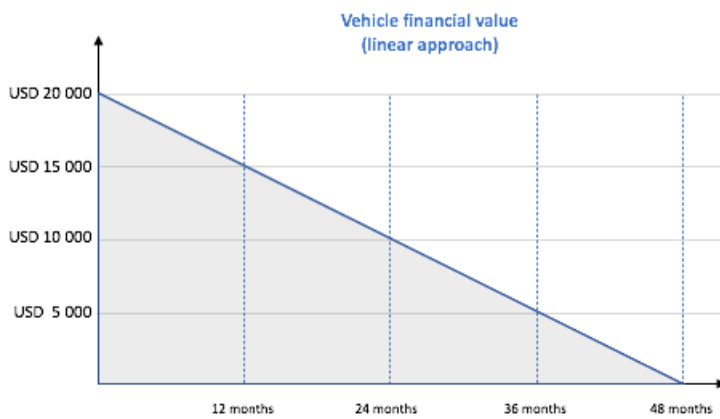

More complex models can be applied to represent the vehicle value over time. As an example, a curved exponential approach may be more accurate for certain purposes, as the vehicle loses much of its value after its first usage. Economic life can be calculated by determining the point at which the estimated resale value of a vehicle becomes lower than the annual operating costs.

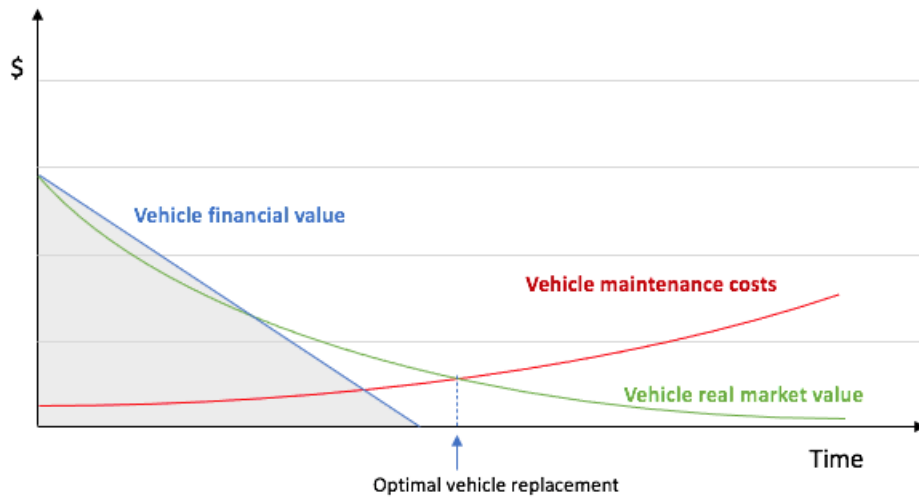

Due to the nature and cost of many vehicles owned and operated by humanitarian agencies, many organisations may choose to sell a vehicle well before the maintenance cost reach the same level as the repair costs. This holds especially true for operations in which the risk of an inopportune break down is more than just the cost of repair. This might include:

- The real safety of the vehicle may diminish if agencies operate in insecure environments that require emergency vehicles at all times.
- Rugged or off-road terrain that requires consistent performance from vehicles.

Below is an example of the changing resale costs vs maintenance costs compared to the original purchase value:

Year	Original Purchase Cost	Estimated Resale Value	Annual Cost of Maintenance and Fuel
1	\$50,000.00	\$45,000.00	\$5,000.00
2	\$50,000.00	\$40,000.00	\$5,500.00
3	\$50,000.00	\$38,000.00	\$6,000.00
4	\$50,000.00	\$35,000.00	\$6,500.00

<b>Year</b>	<b>Original Purchase Cost</b>	<b>Estimated Resale Value</b>	<b>Annual Cost of Maintenance and Fuel</b>
<b>5</b>	\$50,000.00	\$32,000.00	\$7,000.00
<b>6</b>	\$50,000.00	\$29,000.00	\$7,500.00
<b>7</b>	\$50,000.00	\$25,000.00	\$8,000.00
<b>8</b>	\$50,000.00	\$22,000.00	\$8,500.00
<b>9</b>	\$50,000.00	\$19,000.00	\$9,000.00
<b>10</b>	\$50,000.00	\$16,000.00	\$9,500.00

Agencies should always keep in mind that the economic life of an asset is different than its actual physical life. Vehicles will usually always live longer than their respective economic lives to an agency, and the relationship between the two will depend on the utilisation of the vehicle and the operational conditions. In this sense, it is common to set a limit in mileage to start considering replacing a vehicle - 200,000 Km (+/- 50 000 Km) is often used as a basic rule.

Some agencies may decide to extend the life of a vehicle beyond its economic life. This is especially pertinent when a good maintenance scheme has been applied and records show that the costs of maintaining the vehicle is still below its market resale value. The decision of replacing a vehicle should be sustained by consistent fleet management records reflecting costs, utilisation, safety, and asset age.

Furthermore, depending on the country legislation related to the humanitarian agencies and the funding mechanisms used to purchase the vehicle, some limitations to this logic may be applicable. Some countries don't allow private NGOs to resell assets like vehicles and some donors require the donation or transfer of vehicles at the end of the project to another funded agency or project. Being aware of country legislation and donor's specific procedures related to assets and vehicle management is of key importance to avoid incurring significant legal or financial risks.

## Decommission and Disposal

Once the decision for vehicle replacement is taken, different options for old vehicle decommissioning and disposal should be considered. The most common disposal methods are:

- **Donation** - vehicles in good condition and meeting safety requirements may be subject to donation to partner agencies or key stakeholders. Donations must follow national legislation and internal policies and need to be properly documented.
- **Sale** - vehicles that are not needed and have a viable market value may be subject to resale. To avoid any suspicions on favouring particular entities or people, a fully documented auction is recommended. Resale of a vehicle must follow national legislation and internal policies and need to be properly documented.
- **Transfer** - vehicles in good condition and meeting safety requirements may be subject to transfer to another entity or programme. This is the preferred option by most donors when the vehicle remains within its economic life. Also, it is a convenient solution when closing projects or dismantling local offices with vehicles assigned.
- **Destroy or harvest for spare parts** - vehicles in poor condition or not meeting safety requirements should be destroyed or dismantled to recover usable parts. A public or private institution with capacity to properly perform the task should be identified. Environmental risks assessment needs to be performed and a certificate of destruction may be required by the authorities to update the vehicle registry and to formalise the vehicle withdrawn from circulation. Notifying authorities may be especially important to avoid further tax charges or liabilities.

As part of the decommissioning process, agencies should remember to recover and reassign all the vehicle equipment that could be reused, including communications equipment, safety material, recovery kits, identification/visibility, and more. Agencies should also remember to inform authorities and insurance companies once vehicles are no longer in use.

## Safety and Security

### Duty of Care

Whether vehicles are owned or rented, it is essential to ensure that movements are carried out safely, both for the occupants of the vehicle and for other users of the road. It should be noted that road traffic injuries are the leading cause of death globally among people between the ages of 5 and 29. Furthermore, of the total number of deaths from traffic accidents worldwide (1.35 million per year), [90% occurs in low and middle-income countries](#).

[According to Aid Worker Security Report 2020](#) the most dangerous place for aid workers in general remains the while in a vehicle on the road, especially where law enforcement may be relaxed, and where armed groups and criminal elements can easily set up illegitimate checkpoints, roadblocks or improvised explosive devices (IEDs), or carry out armed ambushes on humanitarian actors and convoys. Although security management often falls under the responsibility of other persons with an aid agency, it is encouraged to exchange regular information and to integrate as much as possible safety and security procedures into fleet management working processes.

### Basic Minimum Standards

To ensure that movements are carried out safely, logistics must actively work on three key elements:

- Movement planning.
- Vehicle safety.
- Driver and team's competence.

Though, in the first instance, organisations should seek to control risk on the road by reducing or eliminating the need to travel.

1. Regarding Movement planning, it is recommended to make an "in-depth" analysis of threats and vulnerabilities linked to vehicle movements, plan movements accordingly and create adequate travel protocols as per context and movement type. Additionally, an integral system for movement tracking and follow-up adapted to the context should be implemented.
2. Vehicle safety includes the good mechanical condition of all parts of the vehicle in motion, and to the extent possible, avoiding accidents; braking, steering, suspension, adherence to the ground (tires) and lights. Vehicle safety also includes elements that minimise the damage that can occur when the accident occurs: airbags, functioning seat belts, headrests, and windows/bodywork.
3. The driver and team's competence encompasses: personal skills, physical condition, knowledge of the environment and awareness of potential hazards and the ability to properly manage possible critical situations: such as weather events, accidents, check-points, demonstrations, harassment.

## Vehicle Accidents

Agencies are strongly advised to design and implement an internal management system for vehicle accidents. The system should include: reporting mechanisms, basics on crash management, and analysis and reporting on road crashes. When possible and available, all tools should be coordinated together with security managers.

Reporting a road traffic crash, or a potentially unsafe situation such as a near miss is the first step to reducing future crashes. Anytime a vehicle is involved an accident, near miss or other incident, an accident/incident report form should be filled out, detailing all information pertaining to the accident. If operating in an area with functioning police, a police report should be filled out if required, and all information on witness and other vehicles should be capture. A report should only be filled out after the vehicle and persons are safe and free from additional danger, and after all injuries have been attended to. It is recommended that blank copies of [accident/incident report forms accompany each vehicle](#). Fleet Forum offers a comprehensive crash data analysis tool, including actions to take at a crash scene, capturing information at-the-scene and driver post-crash report, insurance claims, and basics on logging and recording information about a crash.

Policies relating to how drivers/passengers should respond to a crash vary from agency to agency. As a general guide:

- Drivers nor passengers should ever admit fault at any location other than safely back at the office/compound with a security officer present. If a driver or vehicle is at fault, it should be settled by insurance.
- National regulations may require a vehicle to come to a full stop and wait for a police report before a vehicle can move after an accident. The need to stop should be context specific, however - if the area is unsafe, large crowds are gathering, or local law doesn't require it, vehicle may choose to move to a safer location.
- Payments and negotiations for damages should never occur on the scene, nor should they be undertaken by the driver or occupants. All exchange of money and negotiations

should occur in a safe location, and between authorised persons following the regulations of the law and respective insurance companies.

## Special Movements

Special movements vehicle movements that require special planning and organisation.

Typical special movements might be:

- Movements with heavy planning requirements.
  - Exploratory missions into unknown areas.
  - Convoy travels.
- Movements of special items.
  - Transport of dangerous goods.
  - Transport of valuable assets.
  - Transport of special passengers (patients, kids, human remains).
- Movements of special vehicle types.
  - Ambulance services.
  - Armoured vehicles.

Usually, two or more of the above listed movements are combined. For instance, an organisation may plan a convoy because of the inherent value of the transported assets.

Basic considerations for any special movements are:

### **Movements in Unknown Areas**

- Organise the planned movement well in advance.
  - Minimise the number of passengers.
  - Define the roles and responsibilities among the team members. Ensure that at least one driver plus a passenger are in each vehicle.
  - Communicate with relevant stakeholders in the area and assess their capacity to deliver assistance in case of need. Inform them about the journey schedule and itinerary.
  - Assistance may be unavailable: bring vehicle recovery kit. A second vehicle is highly recommended in order to provide assistance in case of severe breakdown.
  - Resources could be scarce: bring food and water.
  - Depending on the duration of the journey and if overnights are possible, consider bringing additional fuel and the appropriate number of sleeping sets.
  - Assess communication networks in the areas of the planned movement
  - Bring several communication devices using different technologies.
  - Ensure one person is monitoring the movement and recording all milestones through the planned journey. Allocate a back-up for this person.
-

---

**Convoy  
Movements**

- Define positioning within the convoy, especially the first and the last car in the convoy.
- Define the distance between convoy elements.
- Allocate sufficient time for preparation before departure.
- Agree on basic procedures to be applicable by the vehicles to ensure certain discipline within the convoy: departure, stop-over and contingency plans for common scenarios: vehicle breakdown, accident, checkpoints, etc.
- Define which are the communication means internally and external to the convoy. Agree on the hierarchies.
- Compile a vehicles list, drivers list, passengers list and any other list that could be useful during the journey.

---

**Movement of  
Dangerous Goods**

- [Refer to the LOG Chapter on Dangerous Goods](#)

---

**Transport of  
Temperature-  
Controlled Medical  
Items**

- [Refer to the LOG Chapter on Managing Health Supply Chain](#)

---

**Transport of  
Valuable Assets**

- Be discrete. Don't disclose the nature of the movement.
- Inform the occupants of the vehicle about the nature of the movement, but not in advance. Give them the chance to decline the assignment and remain at departure point if not comfortable.
- Avoid regularly scheduled movements, schedule for different days and different hours.
- Consider organising as part of a convoy.
- Reduce the number of stopovers to those strictly necessary.

---

**Transport of  
Special Passengers  
(patients, kids,  
human remains,  
etc.)**

- Ensure that the vehicle is fit for purpose and has the necessary equipment to transport the specific passengers.
  - Have clear rules on who is allowed to travel and in which conditions: who authorises the passenger, how much luggage is allowed, safety considerations, point(s) of destination, etc.
  - Brief passengers about the movement: schedule, itinerary, stopovers, etc. Consider including information about the return trip.
  - If minors are transported, they should be always accompanied by an adult.
-

---

### **Ambulance Services**

- Ensure that the vehicle is fit for purpose and has the necessary equipment and medical supplies to transport patients.
- Children patients should always be accompanied by an adult.
- One medical staff should be present during the transfer in case medical needs are required.
- Provide basic PPE and Infection Control SOPs and training to the staff working in the ambulance to avoid cross infection from transported patients.
- If the patient is seriously ill, inform the receiving medical facility in advance that the patient being transferred.
- If providing oxygen to the patient, for safety purposes, oxygen concentrators are a preferred option rather than Oxygen cylinders.

---

### **Armoured Vehicles (AVs)**

- Ensure that the vehicle is fit for purpose and is armoured according to the threats present in the area of operation: armoured steel floor, armoured rear cargo area, etc.
- Technical specifications should be provided by a subject matter expert.
- Consider import and export restrictions, and any laws regarding use of the vehicle around the planned area of movement.
- Ensure that drivers have gone through specific training programs and certification required for AVs.
- The costs of managing a fleet of AV increases significantly compared with a fleet of regular vehicles.
- Maintenance of AVs requires specialised knowledge and capacity as vehicle configuration differs from regular vehicles, especially the electronic components. Spare parts are often manufacturer specific, and can be very hard to come by.
- All communication equipment must be operable from the inside, which may impact some communications devices such as regular mobile phones. Additional communication equipment and specific installation and setup will be required.
- Disposal at end of life is not easy and should be planned far in advance.

---

## **Other Logistics Considerations**

In addition to vehicle fleet management, other aspects may be considered when managing a fleet of vehicles. The most pertinent could be the management of special stocks and the environmental impact of the fleet. When managing a fleet of vehicles, it may be useful to stock particular commodities such as fuel and spare parts. The information in this section is complementary to the chapters on sections on [physical stock management](#) and on [dangerous goods](#). Rather than focusing in safety issues, the content below is more related to the good conditioning and management of stocks for optimal use:

### **Self-Managing Fuel**

Humanitarian organisations considering managing their own fuel stocks should review the [Managing Fuel section](#) of this guide.

### **Managing Spare Parts**

It is important to know when to self-manage a stock of spare parts. The decision is usually



linked to the convenience of a self-managed workshop and to the use of owned and standardised fleet of vehicles. Given the complexity, it is not recommended to hold a stock of spare parts if the variety of vehicles in the fleet exceeds two or three different models.

Managing a fleet of self-owned vehicles in contexts where a supply chain remains uncertain imposes a high degree of autonomy in terms of spare parts availability. The risks of not having spares at the wrong moment must be assessed. The following matrix can be adapted and used as guidance for decision taking.

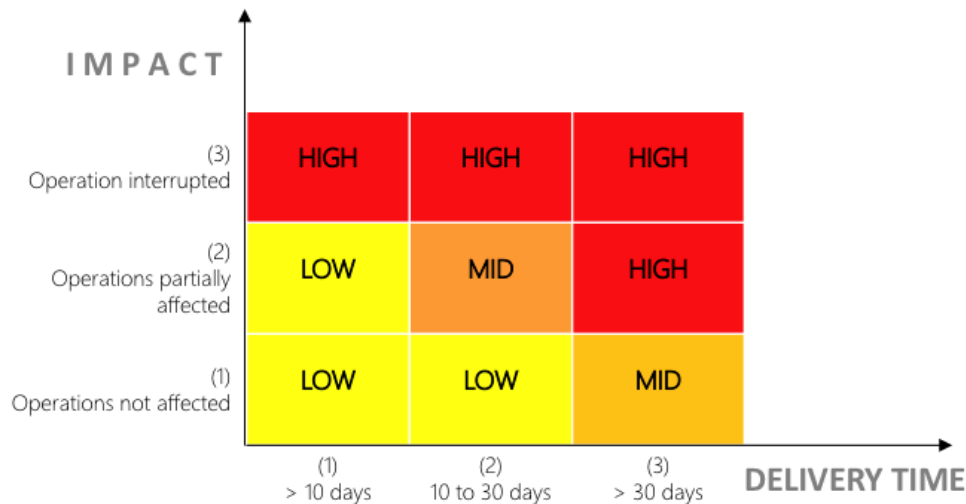

Also consider the reliability of local markets: the cost of original parts purchased locally can be double or even triple that of buying internationally. Generally, most of the parts available locally consist of high demand parts such as filters or brake linings, while less demanded parts may be less available but just as important. Some consumables - such as lubricants and tires - can be easily found locally.

It is recommended to perform market research with a comprehensive list of parts and carefully assess the quality of available parts and validate suppliers. Original quality supplies should be always demanded as the consequences of using counterfeit or substandard parts can seriously affect the condition of the vehicle and jeopardise rider safety.

Once organisations decide to hold a stock of spare parts, they should define the type and quantities of each part required. This can be calculated based on the scale of the fleet, the frequency and types of the preventative maintenance services and the average number of kilometres completed per month per vehicle.

## Managing Environmental Impact

Logistics teams must guarantee an efficient use of resources, optimising costs and reducing the environmental impact of movements.

Movement planners should look for opportunities to combine, or in some cases avoid travel. Fleet managers should try to reduce the size of the fleet or replace vehicles with smaller, cheaper and more efficient ones wherever possible. Pooling logistics resources, such as vehicles, with other organisations may also provide significant cost and emissions cutbacks through optimised fuel consumption and smaller fleets.

A vehicle's good mechanical condition and proper use will reduce fuel consumption, extend the life of all vehicle parts, avoid unnecessary expenses, and ultimately, reduce environmental

impact.

## Vehicle and Fleet Tools and Resources

### Templates and Tools

[TEMPLATE - Accident Incident Report Form](#)

[TEMPLATE - Daily Cargo Vehicle Checklist](#)

[TEMPLATE - Daily Movement Plan](#)

[TEMPLATE - Discharge of Liability](#)

[TEMPLATE - Fuel Consumption Log](#)

[TEMPLATE - Fuel Voucher - External](#)

[TEMPLATE - Fuel Voucher - Internal](#)

[TEMPLATE - Maintenance Request](#)

[TEMPLATE - Movement Request Form](#)

[TEMPLATE - Vehicle Daily Inspection Report](#)

[TEMPLATE - Vehicle Maintenance Logbook](#)

[TEMPLATE - Vehicle Movement Logbook](#)

[TEMPLATE - Weekly Movement Plan](#)

[Guide - Vehicle Servicing - Motorcycle](#)

[Guide - Vehicle Servicing](#)

### Sites and Resources

- [UNECE Road Safety Special Envoy](#)
- [WHO Road Safety Strategies](#)
- [WHO: "Save Lives" A Road Safety Technical Package](#)
- [FIA Foundation](#)
- [Fleet Forum Occupational Road & Fleet Safety Guide](#)

### Electrical Power Generation

In general, energy can be defined as anything that has "the potential for causing changes". The most common definition of energy is the work that a certain force (gravitational, electromagnetic) can do. Energy is conserved, meaning that it cannot be created or destroyed, but only converted from one form into another; for instance, a battery converts chemical energy into electrical energy.

The aim of this is guide is to guide users on how to transform and use electric energy and electric power used for equipment and devices needed in the humanitarian interventions, including; understand basic electric concepts, knowing how to properly size installations, and how to efficiently manage electrical installations.

## Common Terms in Power Generation

**AC** Short for Alternating Current.

---

**DC** Short for Direct Current.

---

**Electrons** Small charged particles that exist as part of the molecular structure of materials.

---

**Free electron** An electron that is easily separated from the nucleus of the atom to which it belongs.

---

**Conductors** Bodies that possess free electrons (metals, for example, but also the human body and the earth).

---

**Insulators** Bodies that do not possess free electrons (e.g., glass, plastic and wood).

---

**Voltage (U)** The difference in charge between two points.

---

**Current (I)** The rate at which charge is flowing.

---

**Resistance (R)** A material's tendency to resist the flow of charge (current).

---

**Circuit** A closed loop that allows charge to move from one place to another.

---

---

**Resistor** Any material that allows electrical energy to be converted to thermal energy.

---

**Overload** Additional power available for a short amount of time.

---

**VRLA Battery** Short for Valve Regulated Lead Acid Battery.

---

**Absorption voltage Range** The level of charge that can be applied without overheating the battery.

---

**Float voltage Range** The voltage at which a battery is maintained after being fully charged.

---

**Distribution Panel** This is a circuit breaker and contains many electrical circuits. Using this, a circuit can be turned on or off.

---

**Circuit Breakers and Fuses** These protect wires from overheating and are found in the distribution panel box. When there is an overload, that is, too much current flowing, the fuses will blow or the circuit breakers will trip.

---

**Switches** Switches can energise circuits, that is, they allow a current to flow through. If carelessly used, these can cause damage to a person and to equipment. Receptacles connect the appliances to a circuit.

---

**Grounding/earthing** connecting metal parts of electric appliances to earth.

---

**(W)** Short for Watt, the Power unit measure.

---

---

**(Wh)** Short for Watt-hour, the Energy unit measure

---

**(V)** Short for Volts, the Voltage unit measure

---

**(A)** A Short for Ampere, the Electrical Current unit measure

---

## Comparison of UK-US Terminology

For the purpose of this guide US terminology is more frequently used.

UK	US
2-way lighting, switch	Switch 3-way lighting, switch
Cooker	Range
Distribution board	Distribution panel, breaker panel
Earth, earthing	Ground, grounding
Fitting	Fixture
Residual current device (RCD)	Ground fault circuit interrupter (GFCI)
Skirting board	Baseboard
Strapper	Traveler

---

## Electrical Basics

An electric current is a flow of electric charge in a circuit - the flow of free electrons between two points in a conductor. These free electrons in motion is what constitutes electrical energy. Electricity production consists of forcing electrons to move together in a conducting material by creating an electron deficit on one side of the conductor, and a surplus on the other.

The device that produces this imbalance is called a generator. The terminal on the surplus side is marked +, that on the deficit side -.

When a load is connected to the generator's terminals, the generator pushes electrons: it absorbs the positive charged particles and sends back the negatively charged particles. In a circuit, the electrons circulate from the - terminal to the + terminal.

To be able to use electrical equipment properly and safely it is important to understand electricity works. It is vital to understand the three basic building blocks required to manipulate and utilise electricity - voltage, current, and resistance - and how the three relate to each other.

## Electrical Charge

Electricity is the movement of electrons. Electrons create charge, which are harnessed to produce power. Any electrical appliance - a light-bulb, a phone, a refrigerator - are all harnessing the movement of the electrons to work. The three basic principles for this guide can be explained using electrons, or more specifically, the charge they create:

- **Voltage** - The difference in charge between two points.
- **Current (Ampere)** - The rate at which any given charge is flowing.
- **Resistance** - A material's tendency to resist the flow of charge (current).

These values describe the movement of charge, and thus, the behaviour of electrons.

A **circuit** is a closed loop that allows charge to move from one place to another. Components in the circuit allows to control this charge and use it to do work.

### Electric Measurements

- **Power** - The energy consumed by the load.
- **Energy** - The amount of electricity consumed or produced during a given period of time.

## Electric Potential Difference (Voltage)

Voltage (U) is defined as the amount of potential energy between two points on a circuit. This difference in charge between the + and - poles in a generator is measured in volts and is represented with the letter "V". Sometimes voltage can be called "electric pressure," an appropriate analogy because the force provided by electric potential difference to electrons passing through a conductive material can be compared to water pressure as water moves through a pipe; the higher the volts, the greater the "water pressure".

The available energy of the free electrons in motion is what constitutes electrical energy. Electricity production consists of forcing the electrons to move together through a conducting material by creating an electron deficit on one side of the conductor, and a surplus on the other. The terminal on the surplus side is marked (+), that on the deficit side (-).

Voltage is determined by the distribution network. For example, 220 V between the terminals of most electrical outlets, or 1.5V between the terminals of a battery.

## Electrical Current

An Electrical Current (I) is the flow of free electrons between two points in a conductor. As electrons move, an amount of charge moves with them; this is called current. The number of

electrons that are able to move through a given substance is governed by the physical properties of the substance itself conducting the electricity - some materials allow current to move better than others. Electrical current (I) is expressed and measured in Amperes (A) as a base unit of electrical current. Typically, when working with electrical equipment or installations, current is usually referred to in amperes. If volts (V) can be compared to the water pressure of water passing through a pipe, amperes (A) can be compared to the overall volume of water capable of flowing through the pipe at any given moment.

The motion of the free electrons is normally random, resulting no overall movement of charge. If a force acts on the electrons to move them in a particular direction, then they will all drift in the same direction.

**Diagram: Free electrons in a conductive material with and without current applied.**

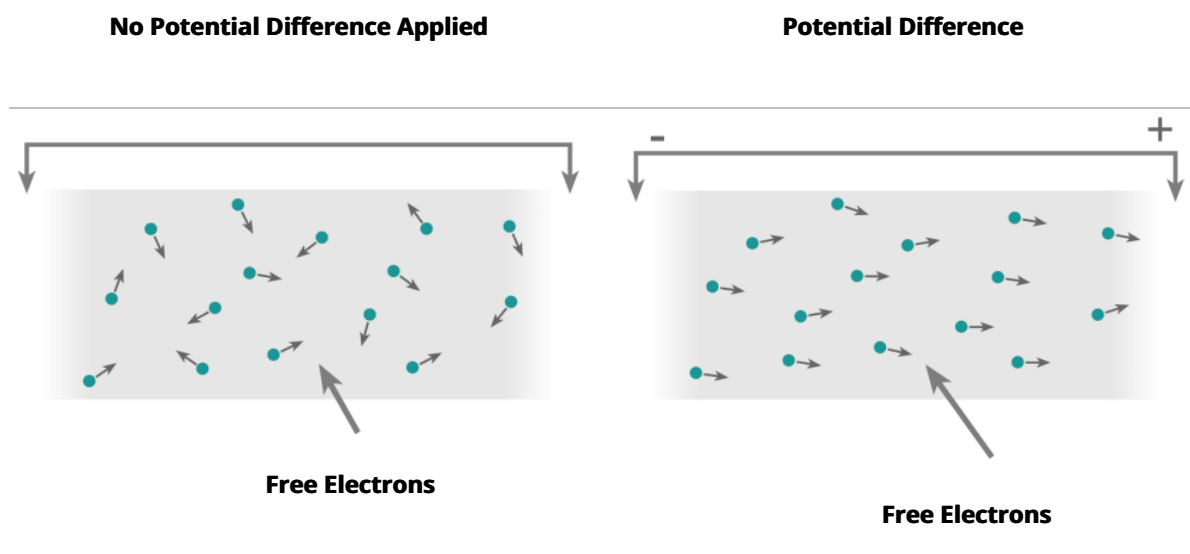

When a light bulb is connected to a generator, a certain quantity of electrons pass through the wires (filament) of the bulb. This electron flow corresponds to the current (I), and is measured in amperes (A).

Current is a function of: The power (P), The voltage (V), and the resistance (R).

$$I = U / R$$

## Resistance

Sometimes electrons are held within their respective molecular structures while other times they are able to move around relatively freely. The resistance of an object is the tendency of this object to oppose to the flow of electric current. In terms of electricity, the resistance of a conductive material is a measure how the device or material reduces the electric current flowing through it. Every material has some degree of resistance; it can be very low - such as copper (1-2 ohm per 1 meter) - or very high - such as wood (10000000 ohm per 1 meter). As an analogy to water flowing through a pipe, resistance is bigger when the pipe is narrower,

decreasing the flow of water.

In two circuits with equal voltages and different resistances, the circuit with the higher resistance will allow less charge to flow, meaning the circuit with higher resistance has less current flowing through it.

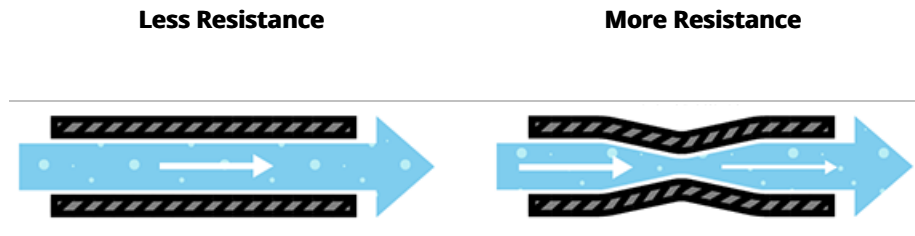

The Resistance (R) is expressed in ohms. Ohm defines the unit of resistance of “1 ohm” as the resistance between two points in a conductor where the application of 1 volt will push 1 ampere. This value is usually represented in schematics with the Greek letter “Ω”, which is called omega, and pronounced “ohm”.

For a given voltage, the current is proportional to the resistance. This proportionality, expressed as a mathematical relationship, is known as Ohm’s Law:

$$U = I \times R$$

$$\text{Voltage} = \text{Current} \times \text{Resistance}$$

For a constant voltage, increasing the resistance will reduce the current. Conversely, the current will increase if the resistance is lowered. At constant resistance, if the voltage increases, so will the current. Ohm’s Law is valid only for pure resistance, i.e., for devices that convert electrical energy into purely thermal energy. With motors, for example, this isn’t the case.

Electrical devices may have purpose-built resistors which limit the current that flows through a component, so that component is not damaged.

Resistance determined by load. For example, wire conductors with a larger cross section offer less resistance to current flow, resulting in a smaller voltage loss. Inversely, resistance is directly proportional to the length of the wire. To minimise voltage loss, a current needs the shortest possible wire with a large cross-section. (see [cabling](#) section) Note also that the kind of wire (copper, iron, etc.) also affects a cable’s resistance.

When the resistance in an electrical circuit is near zero, the current may become extremely large, sometimes resulting in what is called a “short-circuit.” A short-circuit will cause an overcurrent within the electrical circuit, and can cause damage to the circuit or device.

## Power

Electric power (P) is the amount of work done by an electric current in a unit of time. It



represents the amount of energy consumed by a device connected to the circuit. It is calculated by multiplying the voltage by the current, and is expressed in Watts (W).

$$P = U \times I$$

Power = Voltage  $\times$  Current

The more powerful the load, the more current it draws. This calculation is useful when analysing power needs.

### Power Vs. Energy

---

**POWER**

- Watts
- Kilowatts

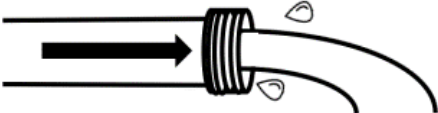

"like the flow rate of water"

---

**ENERGY**

- Watt-hours
- Kilowatt-hours

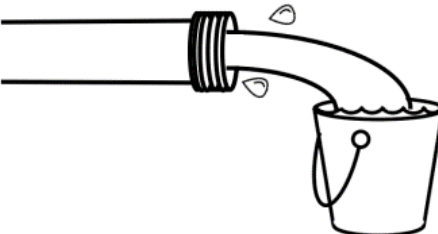

"like the water that ends up in the bucket"

---

Power is determined by the load.

A 40W light bulb plugged into a 220V outlet draws a current of  $40/220 = 0.18A$ .

**Example:** A 60W light bulb plugged into a 220V outlet draws a current of  $60/220 = 0.427A$ .

---

## Energy Consumption

Energy consumption is the amount of electricity produced or consumed during a given period of time. This is calculated by multiplying the power of a device by the duration of its use, expressed in hours, expressed in kilowatt-hours (kWh).

**Example:** A 60W light that's left on for 3 hours will consume 180Wh, or 0.18kWh.

---

This is the unit of consumption that adds up on the electric meter to determine any **electricity** bill.

Electric energy is often confused with electric power, but they are two different things:

- Power measures capacity to deliver electricity
- Energy measures total electricity delivered

*Electric energy is measured in Watt-hours (Wh), but most people are more familiar with the measurement on their electric bills, kilowatt-hours (1 kWh = 1,000-watt-hours). Electric utilities work at a larger scale and will commonly use megawatt-hours (1 MWh = 1,000 kWh).*

## Effects

Depending on the nature of the elements through which it passes, electric current can have several physical effects:

Effect	Description	Application Examples
<b>Thermal Effect</b>	<ul style="list-style-type: none"><li>• When a current pass through a material with electrical resistivity, electrical energy is converted into thermal (heat) energy.</li></ul>	<ul style="list-style-type: none"><li>• Lighting, electric heating.</li></ul>
<b>Chemical Effect</b>	<ul style="list-style-type: none"><li>• When a current is passed between two electrodes in an ionic solution, it causes an exchange of electrons, and thus matter, between the two electrodes. This is electrolysis: the current caused a chemical reaction.</li><li>• The effect can be reversed: by performing electrolysis in a container, a chemical reaction can create electrical current.</li></ul>	<ul style="list-style-type: none"><li>• Current creates chemical reaction: metal refining, electroplating.</li><li>• Chemical reaction creates current: batteries, storage cells.</li></ul>

---

Effect	Description	Application Examples
<b>Magnetic Effect</b>	<ul style="list-style-type: none"> <li>• Electric current passing through a copper rod produces a magnetic field.</li> <li>• The effect can be reversed: turning an electric motor mechanically produces current.</li> </ul>	<ul style="list-style-type: none"> <li>• Current produces a magnetic field: electric motors, transformers, electromagnets.</li> <li>• Magnetic field produces current: electric generators, bicycle dynamos.</li> </ul>
<b>Photovoltaic Effect</b>	<ul style="list-style-type: none"> <li>• When light or other radiant energy strikes two dissimilar materials in close contact produce an electrical voltage.</li> </ul>	<ul style="list-style-type: none"> <li>• Solar cell to produce electricity.</li> </ul>

*Adapted from MSF*

## Electrical Installations and Circuits

### Types of Current

Current delivering electricity to any device can come in two forms:

1. Direct Current (DC)
2. Alternating Current (AC)

When connecting any device to any circuit, it is important to know which form of current is being used.

There are devices that can convert current from one format to another, or from a higher voltage current to a lower voltage current and vice versa are universally referred to as "transformers." Any time voltage or current type is transformed, there will always be some energy loss, even if very small.

- A transformer that converts a higher voltage current to a lower voltage current is called a "step down" transformer, and works by either converting high voltage low current loads to low voltage high current loads, or by adding resistance between two circuits to limit the voltage output, resulting in lower power being received on the output side.
- A transformer that converts to a higher voltage is called a "step up" transformer, and works by converting low voltage but high currents into high voltage but low currents. A step up transformer does not add additional electrical power to the circuit, it only increases overall voltage.
- A transformer that converts a current from DC to AC is called an inverter, and physically induces an alternating current on the output side. Inverters typically consume electrical power for the conversion process, and thus are less energy efficient than other forms of

transformers.

- A transformer that converts a current from an AC to DC can be called a "battery charger" (for charging batteries) or a "power supply" (for direct powering of a radio, etc.), depending on how the conversion process works.

## Direct Current (DC)

The main characteristic of a Direct Current – or DC – is that the electrons within the current always flow in the same direction, from the side with a deficit to the side with a surplus. This is the kind of current supplied via the chemical effect by batteries, or via the photovoltaic effect by solar panels. The terminals are marked + and – to show the polarity of the circuit or generator. The voltage and current are constant in time.

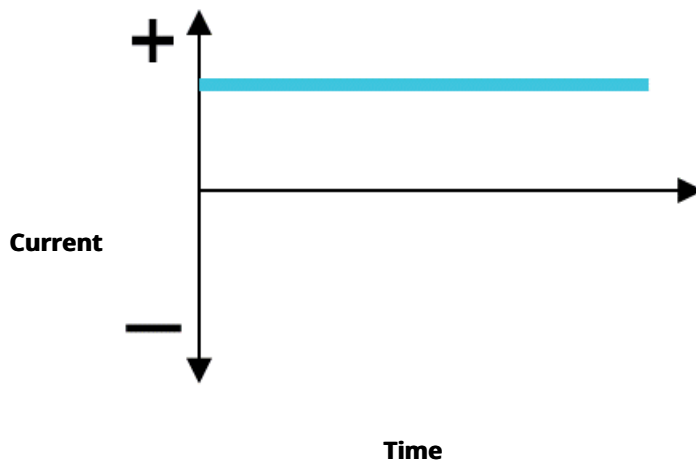

- 
- **Advantages:** Batteries can supply DC directly and it is possible to add the sources in parallel or series.
  - **Disadvantages:** In reality, the use of the batteries limits the voltage to a few volts (up to 24 volts in some vehicles). Those low voltages prevent the transportation of this type of current.

## Alternating Current (AC)

In alternating current – or AC - the electrons reverse direction at a given frequency. As the current continually alternates there is no fixed + or -, but "phase" and "neutral". Voltage and current follow a sinusoidal curve. While voltage and current continually vary between a maximum and minimum value, measurement masks this variation and shows a stable average value—such as 220V.

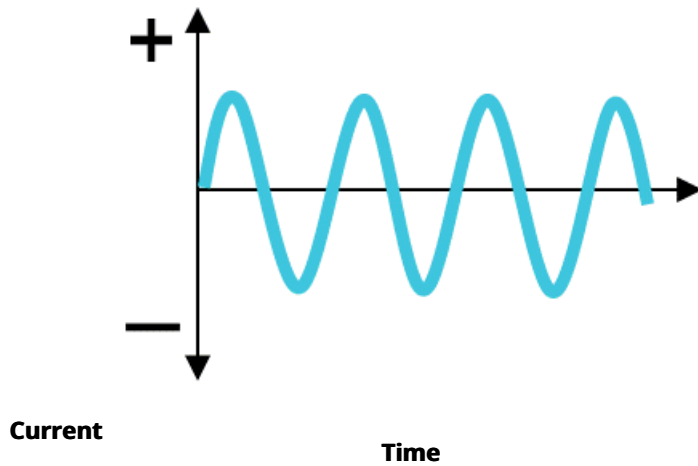

The frequency is defined as the number of sinusoidal oscillations per second:

- 50 oscillations per second in Europe (50Hz).
- 60 oscillations per second in the US (60Hz).

AC is the type of current supplied by electric utility companies because AC voltage can be increased and decreased with a transformer. This allows the power to be transported through power lines efficiently at high voltage and transformed to a lower, safer, voltage for use in businesses and residences. Therefore, it is the form of electrical energy that consumers typically use when they plug an appliance into a wall socket.

- **Advantages:** Can be transported over long distances without too much loss using high tension lines. It is easy to produce.
- **Disadvantages:** AC cannot be stored; it must be created. AC can also pose a greater health hazard for living organisms that come into contact with it.

There are two types of AC:

A single-phase current is the most common type of current, and thus is usually the configuration delivered by public networks, but also by a single-phase generator. A single-phase AC is supplied via two lines (phase and neutral), usually with a 220 V voltage difference between them. Plugs can be inserted in both ways.

Because the voltage of a single-phase system reaches a peak value twice in each cycle, the instantaneous power is not constant and is mainly use for lighting and heating but cannot work with industrial motors.

**Single-Phase** A single-phase load may be powered from a three-phase distribution transformer allowing stand-alone single-phase circuit to be connected a three-phase motor, an allowing a three-phase motor to be connected to all three phases. This eliminates the need of a separate single-phase transformer.

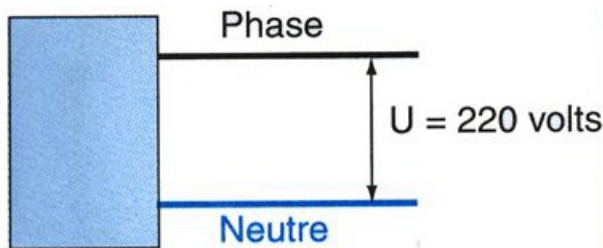

If there is an increased need for power, then consistency and balance pay a key role. Three-phase circuit is the common current configuration for electricity companies, and can also be produced with a three-phase generator. A three-phase current is the combination of three single phase currents.

To carry a given power with 3 separate single-phase cables, 9 wires are needed. To carry the same power in a three-phase cable, only 5 wires are required (3 phase, 1 neutral, 1 ground), which it is why there can be significant savings when properly planning a three-phase current. Cost savings include saving on wires, cables, and also in apparatus using or producing electricity. Three-phase motors or alternators will also be smaller than the single phase equivalents of the same power production.

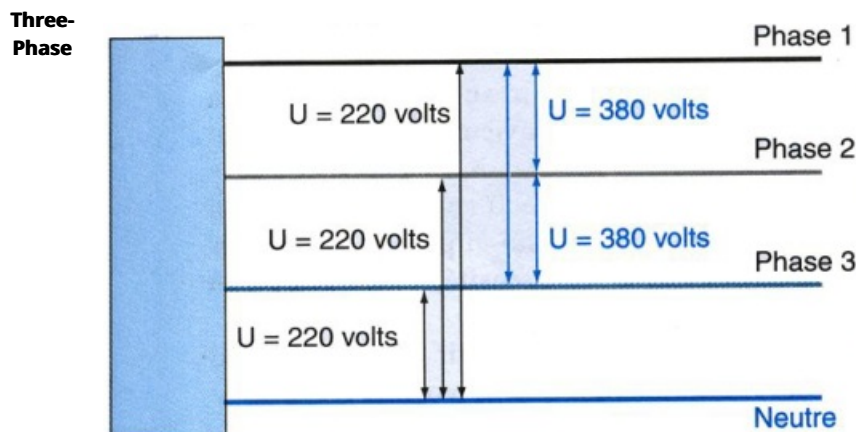

## Grouping Circuit Components

In every circuit there will be resistor(s) and generator(s), the numbers of which will depend of the power requisites. Both components can be grouped depending on the what is required to keep constant, the current or the voltage. There are two basic ways to groups components in series or in parallel. (additional information in [connecting batteries](#) section)

The basic idea of a “series” connection is that components are connected end-to-end in a line to form a single path through which current can flow:

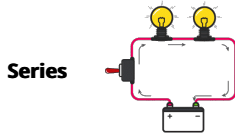

1. **Current:** The amount of current is the same through any component in a series circuit.
2. **Resistance:** The total resistance of any series circuit is equal to the sum of the individual resistances.
3. **Voltage:** The supply voltage in a series circuit is equal to the sum of the individual voltage drops.

The basic idea of a “parallel” connection is that all components are connected across each other’s leads. In a purely parallel circuit, there are never more than two sets of electrically common points, no matter how many components are connected. There are many paths for current flow, but only one voltage across all components:

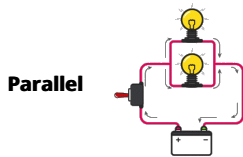

1. **Voltage:** Voltage is equal across all components in a parallel circuit.
2. **Current:** The total circuit current is equal to the sum of the individual branch currents.
3. **Resistance:** Individual resistances *diminish* to equal a smaller total resistance rather than *add* to make the total.

## Cable Sizes and Wiring

What ties all the components together in an electrical system are the cables. Cables supply the power from power sources for distribution to appliances, lights and equipment. Unfortunately, the most common installation error is to under-size cables relative to the load/s or from the recharge sources.

Proper installation is primarily a matter of sizing a cable to match its task, using the correct tools to attach terminals, and providing adequate over-current protection with fuses and circuit breakers. Cable sizing is fairly simple; it is a function of the length of a cable measuring from the power source to the appliance, and the current (amperage) that will flow through it.

The longer the cable, or the higher the amperage, the bigger the cable must be to avoid unacceptable voltage losses. There should always be plenty of extra margin for safety because an appliance may actually use more current than what it is rated for because of heat, low voltage, extra load, or other factors. There’s never a performance penalty if a cable is marginally oversized; there is always a performance penalty - and possibly a safety hazard - if it’s undersized.

The ground (negative) cable is as much a part of a circuit as the positive cable; it must be sized the same. In general, each appliance should be supplied from the distribution panel with its own positive and negative cables, although lighting circuits sometimes use common supply and ground cables to feed a number of lights (in which case the supply cables must be sized for the total load of all the lights). For 24v systems, the cables size is half that of a 12v setup. Always read product recommendations, or check with the supplier to know and understand exactly what size cable is required for the products.

To better plan and size cables, please reference the cable sizing table below:

Circuit Type	DC Amps
--------------	---------

	10% Voltage Drop (Non-Critical)	3% Voltage Drop (Critical)	5A	10A	15A	20A	25A	30A	40A	50A	60A	70A	80A	90A	100A	120A	150A	200A
	Cable Length in Meters	0-6 m	0-2 m	•	•	•	•	•	•	•	•	•	•	•	•	•	•	•
	6-9 m	2-3 m	•	•	•	•	•	•	•	•	•	•	•	•	•	•	•	•
	9-15 m	3-4.5 m	•	•	•	•	•	•	•	•	•	•	•	•	•	•	•	•
	15-19 m	4.5-6 m	•	•	•	•	•	•	•	•	•	•	•	•	•	•	•	•
	19-24 m	6-7.5 m	•	•	•	•	•	•	•	•	•	•	•	•	•	•	•	•
	24-30 m	7.5-9 m	•	•	•	•	•	•	•	•	•	•	•	•	•	•	•	•
	30-40 m	9-12 m	•	•	•	•	•	•	•	•	•	•	•	•	•	•	•	•
	40-51 m	12-15 m	•	•	•	•	•	•	•	•	•	•	•	•	•	•	•	•
	51-61 m	15-18 m	•	•	•	•	•	•	•	•	•	•	•	•	•	•	•	•
	18-21 m		•	•	•	•	•	•	•	•	•	•	•	•	•	•	•	•
	21-24 m		•	•	•	•	•	•	•	•	•	•	•	•	•	•	•	•
	24-27 m		•	•	•	•	•	•	•	•	•	•	•	•	•	•	•	•
	27-30 m		•	•	•	•	•	•	•	•	•	•	•	•	•	•	•	•
	30-33 m		•	•	•	•	•	•	•	•	•	•	•	•	•	•	•	•
	33-37 m		•	•	•	•	•	•	•	•	•	•	•	•	•	•	•	•
	37-40 m		•	•	•	•	•	•	•	•	•	•	•	•	•	•	•	•

The above cable sizing table is used by running across the top row until the column with the relevant amperage is found, and then moving down the left-hand column until the row with the relevant distance is reached. Wire sizes are denoted by colour coding.













**Gauge:**

A common way for referencing a cable size is its "gauge." The American Wire Gauge (AWG) is used as a standard method of denoting wire diameter, measuring the diameter of the conductor - measured as only the bare wire with the insulation removed. AWG is sometimes also known as Brown and Sharpe (B&S) Wire Gauge.

Below is a conversion chart from AWG/B&S to mm<sup>2</sup>. This table gives the closest equivalent size cross references between metric and American wire sizes. In Europe and Australia, wire sizes are expressed in cross sectional area in mm<sup>2</sup>.

Standard	Unit													
AWG	0000	000	00	0	1	2	4	6	8	10	12	14	16	



Standard	Unit													
Diameter (mm)	11.68	10.40	9.27	8.25	7.35	6.54	5.19	4.11	3.26	2.59	2.05	1.63	1.29	
Cross Section (mm <sup>2</sup> )	107.1	84.9	67.5	53.5	42.4	33.6	21.2	13.3	8.4	5.3	3.3	2.1	1.3	
Colour Code														

A printable guide to [sizing cables can be downloaded here](#)

Title

Guide - Cable Sizing Chart

File



## Colour Coding

While it is possible to use the same cables for AC and DC circuits, it is advisable to use different coloured cables between the two types of currents, both to increase handling safety but also to make installation and repair work much faster. If existing appliances or installations have colours, logistics managers may consider replacing or standardising them by re-colour coding the wires with an external paint or marking in a method that makes sense.

A general colour code for AC looks like:

- **Neutral:** Blue.
- **Phase:** Brown or black.
- **Ground:** Green/yellow.

The neutral and the phase are the two connections for the electricity, the ground is for safety.

















Colour code for DC (direct current, battery):

+ = red or blue

- = black or brown

Many differing international standards apply however. Please reference the below table for colour coding of different countries and regions around the world.









**Standard Wire Colours for Flexible Cable**  
**(e.g. Extension Cords, power cords and lamp cords)**

<b>Region or Country</b>	<b>Phases</b>	<b>Neutral</b>	<b>Protective Earth/Ground</b>
European Union (EU), Argentina, Australia, South Africa			
Australia, New Zealand	 	 	
Brazil	 		
United States, Canada	 (brass)	 (silver)	 (green) or  (green/yellow)









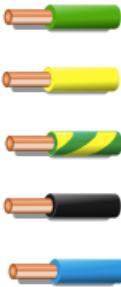

**Standard Wire Colours for Fixed Cables**  
**(e.g. In/On/Behind the wall wiring cables)**

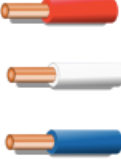
<b>Region or Country</b>	<b>Phases</b>	<b>Neutral</b>	<b>Protective Earth/Ground</b>
--------------------------	---------------	----------------	--------------------------------











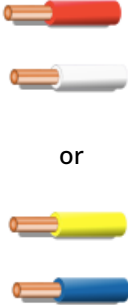

**Standard Wire Colours for Fixed Cables**  
**(e.g. In/On/Behind the wall wiring cables)**

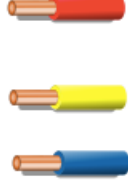

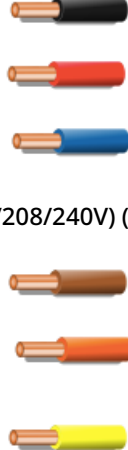



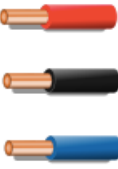

<b>Region or Country</b>	<b>Phases</b>	<b>Neutral</b>	<b>Protective Earth/Ground</b>
Argentina			
European Union and UK			
UK Prior to March 2004			 (formerly)

**Standard Wire Colours for Fixed Cables**  
**(e.g. In/On/Behind the wall wiring cables)**

Region or Country	Phases	Neutral	Protective Earth/Ground
Australia, New Zealand	<p>Any colours other than:</p>  <p>Recommended for single-phase:</p>  <p>Recommended for multi-phase:</p> 	 <p>or</p> 	 <p>(since 1980)</p>  <p>(since 1980)</p>  <p>bare conductor, sleeved at terminations (formerly)</p>
Brazil			

**Standard Wire Colours for Fixed Cables**  
**(e.g. In/On/Behind the wall wiring cables)**

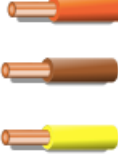
Region or Country	Phases	Neutral	Protective Earth/Ground
South Africa	 <p align="center">or</p>		  bare conductor, sleeved at terminations
India, Pakistan			
United States	 (120/208/240V) (brass)  (277/480V)	 (120/208/240V) (Silver)   (277/480V)	 (green)   bare conductor   (ground or isolated ground)

<b>Standard Wire Colours for Fixed Cables</b> <b>(e.g. In/On/Behind the wall wiring cables)</b>			
Region or Country	Phases	Neutral	Protective Earth/Ground
Canada	 (120/208/240V)		
	 (600/347V)	 (120/208/240V)	 (green)
	 (single-phase isolated systems)	 (600/347V)	 bare conductor
	 (three phase isolated systems)		 (isolated ground)

**Important points to note when wiring:**

- All circuits should be removed from the floor and be as high as possible with no connections in or near water or damp areas.
- All cable lug connections should be securely crimped to the wire termination with a band, and not soldered in place.
- Tinned cable – copper wire that has been coated with a thin layer of tin to prevent corrosion - It is preferable to use where possible in a marine environment or near salt water.
- Never tap into or splice existing circuits when installing new equipment; run a properly sized new duplex cable (positive and negative cable in a common sheath) from the

distribution panel (or a source of power) to the appliance.

- It is recommended to label all cables at both ends, and to an updated wiring plan to aid in future troubleshooting. Copies of the wiring plans can be even be stored in locations such as the fuse box or distribution box so that future users can reference them.
- Each circuit should have an independent ground cable, and all the ground cables should eventually be tied back to a common ground point/busbar.
- Unless in a conduit, cables should be physically supported at least every 450mm.
- Although black is often used for DC negative, it is also used for the live wire in AC circuits in the USA. That means there is potential for dangerous confusion. DC and AC wiring should be kept separate; if they have to be run in the same bundle, one or the other should be in a sheath to maintain separation and ensure safety.

## **Grounding and Protective Devices**

### **Protective Devices**

Protective devices for electrical circuits ensure that a high current cannot flow under faulty conditions, protecting the installation and equipment and preventing injury and harm to persons handling or in the near vicinity of equipment. Overcurrent protection is assured through physically detaching the power supply in a circuit, which removes fire hazards and risk of electrocution.

Protective devices might include:

- Fuses.
- Miniature Circuit Breakers (MCBs).
- Residual Current Devices (RCDs).
- Residual Current Breakers with Overcurrent (RCBOs).

All of the aforementioned devices protect users and equipment from faulty conditions in an electrical circuit by isolating the electrical supply. Fuses and MCBs only isolate the live feed; while RCDs and RCBOs isolate both the live and neutral feeds. It is essential that the appropriate circuit protection is installed to ensure an electrical installation is safe.

#### **Fuses**

A fuse is a very basic protection device used to protect the circuit from overcurrent. It consists of a metal strip that liquefies when the flow of current through it surpasses a pre-defined limit. Fuses are essential electrical devices, and there are different types of fuses available based on specific voltage and current ratings, application, response time, and breaking capacity.

The characteristics of fuses like time and current are selected to give sufficient protection without unnecessary disruption.



### **Miniature Circuit Breaker (MCB)**

An MCB is a modern alternative to fuses, and are usually centrally located in buildings – usually called a “fuse box” or “breaker box”, or attached to specific equipment. They are just like switches, turning off when an overload is detected in the circuit. The basic function of a circuit breaker is to stop the flow of current once a fault has occurred. The advantage of MCBs over fuses is that if they trip, they can be reset without having to replace the whole MCB. MCBs can also be calibrated more precisely than fuses, tripping at exact loads. Circuit breakers are available in different sizes from small devices to large switch gears which are used to protect low current circuits as well as high voltage circuits.



### **Residual Current Device (RCD)**

Residual Current Devices (or RCDs) are designed to detect and disconnect supply in the event of a small current imbalance between the live and neutral wires at a pre-defined value - typically 30mA. RCDs can detect when a live conductor touches an earthed equipment case, or when a live conductor is cut through; this type of fault is potentially dangerous and can result in electric shocks and fires.

An RCD does not give safety against a short circuit or overload in the circuit. It cannot detect – for example - a human being accidentally touching both conductors at the same time. An RCD cannot replace a fuse in function.

RCDs can be wired to protect a single or multiple circuits - the advantage of protecting individual circuits is that if one circuit trips, it will not shut down the whole building or



distribution system, just the protected circuit.



### **Residual Current Breaker with Overcurrent (RCBO)**

An RCBO combines the functions of a MCB and an RCD in one unit. RCBOs are a safety device which detects a problem in the power supply and is capable of shutting off in 10-15 milliseconds.

They are used to protect a particular circuit, instead of having a single RCD for the whole building.

These devices are testable as well as are able to be reset. A test button securely forms a tiny leakage condition; along with a reset button again connects the conductors after an error state has been cleared.



### **Grounding/Earthing**

Uncontrolled electricity can injure or even kill humans or animals. A common and effective way to control electricity is through grounding. Grounding is a physical connection to the earth that draws electric charge safely to the ground allowing a large space for electrons to dissipate away from humans or equipment. A grounding system gives excess positive charge in electrical lines access to a negatively charged ground wires, eliminating the dangers of fire and electrocution.

Some devices may have a "ground" symbol indicating where a grounding wire should be connected.



The term "ground" refers to a conductive body, usually the earth. "Grounding" a tool or electrical system means intentionally creating a low-resistance path to the earth's surface. When properly done, current from a circuit follows this path preventing the build-up of voltage that would otherwise result in electrical shock, injury and even death. Grounding is used to dissipate the damaging effects of an electrical short, but also used to prevent damage from lightening as well.

There are two ways to ground devices:

1. **System or Service Ground:** In this type of ground, a wire called "the neutral conductor" is grounded at the transformer, and again at the service entrance to the building. This is primarily designed to protect machines, tools, and insulation against damage.
2. **Equipment Ground:** This is intended to offer enhanced protection to the people. If a malfunction causes the metal frame of a tool to become energised, the equipment ground provides another path for the current to flow through the tool to the ground.

A major aspect to grounding to be aware of: a break in the grounding system may occur without the user's knowledge. Using a ground-fault circuit interrupter (GFCI) is one way of overcoming grounding deficiencies.

In tandem with a residual current device (RCD), grounding is essential to interrupting the power supply if there is an insulation fault—for example, if a live wire comes loose and touches the metal surface outside a piece of equipment. A ground wire channels the fault current into the earth, preventing injury to people. The earth connection picks up fault currents, allowing RCDs to measure them and trip.

When grounding circuit components and appliances, the cabling should have an electrical resistance below the maximum threshold of the main service breaker:

- 100Ω for a 500mA RCD
- 167Ω for a 300mA RCD
- 500Ω for a 100mA RCD

The lower the resistance, the better a grounding system will work.

## Grounding System Components

The connection between metal parts and grounding is made using a third wire in the electrical circuit. Ground wires usually have a green-yellow colour and must have the same gauge as the biggest wire used on the installation to protect.

To check if a grounding connection has been installed, look for the following points:

1. Plugs and sockets have a grounding pin.
2. Plugs with grounding pin are connected to a 3-wire network.
3. Ground wires are well connected to each other on the distribution board, normally through a grounding pad or a connecting strip in metal.
4. The grounding pad or the connecting strip is connected to the ground and this link must be done with a high-thickness wire (for example, 16mm<sup>2</sup>).
5. This wire is connected to the ground.

### Ground Connecting Cables in Use:

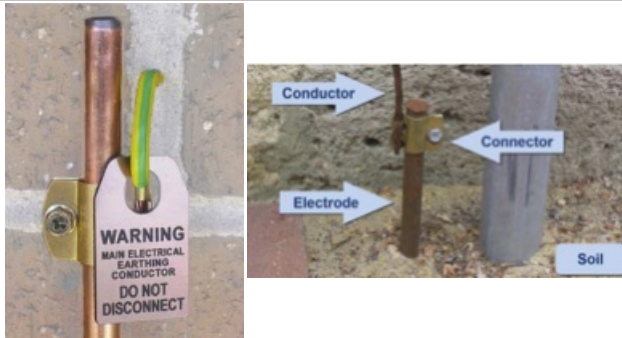

A grounding system typically consists of a grounding conductor, a bonding connector, its grounding electrode (typically a rod or grid system), and the soil in contact with the electrode. An electrode can be thought of as being surrounded by concentric rings of earth or soil, all the same thickness - each successive ring having a larger cross-sectional value and offers less and less resistance until a point is reached that it adds negligible resistance.

## Dangers/Precautions

Electricity is potentially dangerous and has inherent risks, especially from a circuit failure, misuse, inexperienced handling, or negligence. The effects on humans, appliances, and other objects can be devastating. When installing an electrical circuit, extending an existing circuit, or looking for a new office or guest house it is recommended to perform a full assessment on the facility. Full assessments should ensure that the circuit can safely handle the current flow needed, proper protection devices exist, the circuit is grounded, and there are no potential hazards.

For equipment, the dangers of an improperly installed or secured circuit are short circuits and overloads. For people, the dangers come from insulation faults that lead to direct or indirect contact with electrical currents.

### Short Circuit

A short circuit is a strong overcurrent of short duration. In single-phase systems, a short circuit occurs whenever the phase and neutral wires accidentally come into contact; in three-phase systems, this can occur when there is contact between two of the phases. For DC, a short circuit can occur when the two polarities come into contact.

Short circuits can also occur when there is a break in the insulation surrounding a cable, or when two conductors come in contact via an external conductor (example: a metal hand tool) or water bridges the connections of the lines, causing the resistance of the circuit to become close to zero and thus reaching high values ( $U=RxI$ ) very quickly.

Physical damage can expose cables inside of insulation, while a sudden temperature increase of the conductors can cause the insulation and copper cores to melt.

### Overload

An overload is caused by a weak overcurrent occurring over a long duration. Overloads can be

caused by a current that is too high to be conducted through the relative diameter of the conducting cable.

There are two kinds of overload:

- Normal overloads, which can occur when a motor starts up. Normal overloads are short-lived and pose no danger.
- Abnormal overloads occur when too many appliances are connected to the same circuit or the same outlet at the same time, or when a connection terminal isn't properly tightened. These problems are common in old buildings with too few outlets, but can occur on any installation as the number of electric devices increase. The current is lower in an abnormal overload than that of a short circuit, but the results are identical: overheated wires, damaged insulation, high risk of fire.

## **Insulation Faults**

Insulation faults are caused by damage to the insulation of one or more phase conductors. These problems can lead to electrical shocks from current-carrying lines, and if the damaged conductor touches a metal surface or casing, can cause appliance and equipment to be electrified to the touch as well.

An insulation fault can also be caused by moisture from water damage or natural humidity in walls.

These faults can be very dangerous, especially when a person comes into direct contact with the conductor, a metal casing, or a defective electrical appliance. In all cases the human body becomes part of the electrical circuit causing an electric shock.

## **Injury from Electrical Exposure**

The damage to a human body is done by 3 factors:

- The amount of current flowing through the body.
- The pathway of the electricity entering the body.
- The duration of the body's exposure to the electricity.

The below table and image details the general response of a human body to different strengths of electrical current. The arrows show the flow of electricity from the point of entry to the nearest exit point. The blue arrow shows the flow of current through the head / heart then to ground, which is the most lethal.



### Reaction

- 
- Painful shock

---

  - Muscle contraction - "Cannot Let Go" danger

---

  - Lung paralysis, usually temporary

---

  - Ventricular fibrillation, usually fatal

---

  - Certain ventricular fibrillation, fatal

---

  - Heart paralysis, severe burns

---

### Safety Equipment

To avoid or reduce the damaging effects current can have in a human body, is highly recommended to use protective equipment and take precautions when handling electrified circuits and equipment.

- Rubber Gloves – To prevent hands from directly making contact with the current. They must be close fitting and have an excellent grip.
- Tight Sleeves and Trouser Legs – To prevent unintentional contact or being pulled into dangerous equipment.
- Remove rings from fingers.
- Rubber Boots – To prevent the body from forming a complete conducting electrical circuit.

### Electrical Hazards

If an installation is properly set up, grounded and well maintained, electrical shorts or other issues should not be a problem. If the basics of installation, handling, maintenance are neglected, several hazards can occur.

Hazards	Description	Possible Sources







Hazards	Description	Possible Sources
<b>Shocks</b>	<p>Electric shock occurs when the human body becomes part of the path through which current flows.</p> <p>The direct result is electrocution. The indirect result is injury resulting from a fall or uncontrolled movement.</p>	<ul style="list-style-type: none"> <li>• Electrical cords can cause trip hazards.</li> <li>• Frayed power cords are dangerous.</li> <li>• Overloading electrical sockets.</li> <li>• Damaging cords by running over them or placing heavy objects on them</li> <li>• Improperly modifying electrical plugs.</li> <li>• Overheating machinery by not having adequate ventilation.</li> <li>• Damaged electrical outlets.</li> <li>• Exposed wires.</li> <li>• Working close to power sources.</li> <li>• Overhead lines hanging low or falling.</li> <li>• Water dripping on live equipment.</li> </ul>
<b>Burns</b>	<p>Burns can result when a person touches electrical wiring or equipment that is energised.</p>	
<b>Arc-Blast</b>	<p>Arc-blasts occur from high-amperage currents arcing through the air. This can be caused by accidental contact with energised components or equipment failure.</p> <p>The three primary hazards associated with an arc-blast are:</p> <ul style="list-style-type: none"> <li>• Thermal radiation.</li> <li>• Pressure waves.</li> <li>• Projectiles.</li> </ul>	
<b>Explosions</b>	<p>Explosions occur when electricity provides a source of ignition for an explosive mixture in the atmosphere.</p>	
<b>Fires</b>	<p>Electricity is one of the most common causes of fires both in the home and in the workplace. Defective or misused electrical equipment is a major cause of electrical fires.</p>	

## Hazard Signs

Safety signs keep persons aware of hazards. It is important to located them accordingly so persons working around the hazard can take proper precaution. They should be in visible places and include the maximum possible information about the source of and properties of the danger. In case of an incident, this information can be a valuable information.

Example of these signs include:

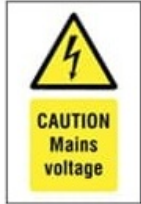

Voltage Warning Labels	Electrical Voltage Symbol	Danger of Death from Electricity Warning	Switch Off when not in Use
			
Electric Shock Warning	High Voltage Warning	Overhead Cables Warning	Live Wires Warning
			
Buried Cables Warning	Mains Voltage Warning	Danger - Do not Enter Sign	Warning - Isolate Before Removing Cover

## Electrical Fires

Electricity is one of the most common causes of fire. Electrical current and the chemical reaction of fire are both methods of transferring energy; while electricity involves the movement of negatively charged electrons, a flame consists of the dispersal of both positive and negative ions. Therefore, faulty wiring for example can cause arcing and sparking that can easily become a flame if the conditions to produce a fire are present, such as oxygen, heat or any kind of fuel.

Power sources that are directly related to electrical fires can be any of the following:

- Faulty wiring.
- Overloaded devices.
- A short circuit.
- Power cord damage.
- Overloaded electrical outlets.
- Improperly installed light fixtures.

Part of avoiding an electrical fire includes properly sizing, using and maintaining the electricity system, however hazards can occur regardless and fire suppression tools should be in place. Fire extinguishers are the most reliable mean to do it, however the appropriate fire extinguisher must be used or the extinguisher itself may be ineffective.

Fire Extinguisher Classes Per Region:

American	European	UK	Australian/Asian	Fuel/Heat Source
Class A	Class A	Class A	Class A	Ordinary combustibles
Class B	Class B	Class B	Class B	Flammable liquids
	Class C	Class C	Class C	Flammable gases
Class C	Unclassified	Unclassified	Class E	Electrical equipment
Class D	Class D	Class D	Class D	Combustible metals
Class K	Class F	Class F	Class F	Kitchen Grade (Cooking oil or fat)

Electrical fires need to be put out by a non-conductive substance, unlike the water or foam found in class A fire extinguishers. If someone attempts to put out an electrical fire with something like water, there is a high risk of electrocution since water is conductive. Class C fire extinguishers use monoammonium phosphate, potassium chloride, or potassium bicarbonate, which do not conduct electricity. Another option is a class C extinguisher that contains carbon dioxide (CO<sub>2</sub>). CO<sub>2</sub> is great for suppressing fires because it takes the fire's oxygen source away as well as diminishes the fire's heat since the CO<sub>2</sub> is cold when expelled from the extinguisher.

## Prevention

Prevention is the most effective measure to mitigate risk. Some of these preventive measures planners can take when working around electricity include:

- Never plug appliances rated at 230 V into an 115V electrical socket.
- Place all lamps on level surfaces and away from things that can burn.
- Use bulbs that match a lamps' rated wattage.
- Do not overload an electrical outlet by connecting several devices into a single receptacle using any device.
- Do not tug or pull any electrical cords.
- If an outlet or switch is feeling warm, shut off the circuit and call an electrician to check the system.
- Follow manufacturer's instructions for plugging a device into an electrical outlet.
- Avoid running extension cords under carpets or across doorways.
- Do not connect the cord of an old electrical device to a newer cord.
- Replace and repair frayed or loose cords on all electrical devices.
- Keep all electrical appliances away from water.
- Contact electricity authority if any damage done to overhead cables, outdoor panel boxes, or trees touching high voltage lines is seen.
- Review architectural drawings and/or contact electrical authorities before doing any work involving digging.
- Take heed to all warning signs indicating electrical hazards.



- Ensure a fire extinguisher is placed where the likelihood of a hazard occurring is great.
- Always wear safety equipment when around electrical equipment.

## Energy Management

Most humanitarian interventions - and especially the ones performed during emergencies - take place in remote or jeopardised communities with a poor availability and/or limited reliability of the electrical public grid. To operate, humanitarian organisations premises are frequently equipped with at least one independent power supply, either as back up in case of grid failure or as the primary method of producing electricity. Independent power supplies include batteries, generators and solar-electric equipment.

Purchasing, installing and running such equipment requires important investments that can be reduced with proper sizing and energy demand management. Electricity is not cheap, and running a generator can become quite expensive. Energy production also has an environmental impact and has the potential to damage the perception of organisations.

It is often possible to reduce electricity consumption without degrading the quality of service by improving the energy management, focusing on reducing the demand, and choosing the correct supply.

- **Energy Demand Management:** Minimise energy consumption without reducing the quality of service and avoid unnecessary energy consumption.
- **Energy Supply Management:** Select the best main and back-up power supplies in accordance with the situation, properly sized to optimise investment and running costs.

To manage both demand and supply, a proper diagnostic to understand the installation power and energy needs is required. Continued diagnostics will be necessary at each step of the energy management process, mainly:

- To calculate the total energy and power needs of a planned operating environment and help size the power supplies (generator, solar, or other).
- To identify the appliances and services that account for a significant part of the total energy and power needs.
- To understand the variation of the power and energy needs within a day and identify the peak periods.

A complete diagnostic may also be useful in reporting, audits and/or studies purposes.

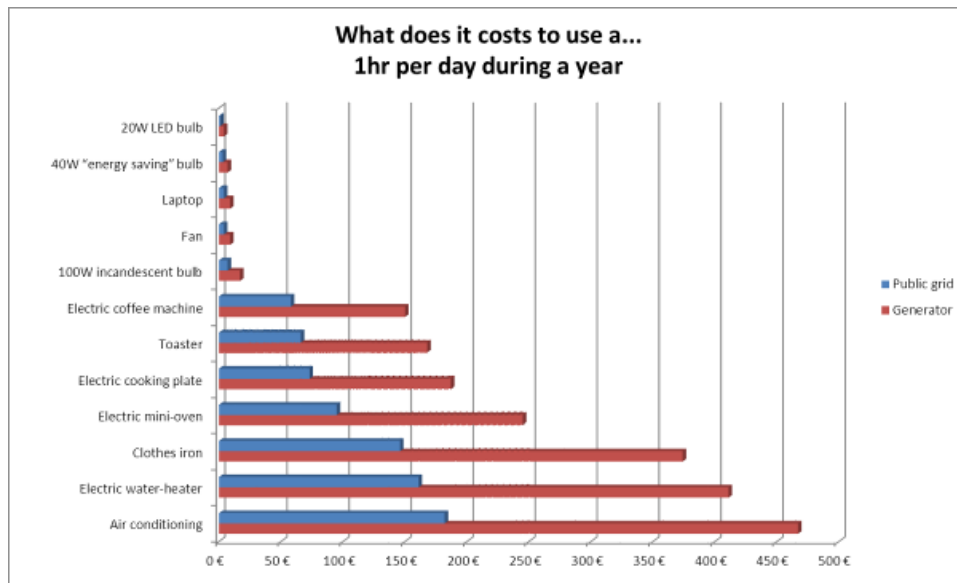

*Adapted from, ACF*

## Energy Demand Management

It is normal to take electricity for granted, however energy always comes at a cost. To improve the way the energy is used, avoid unnecessary consumption and minimise the inevitable without degrading the quality of the service. It is important to think in terms of service instead of devices, and try to find the most effective solutions to accomplish the required service.

**Service Requirement:** A cool working environment is required, not air conditioning.

**Example: Fulfilling the Service Requirement:** Consider choosing the room location least likely to heat up, installing white curtains that allow light to enter but reduce the heat, increase the insulation in a room, and then installing an air conditioner.

With the help of the energy diagnostic:

- **Identify high-impact services** to understand what services have significant impact on power and energy consumption and when the peak periods occur.
- **Examine potential alternatives** – working tools, refrigerators, and lighting are obvious consumers of electricity and hard to avoid. Other consumers of energy offer other possibilities, such as water heaters and stoves. Consider possible solutions according to feasibility and initial cost, energy consumption and running cost and service quality.
- **Reduce losses, increase efficiency** by choosing efficient and well-sized appliances according to the purpose and number of users, and by using them in a way that maximises their efficiency, such as cleaning and maintaining equipment and appliances to increase their efficiency.
- **Reduce unnecessary use** by switching off and unplugging appliances when not in use. It may be required to display posters or leaflets to reminder users.
- **Optimise consumption over time**, identifying peak periods and if possible, avoid or postpone the use of the most powerful appliances during peaks or when running on battery/solar back-up systems. Mark powerful appliances who's use can be postponed, such as those for comfort or non-urgent tasks, and differentiate those used for work, security, communications.

# Energy Supply Management

Proper selection of main and back-up power supply will have a large impact not only on cost savings, but in the way the energy consumption is optimised. The chosen combination must be able to:

- Deliver enough power for the installation.
- If possible, guarantee a 24/7 availability of electricity in the building.
- Ensure a minimum quality (limited voltage drop or frequency fluctuations).
- Minimise costs.
- Run and operate safely.
- Keep the impact on the local environment as low as possible, including reducing smoke, vibrations, noise during the night, ensure good living and working conditions and prevent neighbourhood conflict.
- Minimise the global environmental impact.

The decision on the type of main power supply will depend mainly if the building is connected to the public electricity grid. Connection to a public grid is considered optimal where available and should be the first option if available. If there is no grid, or the grid is not reliable, then a generator be considered.

A back-up or generator can and will be required if a grid runs the risk of power outages, or when a redundant electrical system is required as an essential safety measure.

There are multiple options for a back-up system, including batteries, solar or smaller generators. There are other things to take into account when selecting a back-up system, including what and how reliable the main source is.



Buying a generator may not be very expensive, but generators require fuel and maintenance and running costs can be quite high. Inversely, battery and solar systems require significant investments but will have very low running costs. Initial and running costs must be considered when choosing a power supply.

Estimated Operating Costs:

Proposed Back-up	Initial Cost	Total Cost After 1 Year	Total Cost After 2 Years
2kVA Generator	600 €	14,600 €	28,800 €
Battery System	4,800 €	9,300 €	13,900 €
Solar (cover ring 30% of energy needs)	6,500 €	9,600 €	12,900 €

## Main, Back-up and Possible Combinations

## Public Grid + Generator

In many contexts, the main power supply is the electricity provided by the local power company. A back-up is a generator should be able to cover all electricity needs of the installation excluding appliance marked as non-essential. (See energy demand management).

Advantages	Disadvantages
<ul style="list-style-type: none"><li>• Simple and cheap</li><li>• Locally available</li><li>• Limited nuisances</li></ul>	<ul style="list-style-type: none"><li>• Short outages occur as the generator must be started when the grid go down</li><li>• UPS and/or regulator necessary</li><li>• Fuel supply and stock necessary</li><li>• Maintenance required for the generator even if it is rarely used</li></ul>

### Recommended For

- Building connected to a public grid with long unpredictable outages
- Building connected to a public electricity grid in a deteriorated security context
- Building connected to a public electricity grid and used for a limited duration
- Emergency back up when required

## Generator + Generator

In a generator only configuration, electricity is provided by a two or more generators. For using two generators:

- Both generators can either be identical or capable of producing the same amount of power, and can be used interchangeably and following a detailed use plan.
- One generator can be smaller than the other, and be used as a back-up only. In the case of two differently powered generators, the smaller unit it will not need to or be able to cover the entire electricity needs of the operating context, and may need to be wired specifically to power essential items only (see energy demand management).

Advantages	Disadvantages
<ul style="list-style-type: none"><li>• Locally available</li><li>• Limited initial costs</li><li>• Well-known technology</li></ul>	<ul style="list-style-type: none"><li>• High running cost</li><li>• Short outage as generators are switched</li><li>• UPS and/or regulator required</li><li>• Fuel supply and stock required</li><li>• Limited reliability and frequent maintenance</li><li>• Time consuming to manage</li><li>• Permanent noise and maintenance hassle</li></ul>

### Recommended For

- Isolated building with high energy needs
- Isolated building used for a limited duration
- Emergency back up when required

## Grid + Batteries

In this configuration, the main power supply is the electricity provided by a local power company, while the back-up is a battery system that provides a limited autonomy to the installation in case of outage.

Advantages	Disadvantages
<ul style="list-style-type: none"><li>• 24/7 electricity without outage and micro-outage</li><li>• High reliability</li><li>• Good electricity quality</li><li>• Easy to add solar supply</li><li>• Limited nuisances</li></ul>	<ul style="list-style-type: none"><li>• Grid dependent</li><li>• Local procurement and maintenance not always possible</li><li>• Battery room required</li><li>• Higher initial cost than a generator</li><li>• Back-up generator may still be necessary</li><li>• Limited lifespan of the batteries (2 to 5 years) and possible environmental impact of batteries disposal</li></ul>

### Recommended For

- Building connected to a public grid with short and frequent outages
- Building connected to a public grid with night outages
- First step towards solar system installation

## Generator + Batteries

In this configuration the main power supply is a generator that provides electricity during peak hours. The back-up is a battery system that accumulates electricity when the generator is running and supplies the installation during low consumption hours.

Advantages	Disadvantages
<ul style="list-style-type: none"><li>• 24/7 electricity without outage or micro-outage</li><li>• No nuisance during low consumption hours</li><li>• Good electricity quality</li><li>• Better reliability and service-life of the generator</li><li>• More flexibility on power consumption</li><li>• Easy to add solar supply</li></ul>	<ul style="list-style-type: none"><li>• Fuel supply and stock required</li><li>• Minimum daily running duration for the generator to reload batteries</li><li>• Local purchase and maintenance may not be possible</li><li>• Battery room required</li><li>• Higher initial cost than generator alone</li><li>• Back-up generator may still be necessary</li><li>• Limited lifespan of the batteries (2 to 5 years) and possible environmental impact of battery disposal</li></ul>

### Recommended For

- Isolated office or compound
- First step towards Solar system installation

## Public Grid OR Generator + Solar

In this configuration, electricity is provided by the main source - grid or generator - during peak hours and by solar system during the day. A battery system accumulates electricity from

all sources and supplies the installation when they are off.

<b>Advantages</b>	<b>Disadvantages</b>
<ul style="list-style-type: none"><li>• Same as “grid/generator + battery”</li><li>• Lower nuisances</li><li>• Fuel saving, best cost/efficiency ratio on the long run for isolated building</li><li>• Very reliable back-up power supply</li></ul>	<ul style="list-style-type: none"><li>• Could require some time to be installed.</li><li>• Local purchase and maintenance may not be possible</li><li>• Battery room and a large open surface required</li><li>• High initial cost</li><li>• Limited lifespan of the batteries (2 to 5 years) and possible environmental impact of battery disposal</li></ul>

---

#### **Recommended For**

---

- Isolated guest-house
  - Isolated building with limited energy needs
  - Isolated building in area where fuel supply is very difficult and/or very expensive
  - Building where security context impose a very reliable and totally autonomous back-up power supply, such as places with possible hibernation requirements.
- 

## **Generators Systems**

A generator is a combination of an engine (prime mover) that produces mechanical energy from fuel and an electrical generator (alternator) that converts mechanical energy into electricity. These two parts are mounted together to form a single piece of equipment.

Mechanical generators as a source of power are common in the humanitarian sector apart from the public grid, mainly because they are usually available and can be acquired and installed relatively quickly almost everywhere. Generators are built on a well-known technology and it may not be hard to find a good technician to install one in many contexts. However, operating a generator is expensive, requires frequent and complex maintenance as well as a constant fuel supply. Generators can also cause many problems, such as noise, vibration, pollution, and more.

Generators are useful mainly in three types of situations:

- As a main power supply when there is no public electricity grid available or when the grid has a very poor reliability.
- As a back-up power supply when investing in a more efficient power supply is not possible: emergency, short-term installation, etc.
- As a back-up power supply for buildings with very large energy needs (mainly buildings equipped with air-conditioning or electric heaters).
- As a back-up power supply for installations that holds cold chain capacities.

In any other case, a more complete evaluation should be performed to assess alternatives to the generator. When considering a generator as a main or back-up power, do not underestimate the time required for handling the equipment nor to include in the budget the preparation of its installations.

## **Characteristics**

The following are the main characteristics to consider when selecting the appropriate equipment to cover needs.

## Generator Power

The first thing to evaluate when looking for a generator is its size - how much power can it generate?

### Example Standard Label on the Side of Generator

Power Generation				
Plot No. B-2, SEZ Industrial area, Nandad, Dist-satara, India 415523				
Generating Set ISO 8528	G2	SPEC-G		
Model Number	C22D5			
Serial Number	G201148709			
Manufacturing Order Number	A044B085			
Year of Manufacture	7-2020			
Generating Set Max Mass-Wet kg	965			
Controller	PS0600			
Declared Rating	ESP	PRP	COP	LTP
Rated Power (KVA)	22.0	20.0		
Rated Power (KW)	17.6	16.0		
Rated Current (A)	31.8	28.9		
Rated Voltage (V)	400	400		
Rated Frequency (Hz)	50	50		
Rated Power Factor	0.8	0.8		
Declared Rating: Enclosed Noise	Standby	Prime		
Average @ 1m dB(A)	-	73		
Average @ 7m dB(A)	-	63		
Average @ 15m dB(A)	-	57		
				
Lwa: 50 Hz @ 75%Prime as Per 2000/14/EC Directive				

Power rating is standardised as ISO-8528-1. The most common standards are:

ISO Generator Rating	Load Rating	Run Time Limitations
<b>Prime Rated Power (PRP)</b>	Rated for a variable load	This power is available during unlimited hours of usage with variable load factor. An overload of 10% is possible during maximum 1 hour every 12 hours but not exceeding 25 hours per year.
<b>Continuous Operation Power (COP)</b>	Rated for a constant load	This power is available during unlimited hours of usage with a fixed load factor. No overload allowed.

ISO Generator Rating	Load Rating	Run Time Limitations
<b>Emergency Stand By Power (ESP)</b>	Rated for a variable load	This power is available only during 25 hours per year with variable load factor. 80% of this power is available during 200 hours per year. No overload allowed.

### Load Types

Variable Load

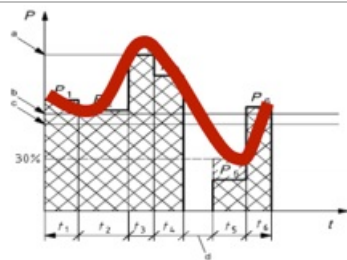

Constant Load

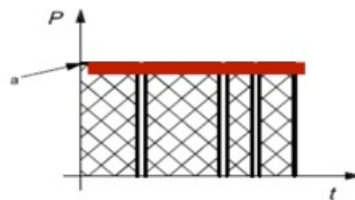

**Most of the time, only PRP is relevant when purchasing a generator.** When acquiring a generator, check if the power of the generator is indicated without reference to a standardised rating method. If no rating model is indicated, consult with the manufacturer or obtain documentation from the seller.

Power can be rated either in watt (W), kilowatt (kW), volt-amperes (VA) or kilo-volt-amperes (kVA). For the sake of clarity, 1kW = 1000W and 1kVA = 1000VA

A rating in watts indicates a **real power (P)**; a rating in volt-amperes indicates an **apparent power (S)**. Only real power has to be considered when planning consumption. Real power is the power actually consumed or utilised in an AC Circuit, and therefore it is the way power needs and energy consumption is calculated in a diagnostic exercise.

If only the apparent power (in kVA) is indicated, you can evaluate the real power with the following general formula:

$$P(W) = S(VA) \times 0.8$$

0.8 of apparent power is the assumed real power factor. This may vary from one machine to another, but 0.8 is a reliable average value.

When selecting a generator, it will at the very least need to accommodate the power calculated in the diagnostic exercise. However take into account the following precautions:

**Do not confuse kW and kVA:** The installation power needs are commonly calculated in kW while the power of the generator is usually rated in kVA. In that case, divide by 0.8 (or add 20%)



to convert the power of the installation from kW to kVA.

If the assumed energy needs of an installation are 6,380W, how do we size the generator and what KVA must it be?

The power of the generator must be at least 6.4kW PRP while. To determine the kVA:

**Example:**

$$6.4 / 0.8 = 8\text{kVA PRP}$$

A power need of 6,380W requires a generator of a minimum of **8kVa**.

---

**Take lower operating rates (derates) into account** The power a generator can provide decreases with increases in altitude and temperature. The following chart indicates correlations in environmental factors to derates:

<b>Altitude Derate</b>		<b>Temperature Derate</b>	
≤150m	No derate	≤30°C	No derate
300m	-1.8%	35°C	-1.8%
500m	-4.1%	40°C	-3.6%
1000m	-9.9%	45°C	-5.4%
2000m	-21.6%	50°C	-7.3%
3000m	-33.3%	55°C	-9.1%

Note that temperature inside the generator room can be far higher than ambient temperature.

A generator has an apparent power of 10kVA, and will operate at 1,000m elevation, and in a generator room with an average temperature of 45°C. What will the anticipated power output be:

Elevation adjustment:

**Example:**  $10\text{kVa} \times (1 - 0.099) = 9.01\text{kVA}$

Average temperature of 45°C:

$$9.01\text{kVa} \times (1 - 0.054) = 8.52\text{ kVA}$$

The "actual" apparent power is **8.52 kVa**.

---

## Rotation Per Minute (RPM)

Generators' engines usually have either:

- 1,500 RPM: intended for intensive usage (running more than 6 hours) capable to reach high power.
- 3,000 RPM: intended for short term usage, with better power/volume and power/weight ratios but higher hourly consumption of fuel.

1500 RPM generators should be preferred by most humanitarian actors.

## Noise Level

An engine is very noisy while running. Noise level is an important consideration while looking for a generator, as it is usually running during working or resting hours. A continuous noise even at very low level can become exhausting over long period of time.

Noise levels are indicated in dB(A) LWA. For comparison purpose here are some common sounds.

Common Source of Sound	dB(A) Level
Refrigerator at 1 m distance	50 dB(A)
Vacuum Cleaner at 5 m distance	60 dB(A)
Main road at 5 m distance	70 dB(A)
High traffic on an expressway at 25 m distance	80 dB(A)
Petrol Lawnmower	90 dB(A)
Jackhammer at 10 m distance	100 dB(A)
Discotheque	110 dB(A)
Threshold of pain	120 dB(A)

An average office should be around 70dB(A), while noise level in a bedroom at night should be lower than 50dB(A).

Note that when comparing noise levels at different distances:

- dB(A) @ 4 meters  $\square$  dB(A) LWA - 20.
- Noise level decreases by 6dB each time the distance from the source doubles.

There is a 97 dB(A) LWA generator in a generator room located at 15 meters from a building. What volume will be heard in the building?

97dB(A) LWA is equivalent to 77dB(A) @ 4 meters

77dB @ 4m = 71dB @ 8m

**Example:**

71dB @ 8m = 65dB @ 16m

The noise level in the building will be approximately **65 dB(A)**, maybe lower depending on the acoustic isolation of the generator room and the office. This is an acceptable level for an office but not for a guest-house at night.

---

In general, is recommended not to use generators that produce a noise level higher than 97 dB(A) LWA. If the generator will be used at night, it is recommended to use an acoustic canopy, or build a sound wall to dampen some of the noise pollution.

## **Tank Capacity**

A generator cannot be refuelled while it is running, thus the tank capacity is one of the main factors determining autonomy. A conservative estimation of a 1500 RPM generator hourly consumption is 0.15 L x rated power. A fuel tank must be chosen accordingly.

An 8kVA PRP generator powers an office without refuelling it during working day (10 hours). Knowing these numbers, what is the suggested tank size?

The hourly fuel consumption of that generator is:

$0.15 \times 8 = 1.2\text{L} / \text{hr}$

**Example:**

The calculation for the fuel tank is:

$1.2 \times 10 = 12\text{L}$

Then the fuel tank capacity must be at least **12L**

---

It is not recommended to run a tank below 1/5 of its capacity; low tank volumes can draw

particles and debris settled on the bottom of the tank into the fuel line, and is potentially dangerous for the engine.

## **Fuel**

Generators – like vehicles - can use either diesel or gasoline, and come with advantages and disadvantages. Diesel generators are more expensive, however diesel is often cheaper than gasoline and diesel generators have better power/volume and power/weight ratios than gasoline generators.

The choice of fuel must be determined according to the local price and availability of both type of fuel. One point to consider is what type of fuel vehicles in the organisations use, using the same fuel for both generators and vehicles can reduce complexities of keeping multiple types of fuel in stock. Safety may also be a concern for very large stock quantities of fuel - diesel fuel also has a significantly higher flash point than gasoline, meaning it will ignite in the open air only above 52°C while gasoline can ignite in below freezing temperatures.

## **Security**

Generators must be equipped with a residual current circuit breaker, so that power surges and short circuits can trip the breaker locally, making it easier to reset and preventing damage from occurring further down the circuit. Additionally, generators usually have a manual breaker/transfer switch to control the connection of electricity to the installed circuit of the office or compound.

Generators should also have an emergency stop button, in case of fire, catastrophic mechanical failures, or other issues. An emergency stop button should be clearly marked. Generators with acoustic canopy should be equipped with an emergency stop push button outside the canopy.

## **Generator Set Up**

### **Generator Room/Storage Area**

Generators generally require a specific place to be domiciled. Unless a generator is specifically designed for mobile applications, generally they do not usually move. A generator's location has an impact on its functioning and lifespan, and needs to be well planned.

Some generators can be extremely heavy and bulky, and often their location around an office or compound will depend on the ability for mechanical equipment or vehicles to load/offload the full-sized generator.

Generators should be installed on a flat, even surface. Unlike vehicles, generators are not designed to operate on slants or while tilted. A slight slant or grade may cause generators to move slightly over time with vibration or exposure to the elements, which can damage structures and equipment, or make servicing equipment difficult. If a heavy generator moves in an enclosed space with a built-up structure around it, moving by hand may be impossible.

The foundation of wherever a generator is housed should be sufficient to support the generator weight and be electrically neutral. Generators can be extremely heavy, and over time can break down or degrade poor foundations, or even shift in their orientation. Additionally, the vibrations of a running generator can greatly speed up degradation of the foundation or storage area, especially if the generator is not securely fashioned in place – the vibration works

like weak but constant jack-hammer.

It is good practice to install some kind of shock absorber to reduce generator vibrations, such as timber or rubber pieces. This helps reduce vibration by slightly raising the equipment, and also help control heat while making the unit easier to inspect and identify leaks.

Depending on the layout of the required operating space, generators may be installed in stand-alone rooms, be housed in some sort of open-sided generator shed, or may be exposed to air. Ideally, generators will have at least a roof or other form of covering above them to protect from rain, snow or excessive direct sunlight, all of which can impact the operation of a generator. Due the size and weight of generators, the shed or room may have to be built after the generator has been delivered, offloaded, and installed.

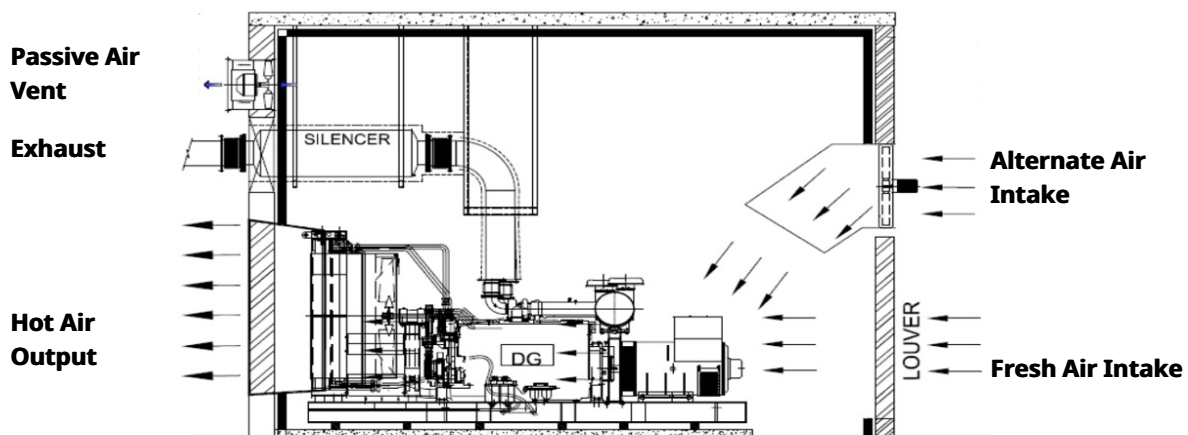

The room or storage area must cover several purposes; isolate the generator to decrease the noise and environmental impact on its surroundings, and preventing non-authorized access from staff, visitors, animals, or others. Even if a generator is relatively exposed, such as a covered awning with no walls, it is still advisable to have some sort of access control to the physical generator. The generator's storage areas may require additional physical built up walls on one or more side of the generator to block noise and prevailing winds.

Although construction materials can vary, the orientation must be planned carefully, taking advantage of the wind currents and minimising the noise and heat disturbances. A generator space should always be well ventilated, including the use of soffit vents or entirely exposed walls. If a generator is in a tightly enclosed space, specially made air outlet ducts are required. Ensure all outlets don't discharge into areas where humans and animals work or access frequently. If no other option is available than to ventilate into areas where humans and animals access, then all discharge points should be at least two meters from said spaces and be well marked.

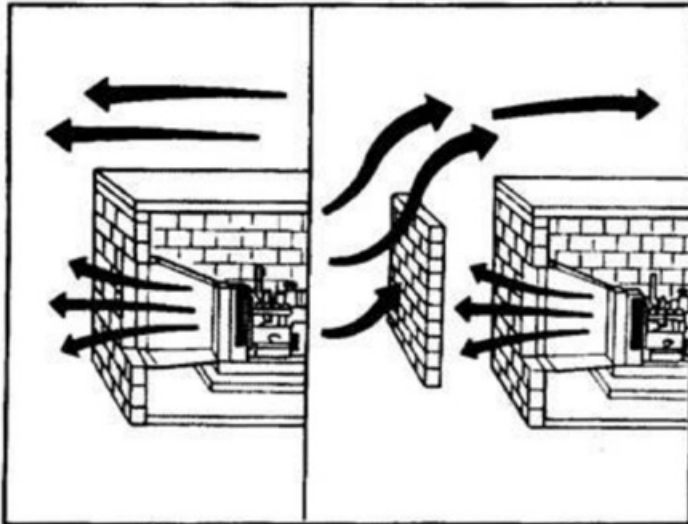

Wherever possible, position fuel or other dangerous goods so that the prevailing wind do not enter into the radiator/exhaust outlet. If this is not possible, install a wind barrier.

## Running a Generator

While there are general rules and best practices when running a generator, the best source of information is always the user manual for the accompanying machine, which provides full details about its usage and maintenance. Guidance coming from the manufacturer must always be followed.

In general, proper management of a generator starts by having an accurate and up to date monitoring system. Monitoring is crucial for performing analysis, identify potential failures and misuses, and informing future repairs and decision making. It is important to maintain records at least on:

- Running hours.
- Refuelling.
- Maintenance performed.

A simple but complete logbook should be used. A logbook should be kept near the generator, and all persons managing the generator should be trained and sensitised in its correct use.

Even though PRP generator types are rated for “unlimited” usage, this does not mean generators can run for an unlimited continuous time. Generators are still machines, which suffer from degradation and can overheat or break down. The continuous operation of generators may vary from machine to machine, but generally speaking the generators that humanitarian agencies obtain in field contexts are not designed to operate for more than 8 to 12 hours of continuous use at one single time. Running a generator for longer than an 8 to 12 hour period can dramatically shorten the life of a generator and lead to a higher frequency of break downs.

Generators usually must be switched off for a cool down period, which is why many agencies will install two primary generators in a compound or office. The two generators are generally installed near each other if not in the same storage room, and are both connected to the main electrical circuit of the facility. If two generators are installed in tandem, there should be a large external transfer switch to route power coming from either one or the other generator at one time. A no point should both generators be able to supply an electrical current to the same

closed circuit at the same time – this could cause catastrophic damage to facilities and equipment.

The use of two generators can be planned according to needs – either both generators should have identical power supplying capability, or the secondary generator is used for hours when load requirements are less. Solar power and other backup power supplies can also be connected to the external transfer switch. Usually, the act of switching between generators includes starting the incoming generator while the outgoing is still running. This will allow the incoming generator to warm up. It will also allow the main transfer switch to move between generators while power is being supplied, to minimise disruption to offices or living quarters.

## **Starting and Stopping a Generator**

Generators above a certain size and made for medium to long term usage generally have an internal switch used to connect or disconnect the unit from the main installed circuit of the office or compound. If the generator switch is set so that the generator is not connected, the motor will still run and the alternator will still produce electricity, however the main circuit will not be able to receive an electrical current.

### **Generators must never be started or stopped while connected to the installation, also called “loaded”**

When a generator turns on, there may be spikes or stalls to the power produced, due to air in the fuel lines, debris or other normal parts of the start-up process. These surges in power can exceed the load rating of any given installation and can damage equipment if not properly protected. It is a good practice to have a poster or leaflet in the language of the persons operating the generator explaining the process to start and stop the equipment that includes photos of the main parts to touch and the actions to be taken.

Standard starting procedure:

1. Make sure that the generator circuit breaker is open (if the generator does not have a circuit breaker: make sure that the installation main breaker is open).
2. Check the oil level.
3. Check the fuel level.
4. Check the water level (for water-cooled generators only).
5. Make sure that there is no leakage (no oil or fuel under the generator).
6. Start the generator.
7. Wait 2 minutes.
8. Close the circuit to the main circuit of the office or compound.
9. Record time of start on the associated logbook.

Standard stopping procedure:

1. Warn users that the power will be cut.
2. Open the generator circuit breaker (if the generator does not have a circuit breaker: open the installation main breaker).
3. Wait 2 minutes and.
4. Stop the generator.
5. Record time of stoppage on the associated logbook.
6. Refuel if necessary.

## **Care & Maintenance**

A generator must be regularly maintained to ensure it provides quality power throughout its life. Routine maintenance is relatively straight forward - there are general guidelines on what and when services are needed to prevent failures or enhance the equipment functioning.

While generator maintenance best practice is following the manufacturer's maintenance and schedule, the following controls and operations can be applied as a close approximation, especially if the manufacturer guidelines are unknown.

MAINTENANCE OPERATION	MAINTENANCE FREQUENCY				
	Daily or every 8 hours	Every Month	Every 150 hours	Every 250 hours	Every 500 hours
General Inspection	✓				
Check Engine Oil & Fuel Level	✓				
Clean and Check Battery		✓			
Check Grounding connection		✓			
Clean Spark Arrester			✓		
Clean Fuel Filters			✓		
Drain fuel Tank			✓		
Change Engine Oil				✓	
Replace Air & Fuel Filter Element				✓	



## MAINTENANCE FREQUENCY

MAINTENANCE OPERATION	MAINTENANCE FREQUENCY				
	Daily or every 8 hours	Every Month	Every 150 hours	Every 250 hours	Every 500 hours
Clean Engine Cooling Fins				✓	
Replace Spark Plug(s)					✓
Check fuel injection nozzle					✓
Replace Fuel Filter					✓
Adjust Valve Lash					✓

Service hours are tracked in "running hours," meaning only the hours while the generator is actually on and supplying power. Note that even if running a generator for an average of 12 hours, reaching 250 or 500 hours of total running time can occur extremely quickly, meaning the service intervals for generators can be quite frequent. Small investments made in replacing components and maintaining generators on a regular basis can save expensive and unnecessary upgrades or even replacement of the entire unit in the future.

When performing routine maintenance, each action taken should be logged, as well as the readings and parameters recorded along with the date of inspection and the hour meter reading. These sets of readings are compared with the next set of data collected. Any considerable variation of reading may indicate faulty performance of the unit.

Preventative maintenance thus ensures that the organisation has an uninterrupted power supply for all their needs. If a generator is rarely used, it is essential to start it at least once a week to keep it in good condition.

	<b>Intensive Usage</b>	<b>Occasional Usage</b>
<b>Starting generator</b>	As often as required	At least once a week
<b>150 hours maintenance</b>	Every month	Every 4 months
<b>250 hours maintenance</b>	Every 3 month	Every year
<b>500 hours maintenance</b>	Every 6 months	Every 2 years

## Corrective Maintenance

In some programs or sites of operation, it makes sense to have a trained repair technician permanently as part of the team. In most cases, is recommended to identify and establish a long-term agreement or other form of service contract with a trusted provider. Service providers should be in charge of the main maintenance and be ready in case of breakdowns. Important criteria when selecting a third-party provider is their ability to supply spare parts for the required equipment. If a third-party provider cannot supply spare parts, then organisations will need to maintain a stock of their own spare parts.

A generator set is the combination of an engine and an alternator plus wiring, controls, protections and connections. These are the components that need to be checked when looking for a failure.

There are four types of possible generator malfunctions:

- The engine does not start.
- The engine starts, but it stalls or misses.
- The engines works but starts overheating after a while.
- The engine runs smoothly, but the electricity is not properly generated.

It is recommended to refer to the user manual for specific fault-finding instructions as designs vary between manufacturers. Unless a problem is immediately identifiable, a professional generator technician or a qualified electrician may be required.

## Safety Considerations

- A generator must never be operated in a room continually occupied by persons or animals.
- A generator room must be correctly ventilated.
- Fuel and oil must not be stored in the generator room.

- A fire extinguisher rated for electric and fuel fires (preferably a CO2 fire extinguisher) must be available outside the generator room. Fire sand bucket can be an option when extinguishers are not available or as a backup.
- All generator must be properly grounded. Usually, generators come with a grounding bolt in the frame marked with the ground symbol, to which ground cables should be attached. If there is no evident bolt, the ground line can directly be connected to the metallic frame of the generator.

## Battery System

A battery system leverages chemical reactions to store electricity for later use, be it electricity from a generator or public. In technical terms the electricity itself cannot actually be stored, but the relative energy equivalent is stored as potential energy through chemical reaction, and can be transformed into electricity later. Chemical batteries work by charging a solution that retains the charge long enough to be discharged again and distributed later.

## System Architecture

Batteries are finite storage mediums and operate in relatively simple ways.

Batteries can only receive and supply DC currents, while most large electrical appliances and power sources use AC currents. To accommodate this, batteries require external devices to convert currents based on usage and need.

- To receive an AC current the battery will need a transformer or specialised battery charger.
- To deliver an AC current, the battery will need an external inverter.

These 2 devices are often combined into an inverter-charger which can be used as an intermediary between the battery and the closed circuit.

As each battery has a limited capacity, battery power supplies require special equipment to monitor and control the flow of electricity entering a battery, called a charge controller. A charge controller will continuously monitor the charge state of a battery – recognising how “full” it is – and should automatically terminate charging once a battery is full. Batteries are highly energetic and can be extremely dangerous if over charged! An overcharged battery can spark, start fires, and even explode, possibly throwing hazardous chemicals while it does. No battery power backup should be attempted without a proper charge controller in place.

Just like a generator installation, a battery power backup should also have all available protections in place, including breakers, fuses, and a grounding cable.

Thus, a battery system usually includes:

- One or more batteries.
- Inverter-charger.
- Charge controller.
- Cabling and protective devices such as fuses and grounding.

## Batteries

A battery is a storage device capable of storing chemical energy and converting it into electrical energy through electrochemical reaction. There are many different types of

chemistry that are used, such as nickel-cadmium batteries used to power small portable devices or Lithium-ion (Li-ion) batteries used for larger portable devices. The most proven type of chemistry and the longest used however is the lead acid battery.

## Types

Batteries are made with several materials and shapes suitable for different purposes. This guide will focus on the most common batteries used as a back-up for power generation sources. The two main types can be summarised as:

1. Flooded Batteries.
2. Valve Regulated Lead Acid Batteries.

### Flooded Batteries:

Flooded cell batteries are the most common conventional battery used in internal combustion vehicles. Flooded cell batteries are referred to in several ways:

- Flooded Battery.
- Wet Cell Battery.
- Spillable Lead Acid Battery.
- Resealable Lead Acid Battery.

These batteries contain a combination of a liquid electrolyte that is free to move in the cell compartment. Users have access to the individual cells and can add distilled water (or acid) as the battery dries out. The main characteristic of this kind of battery is their low cost, which makes them available almost everywhere in the world and widely used in low income or developing economies. Handling flooded batteries are quite easy, and they can be charged with a simple unregulated charger. However, these batteries require periodic inspection and maintenance, and extreme climates can have a greater effect on battery lives due to the electrolyte solution inside the battery having the ability to evaporate or freeze.

These batteries are commonly made with two terminals and 6 caps allowing access to each 2V compartment or cell, giving 12V in total. For this type of battery, the typical absorption voltage range is 14.4 to 14.9 volts and a typical float voltage range 13.1 to 13.4 volts.

**Car or truck batteries are not suitable to be the permanent system for storage** Vehicle batteries are designed to provide high current during short periods, specifically to start a combustion engine. There are lead-acid batteries that are specifically designed recently for storage applications.

### VRLA (Valve Regulated Lead Acid) Batteries:

Valve Regulated Lead Acid (VRLA) battery is a term that can refer to a number of different makes and designs, but all share the same property - they are sealed. VRLA batteries are sometimes referred to as sealed or non-spillable lead acid batteries. The sealed nature of the batteries make transport easier and less dangerous, and may even be transported via aircraft under certain circumstances. Being sealed however reduces their lifespan as they cannot be refilled - on average their life span is 5-years at 20°C.

VRLA batteries are usually more expensive and require a fully regulated charger, which makes them less common throughout the world. These batteries may still use lead acid as a chemical solution, but they may use threaded pins instead of chambers and terminals.

The namesake of the battery comes from a valve regulating mechanism that allows a safe

escape of hydrogen and oxygen gasses during charging. There are also more advanced designs, including:

**Absorbed Glass Mat (AGM) Batteries** The AGM construction allows the electrolyte to be suspended in close proximity with the plate's active material. This enhances both the discharge and recharge efficiency. Since there is no liquid inside, these batteries can perform better than flooded batteries in applications where maintenance is difficult to perform, however they are sensitive to over or under charging affecting their life and performance. AGM batteries perform most reliably when their use is limited to the discharge of no more than 50% of battery capacity. AGM batteries are usually the type of batteries selected in off-grid power systems.

**Gel Cell Batteries** Gel cell batteries have a water-acid in gel form. The electrolyte in a gel cell battery has a silica additive that causes it to set up or stiffen. The recharge voltages on this type of cell are lower than the other styles of lead acid batteries, and gel cells are probably the most sensitive cell in terms of adverse reactions to over-voltage charging. Gel batteries are best used in very-deep cycle applications and may last a bit longer in hot weather. Unfortunately a total deep discharge will irreversibly destroy the battery. If the incorrect battery charger is used on a gel cell battery, poor performance and premature failure is certain. Note: It is very common for individuals to use the term gel cell when referring to sealed, maintenance-free batteries, much like one would use a brand name when referring to an entire product category. Be very careful when specifying a charger - more often than not, when someone is referring to a gel cell they really mean sealed, maintenance-free VRLA or AGM-style battery. Gel cell batteries are not as common as AGM batteries, and would be hard to source in humanitarian contexts.

Battery Type	Absorption Voltage Range	Float Voltage Range
<b>Flooded Batteries</b>	14.4 to 14.9 volts	13.1 to 13.4 volts.
<b>VRLA Batteries</b>	14.2 to 14.5 volts	13.2 to 13.5 volts.
<b>AGM Batteries</b>	14.4 to 15.0 volts	13.2 to 13.8 volts.
<b>GEL Batteries</b>	14.0 to 14.2 volts	13.1 to 13.3 volts.

## Capacity

Capacity is defined as the total amount of energy a battery can store and reproduce in the form of electricity. Battery capacity is usually described in multiples and orders of magnitude of Watt-hours (Wh) – 1 Wh to one 1 kWh (1,000 Watt-hours). A Watt-hour is defined as the

electrical energy required to supply a Watt of electricity for one continuous hour. For example, a standard 60W incandescent bulb would require 60Wh of stored energy to function for one hour. It is easy to see why properly estimating consumption needs are important for designing battery back-up systems, especially for security or mission critical related items.

Probably the most important specification of a battery is its capacity rated in Amp-hours (Ah). Determining Wh is done when Ah are combined with battery voltage - often 12 volts.

Energy (Wh) = voltage (V) × capacity (Ah)

A battery capacity depends on:

- **Discharge Duration:** Usually manufacturer indicated capacity at 20hrs, noted as C20. For a C20 batter, the same battery will be able to deliver more energy in 20 hours than in 10.
- **Temperature:** Capacity can increase or decrease with external temperature. Rating is benchmarked at 20°C.

Also keep in mind that cycling a battery through its full capacity will likely damage it if done repeatedly. To increase battery lifespan, there should always be some energy left in it before recharging. For this reason, usually only 50% of the capacity is used. As a result, the energy a battery can actually deliver is better measured by looking at half its full capacity.

Energy = 0.5 × voltage × capacity

A 100Ah battery contains 1,200Wh:

$$100 \times 12 = 1,200\text{Wh}$$

**Example:** To increase its lifespan only 600Wh can be used. How long would a 40W light bulb last in continuous use?:

$$600\text{Wh} / 40\text{W} = 15 \text{ hours}$$

A 40W light bulb could run for **15 hours** before the battery needed to be recharged.

---

As a rule of thumb, the larger the battery and the higher the capacity, the more efficiency increases while the price per watt-hour decreases. It is recommended to use the battery type with the highest capacity available, and then work off multiples of that battery type to reach the overall energy storage needs. Continually adding smaller, lower capacity batteries will lead to higher costs and more problems later on.

## Float Life

Float life is the expected service life of a battery if undergoes continuous charge, and is never discharged. When a battery is installed in an electrical system that constantly receive a charge, it is called "float charging." If power is cut and float charged batteries are switched to, the "float life" indicates how long these batteries can last. Float life decreases with temperature and manufacturer float life is usually rated at 20°C. As a general rule, float life will reduce by approximately half for every average temperature increase of 10°C.

A battery with a rated float life of 10 years at 20°C. How long will it last if the average temperature is 30°C?

**Example:**  $10 / 2 = 5$  Years

It will last **5 years** if the average temperature of the battery room is 30°C and only **2.5 years** if the average temperature of the battery room reaches 40°C.

---

## Cycle Life

In addition to float life, "cycle life" is the number of cycles that the battery can withstand during its service life. A battery cycle is defined as a battery being fully charged and then fully discharge, making one full "cycle." It is common to have this information in technical specifications, and it is recommended to buy batteries with a cycle life of more than 400 cycles.

Cycle life depends on the depth of discharge. A 50% depth of discharge is a good compromise between over-investment and quicker degradation.

## Other Specifications

The other characteristics of a battery are:

- **Self-Discharge Rate:** Self-discharge rate is defined as how quickly a battery will dissipate electricity if stored full but unused. Useful only if the batteries are intended to be stored for long duration. A lead-acid battery self-discharge rate is generally below 5% a month.
- **Freezing Point:** A battery will be destroyed if its electrolyte solution freezes. The freezing temperature depends on its construction, composition, and rate of charge, and a discharged battery freezes more easily. A battery freezing point is almost always below that of water, however.

## Number of Batteries Needed

The type of battery required for an installation will depend on the power needs, the budget, in the country of operations, and the conditions under which they system has to perform.

Once the battery model has been identified, the number of batteries required must be calculated. This can be done with the following formula, always rounding the number up.

Number of batteries = (Energy consumption) / (max cycle depth × Battery voltage × Battery capacity)

A system analysis indicates a need for 12,880Wh. The available batteries are 220Ah / 12V, and require a 50% maximum depth of discharge. How many batteries are required?

**Example:**  $12880 / (50\% \times 12 \times 220) = 9.76$

**10 batteries** are required.

---

Note that all the batteries used in a battery system must be exactly the same:

- **Same Capacity:** if 500Ah are needed it is not possible to use 2 x 200Ah + 1 x 100Ah. The system would require 5 x 100Ah or (preferably) 3 x 200Ah.
- **Brand and Model:** As much as possible, batteries should be the same brand and model.
- **Age:** As far as possible, all batteries should have the same "history". It is strongly recommended to not mix old and new batteries, even if they are the same model.

## Inverter-Charger

While it is important to select batteries that have the correct storage capacity and design, inverter-charger devices can increase the efficiency of the system. Equally, an inverter-charger can damage a system if it is installed incorrectly, or if it is malfunctioning or poorly designed. The purpose of an inverter-charger is to transform current from AC to DC to charge batteries, and from DC to AC to discharge batteries. Inverter-chargers can do much more however – they can function as the "brain" of the electrical installation, coordinating the energy flows between the main source (generator or grid), batteries, and the end user. A proper inverter-charger can provide a far better quality of service than any other back-up systems, including:

- Power available from the inverter can be as high as 4 times the maximum power of the main power supply.
- Increased generator lifespan.
- Regulated voltage and frequency.
- Uninterrupted power supply.

Inverter-chargers should be purchased along with:

- Battery controllers.
- Temperature sensors.

## Battery Cable Connections

The cables that join batteries together play an important part in the performance of the battery system. Choosing the correct size (diameter) and length of cable is important for overall system efficiency. Cables that are too small or unnecessarily long will result in power loss and increased resistance. When connecting batteries, the cables between each battery should be of equal length to ensure the same amount of cable resistance, allowing all batteries in the system working equally together.

Particular attention should also be paid to where the main system cables that are connected to the battery bank. All too often the system cables supplying the loads are connected to the first



or “easiest” battery to get to, resulting in poor performance and service life reduction. These main system cables that run to the DC distribution (loads) should be connected across the whole battery bank. This ensures the whole battery bank is charged and discharged equally, providing optimal performance. The main system cables and the cables joining the batteries together should be of sufficient size (diameter) to handle the total system current. If there is a large battery charger or inverter it is important to be sure that the cables are capable of carrying the potentially large currents that are generated or consumed by the connected equipment, as well as all the other loads.

## Installing a Battery System

### Battery Room

A battery room has the same purpose as a generator room:

- Isolate the battery system to decrease the risk of accident - such as acid leakage or harmful gas emissions - and prevent non-authorized access.
- Ensure good operating conditions: a battery room must protect electronics against water and dust, and be well ventilated.

Batteries used for power back up and distribution need a specific place to be located, and must be well planned. It is convenient to have the battery room close to the main power supply or the distribution board, however the batteries must not be installed in the same room as the generator. High or fluctuating temperatures considerably affect the service life and batteries performance, and it is recommended to have a separate well ventilated battery room with a temperature as close as possible to 20°C. A dry and ventilated a cellar or underground room is a perfect location, provided the underground storage location will not flood or collapse.

Under no circumstances should battery storage locations be located in living or working spaces. A fully charged battery is highly energetic, and can spark, give off fumes, combust, or even explode. A faulty charger or an overcharged battery may display signs of distress, including swelling and smoking. However, an overcharged battery may also display no signs and provide no warning. A ruptured battery can propel shrapnel and throw very toxic chemicals, while the fumes may be extremely harmful or even lethal if breathed. If a battery shows any signs of warping, distress or overheating, the entire system should be shut off, and the battery should be disconnected when safe to do so. Do not attempt to reuse damaged batteries – they should be disposed of safely, and in accordance with local laws and regulations.

### Installation Sizing

To size a battery system, the following will need to be determined:

- The maximum power the inverter has to be able to deliver to the installation.
- The amount of energy that must be stored in the battery to cover your needs.
- In some case, the power the charger can deliver to the batteries.

Please reference the section on [energy management](#) on how to calculate the power and energy the system has to deliver.

To manually calculate the maximum power of the installation:

1. List all electric appliances fed by the installation.
2. Find the maximum power of each electrical appliance. For appliances including an

electrical motor the maximum power is approximately three times the nominal power. For example, a 300W water pump will need around 1kW to start.

3. Add all power together.

To manually calculate the energy consumption of the installation:

1. List all electric appliances fed by the installation and their nominal average power.
2. For each appliance determine how long should be in use. The assumed energy needed for each appliance can be calculated by: average power x duration.
3. Add all energy requirements together.

Take into consideration the hours that the battery system is intended to deliver electricity and plan accordingly. A battery configuration won't be the same if the system will deliver power only during night or be used as a full day twenty-four-hour backup. If it is possible, plan to run a generator during peak energy consumption hours, decreasing the number of batteries required and reducing the full cost of the system.

The power of the battery charger will determine how long recharging will take. A high-power charger that can charge batteries rapidly is useful if the main power supply is very expensive – a big generator with high consumption - or if the electricity from the main power supply is only available during short duration - public grid available only few hours per day.

To be able to charge the batteries in a fixed duration, the formula to use is:

Power=Energy consumption / charge duration

An installation has an estimated energy consumption of 12,880Wh, and needs to reach a full charge in 6 hours. What Wattage must the charger be?:

**Example:**  $12,880 / 6 = 2,150W$

The charge power must be at least **2,150W**.

---

Charger power is often rated in current (Amps) rather than in power (W). To calculate charge current from the charge power simply divide the charge power by the charger voltage (usually 12, 24 or 48V).

- If 12V charger is used, the charge current must be:  $2,150 / 12 = 180A$ .
- If 48V charger is used, the charge current must be:  $2,150 / 48 = 45A$ .

Additional considerations:

- The minimum duration to charge battery is 4 hours. Faster charging may damage batteries, and some batteries may have limitations longer than 4 hours.
- Even with a powerful battery charger, the charge may be longer due to the limited power available from the main power supply - with 5kW generator, buying a 10kW charger is pointless.
- For chargers that have advanced settings, the charge algorithm may extend charge duration to save battery life. Some chargers automatically decreases the charge power when the battery is close to 100%.

## Connecting Batteries

There are several ways to wire multiple batteries to achieve the correct battery voltage or capacity for a particular DC installation. Wiring multiple batteries together as one big bank, rather than having individual banks makes them more efficient and ensures maximum service life.

### Series Connection



Wiring batteries together in series will increase the voltage while keeping the amp hour capacity the same. In this configuration, batteries are coupled in series to gain higher voltage, for instance 24 or even 48 Volt. The positive pole of each battery is connected to the negative pole of the following one, with the negative pole of the first battery and the positive pole of the last battery connected to the system.

For example; 2 x 6V 150Ah batteries wired in series will give 12V, but only 150Ah capacity. 2 x 12V 150Ah batteries wired in series will give 24V, but still only 150Ah.

---

### Parallel Connection



Wiring batteries together in parallel has the effect of doubling capacity while keeping the voltage the same. Parallel coupling involves connecting the positive poles and negative poles of multiple batteries to each other. The positive of the first battery and the negative of the last battery are then connected to the system.

For example; 2 x 12V 150Ah batteries wired in parallel will give only 12V, but increases capacity to 300Ah.

---

### Series/Parallel Connection



A series/parallel connection combines the above methods and is used for 2V, 6V or 12V batteries to achieve both a higher system voltage and capacity. A parallel connection is required if increased capacity is needed. The battery should then be cross-wired to the system using the positive pole of the first and the negative pole of the last battery.

For example; 4 x 6V 150Ah batteries wired in series/parallel will give 12V at 300Ah. 4 x 12V 150Ah batteries can be wired in series /parallel to give you 24V with 300Ah capacity.

---

## Solar Systems

### Sunlight and the Photovoltaic Effect

The photovoltaic effect is the process of using sunlight to produce DC electricity in a silent, clean, and autonomous way. The equipment required to produce this electricity is commonly called a "solar panel," and are modular and require minimum maintenance. Combined with their long durability solar systems are increasing in popularity in remote areas or when an installation is expected to last.

Solar panels are devices able to transform light radiation into electricity through a process of trapping the photons and using them to excite P-type and N-Type semiconductors to move free electrons. Modern photovoltaic panels can generally convert around 15-20% of energy directly into electricity. There are panels that are more efficient, but they are very costly, easy to

damage, and are generally not accessible in places where humanitarian organisations might work.

Light enters the device through an anti-reflective coating that minimises the loss of light by reflection. The device then effectively traps the light striking the solar cell by promoting its transmission to the three energy-conversion layers below.

- N-Type Silicon layer; Provides extra electrons (negative).
- P-N junction layer. The absorption layer, which constitutes the core of the device orienting the electrons in one direction.
- P-Type Silicon layer; Creates vacancy of electrons (positive).

Two additional electrical contact layers are needed to carry the electric current out to an external load and back into the cell, thus completing an electric circuit.

Most solar cells are a few square centimetres in area and are protected from the environment by a thin coating of glass or transparent plastic. Because a typical 10cm×10cm (4 inch × 4 inch) solar cell generates only about two Watts of electrical power, cells are usually combined in series to boost the voltage or in parallel to increase the current. A solar, or photovoltaic (PV), module generally consists of 36 or more interconnected cells laminated to glass within an aluminium frame.

One or more of these PV modules may be wired and framed together to form a solar panel, and multiple panels can be combined to form a solar array, together supplying power as a single unit.

#### A Full PV System Would have...

- Electricity Meter
- AC Isolator
- Fuse Box
- Inverter
- Battery
- Charge Controller
- Cabling
- Mounting
- Tracking System

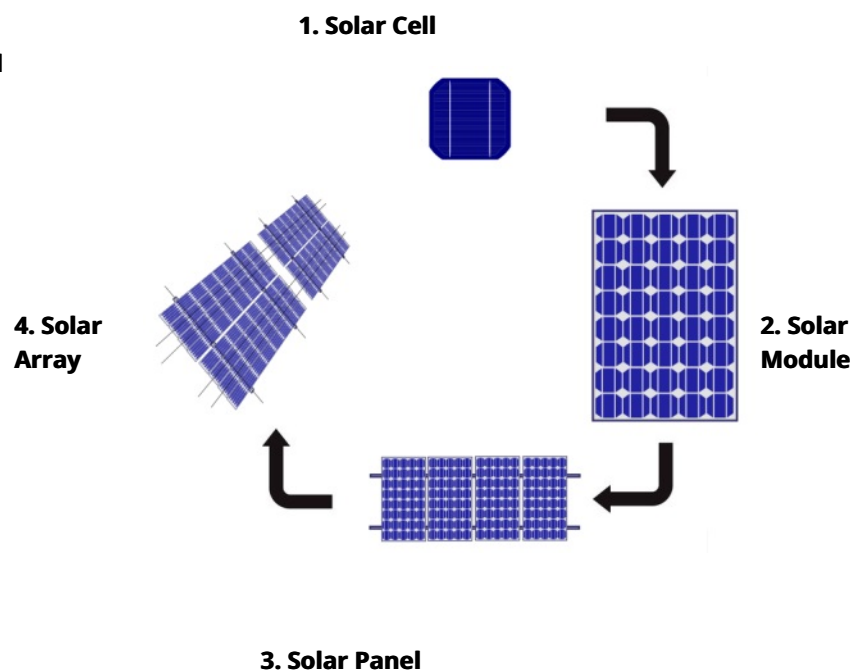

## Solar Cell Degradation

All solar cells - and by extension solar panels - degrade over time. While solar systems draw energy from the sun, the sun also slowly breaks down the components of solar cells. Most commercially available solar panels degrade at an average rate of 2% per year of usage. The duration of use of an installation must be factored for planning and budgeting purposes. For example, a solar array installed in direct sunlight degrading at 2% a year means that after 10

years, the panels will only be roughly 80% as efficient as they were at the time of installation. Less efficiency means less Wattage output from the array, meaning longer periods of time to charge batteries and less optimal charging times throughout the day. Humanitarian agencies planning to use solar arrays longer than 10 years in a single location may want to consider budgeting for the replacement of panels after 12-15 years if the overall output is no longer meeting the needs of the location.

## System Architecture

A complete photovoltaic system may consist of one solar module or many, depending on the power needed. While batteries can be used as back-up of any main power supply, solar systems need a battery system to store the energy produced. Therefore, a solar system always includes some form of battery system, either small or big. These batteries are specifically designed to deliver limited current over long period of time.

A power system can accommodate different electrical loads by regulating the voltage and/or current coming from the solar panels going to the battery to prevent overcharging. Most "12 volt" panels can put out about 16 to 20 volts in optimal conditions, so if there is no regulation the batteries can and will be damaged from overcharging. Most batteries need around 14 to 14.5 volts to become fully charged. Like any other electrical system, proper assessment and cabling are required.

A solar system is usually composed by:

- PV module, solar panel or array, including its multiple types of mounts.
- A battery system.
- A solar regulator.
- Cabling and protections.

Solar systems can accommodate almost any specific need because they are modular in nature. This makes it possible connect PV modules directly do many devices, such as submersible pumps or standalone freezer units, or as a complete solar power arrays able to produce energy for entire offices or compounds.

## Solar Modules

Solar modules are rated in Watt-peak, represented as nominal peak power ( $P_{max}$ ), derived from multiplying peak power voltage ( $V_{mp}$ ) with its peak power current ( $I_{mp}$ ):

$$P_{max} = V_{mp} \times I_{mp}$$

A 100Wp solar panel produces 100W under standard test conditions (STC). The STC exist only in laboratories, applying a solar irradiance to panels of 1,000W/m<sup>2</sup> with a cell temperature of 25°C. In a real installation, the actual production of electricity is usually far lower than the peak-power, however the measures remain useful as qualitative reference to compare sizes and capacities as every panel is rated under the same conditions.

## Example Label that Comes with Solar Panel

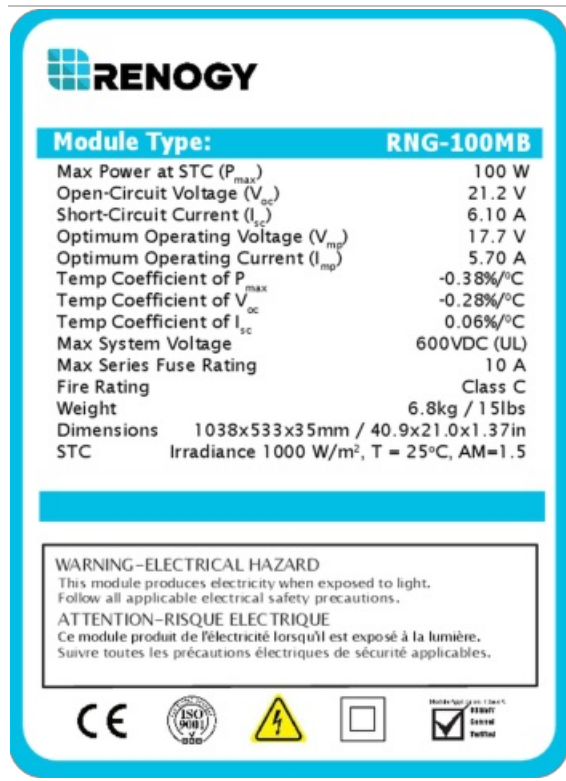

The amount of electrical energy produced during a single by a solar module depends mainly on:

**Daily Irradiance:** The quantity of energy provided by the sun in one day is the most important parameter. Areas close to the equator have the best average irradiance, however this general rule may vary greatly from one place to the other and from one season to the other. The average performance of a PV system expressed in kWh/m<sup>2</sup>/day can be referenced in the chart below.

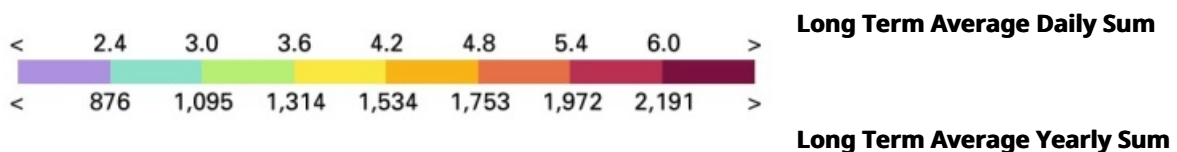

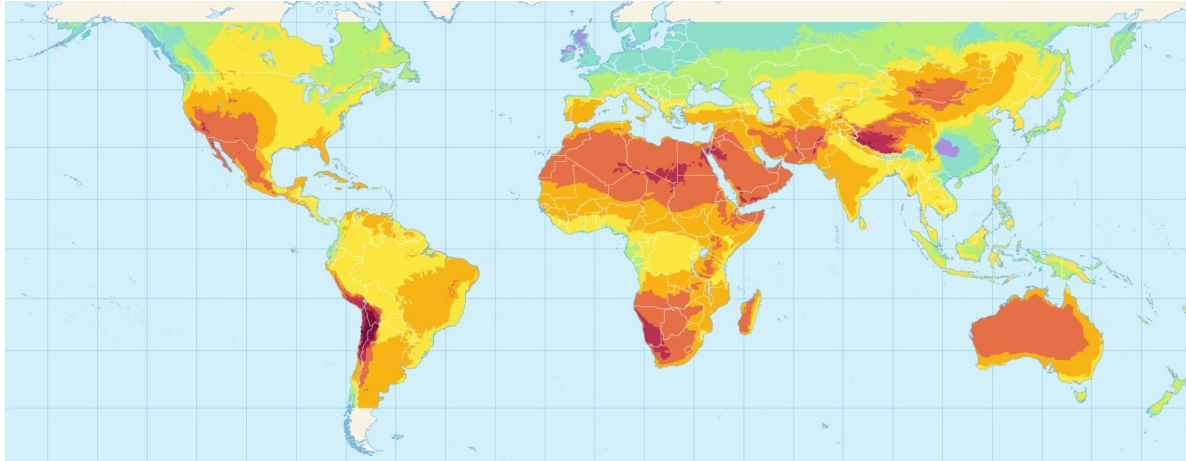

---

**Shade, haze, and cloudy weather:** any obstacle blocking sun light will decrease the energy production of the module. In addition, if a solar panel is partially shaded, the electricity production may stop as the shaded cells will consume the energy produced by the rest of the panel. In some cases, a phenomenon called “hot spot heating” occurs when the shaded portions of a single panel rapidly heat up as they consume electricity from an unshaded part, and can rapidly destroy the panel. This can be prevented by using by-pass diodes which are commonly included in PV modules, but it is highly recommended to check on this feature.

**Panel orientation:** a poorly oriented panel - for example facing the north in the northern hemisphere - will produce far less energy than the panel is rated for, or even no energy at all.

**Temperature:** Temperature above 25oC also can decrease the amount of energy produced by a solar panel.

**Daylight hours:** Solar panels produce more electricity when the vertical rays of sunlight are closer together, providing more energy per square cm. By result, solar panels will produce less electricity as the sun is near the horizon than it will when the sun is directly overhead. In practical terms, a solar panel near the equator that is outside for a 12 hour day will only produce the equivalent of 6 hours worth of peak electricity, and this is only under optimal conditions. Changes to the seasons or bad weather will drop this production even further.

As a result of the aforementioned factors, the actual production of electricity from a solar system can be difficult to evaluate. A simple method is to size the installation so that it produces 30% of the daily energy needs during the worst month.

### **Mounting Panels and Arrays**

WPV modules combined to create solar panels, and solar panels combined mounted together to create solar arrays are possible using standard junction boxes - MC3/MC4 type - that are waterproof and easy to connect. Like batteries, panel arrays should only use solar modules with the same characteristics, the same model, and as far as possible the same history.

### **Mounts**

Solar trackers - devices that orient panels towards the sun - are complex, expensive and not recommended outside of industrial uses and/or high latitudes where the sun moves considerably. Some mounts are designed to allow seasonal adjustment, giving the ability to switch manually between two positions during the year, which should be more than enough

for most installations.

There are essentially two types of solar mounts available: Ground and Roof mounts. Ground mounted solar panels are easier to install and maintain than roof mounted systems. Roof mounted systems are difficult or impossible to adjust and can cause structural damage due to weight and wind pressure. However, ground mounts have their own problems; they occupy usable space, are more prone shade, and run the risk of accidental damage from cars and people. Mounting decisions should be made depending on the location and infrastructure available.

## Battery Systems

Solar batteries are crucial to help keep solar systems running. Without battery storage, electricity will only be available while the solar panels are producing it. Since panels only produce energy during the day while consumption may occur at any time, a stable power bank is essential to store this energy. Please reference the [section about batteries](#) for more information.

## Solar Regulator

Charger controllers, commonly known as solar regulators are electronic units designed to control the current flow - both the current charging the batteries from the panels, and the current coming from the batteries to offices/compounds.

Solar regulators control the charge and discharge of batteries by disconnecting the panels when batteries are fully charged, and by cutting power to the load when the battery is too low. Another important function of solar regulators is to optimize energy production from the panels by converting the higher voltage output coming from the panels down to the lower input voltage needed by the batteries. The regulator functions as a hub of the installation, and obtaining maximum power output depends on its proper functioning.

There two kinds of solar regulators:

### Maximum Power Point Tracking (MPPT):



The MPPT detects the solar panel output voltage and current in real-time and continuously tracks the maximum power ( $P=U*I$ ), regulating the output voltage correspondingly so that the system can always charge the battery with the maximum power. This type of power tracking allows for better power production under cloud coverage and variant temperatures. While more expensive upfront, the MPPT Charge Controller will give more power (and potentially reduce the size of the PV module) and extend the lifespan of the batteries connected to it. Certain controllers even allow connection to smart devices for remote control and monitoring.

### Battery Charge Method

Multi-Stage MPPT



### Maximum Power Point Tracking (MPPT):

---

**Solar to Electric Conversion Rate** 99%

---

**Ampere Rate** 30A-100A

---

**Scalability/Range** >2KW Large power system

---

**Average Price** 120\$

---

#### Advantages

- Maximum power point tracking algorithm increases power conversion rate up to 99%.
  - 4 stage charging is better for batteries.
  - Scalable for large off-grid power system.
  - Available for solar systems up to 100 Amps.
  - Available for solar input up to 200V.
  - Offer flexibility when system growth required.
  - Equipped with multiple protection devices.
- 

#### Disadvantages

- High cost, usually twice a PWM.
  - Larger Size than a PWM regulator.
- 

### Pulse Width Modulation (PWM):



PWM charge controllers can be considered an electric switch between the solar panel and battery packs, programmed to only allow a pre-determined current into the battery. The controller slowly reduces the amount of power going into the battery as the batteries approach maximum capacity. PWM Charge Controllers do not adjust voltage, meaning the batteries and panels must have compatible voltages in order to operate properly. This makes this type of charge controller suitable for smaller solar applications, or for installations that feature lower voltage panels and limited size battery banks. PWMs are a more affordable option but will result in a lower power production from the PV.

---

**Battery Charge Method** 3 Stage PWM

---

### Pulse Width Modulation (PWM):

---

**Solar to Electric Conversion Rate** 75%-80%

---

**Ampere Rate** 20A-60A

---

**Scalability/Range** <2KW Small solar system

---

**Average Price** 65\$

---

**Advantages**

- PWM Regulators have a longer and proven history.
- PWM Regulators have simpler structure and are more cost-effective.
- Easily deployed.

---

**Disadvantages**

- Low conversion rate.
- Input voltage must match battery bank voltage.
- Less scalability for system growth.
- Lower output.
- Less protection.

---

## Panel Installation

The storage location of the solar array connected batteries should be identified before sizing and purchasing any equipment. Not only should the space be large enough to mount the required panels, the distance and cable length from the battery storage location will impact the calculated power requirements. Please reference the [section on battery installation](#).

A good location to install a solar array will have the following characteristics:

- Be inside a compound and not visible from the outside. Ground mounted solar panels ideally should be protected by a wall or fence, so sufficient ground space is important.
- Be as close as possible to the battery system.
- Be away from shade, such as trees or buildings.

Sometimes it is difficult to completely avoid shaded areas. The priority should be to avoid shade during the sunniest hours of the day (generally 10am to 16pm). Remember that the position and sizes of shadows change with the seasons.

### Solar Panel Position

To optimise energy production, solar panels must be carefully oriented to take full advantage of sunlight exposure. Solar panel pointing includes.

- **Orientation** - Orientation is the angle of the solar panel relative to the north-south axis. Solar panels must face the south in the northern hemisphere and the north in the

southern hemisphere.

- **Tilt** - Tilt is the angle of the solar panel relative to the horizontal plan. Tilt is more difficult to optimise. Latitude can be used as an approximation of the optimal tilt angle, as referenced in the guide below for panels with fixed angles. However, even on the equator panels should have a minimum tilt angle of 5 to 10° to avoid accumulation of water and dust on the panel.

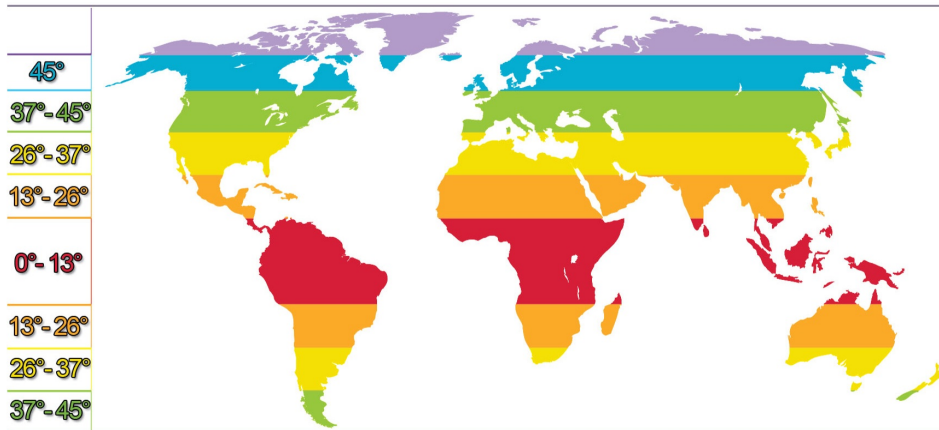

### Connection

The output of the solar panels is connected to the solar regulator, while the output of the solar regulator is connected to the batteries. The solar panel mounting frame is connected to the ground, and a grounding/earthing connection is highly recommended for the regulator and surge protector.

Depending on the power or energy required, panels can follow three different schemes that will give different power and current results. Modules connected in series, parallel, or a combination of both will give different power and energy outputs.

### Installation Sizing

#### PV Modules

Below is a simple method of sizing installations so that they produce 30% of the daily energy needs during the worst months of the year:

To cover 30% of the energy needs of an installation, how many solar panels will be needed for:

- A planned power need of 12,880Wh
- An annual average daily production is 4.32kWh per 1kWp
- During the worst month, an average daily production of 2.62kWh per 1kWp

The total actual power production needed per day is:

$$12.88 \times 0.3 = 3.87\text{kWh}$$

At an average daily production of 2.62kWh per 1kWp of module, the total daily need is:

**Example:**

$$3.87 / 2.62 = 1.48\text{kWp}$$

The actual number of solar panels required will depend on the peak-power of each individual panel. Possible configurations might be:

**12 x 130Wp panels**  
(1.56kWp)

or **9 x 180Wp panels**  
(1.62kWc)

or **6 x 260Wp panels**  
(1.56kWc)

---

As there is an annual average daily production is 4.32kWh per 1kWp, 1.48kWp installation will produce  $4.32 \times 1.48 = 6.39\text{kWh}$  per day in yearly average, adding to the overall increased energy costs savings.

---

## Regulator

The solar regulator must be sized according to the number and type of solar modules used. Regulator sizing includes:

- The voltage should be the highest possible according to the number of solar modules in the systems.
- Maximum current should be equal to the short-circuit current (ISC) of your solar array. Short circuit current for one individual panel can be found on the identification tag of the panel or in the manufacturer manual. To calculate the short-circuit current of an entire array, combine the short-circuit currents of all panels connected in parallel.

## Batteries

Information about Batteries sizing can be found in the section on [installing a battery system](#).

## Cables and Protection

Information about cable lengths and wire gauges can be found in the chapter [electrical installations](#).

## Safety and Security

Photovoltaic panels produce electricity just like a regular generator. Though the production method may be different, and depending on the size of the array the overall Wattage less than a generator, solar arrays can still produce harmful amounts of electricity.

### Handling

Whenever persons must handle a PV solar panels they must wear the proper [protective clothing](#) and equipment at all times.

More importantly - PV solar panels produce an electrical current, even when they are not connected to any other device! As long as a panel is partially exposed to light, it will be producing some form of current and can still pose a risk. A panel producing electricity will not make a noise or vibrate, and may not even be warm to the touch. Usually PV solar panels have no form of indicator that they are producing electricity at all. For this reason, PV solar panels tend to look safe to the touch, even when they may not be.

When installing, removing, or simply adjusting solar panels, they should be completely covered. If possible, work can also be done at night time. When carrying or handling solar panels, handlers should note all electrical connector outputs on the side, avoiding making accidental contact with them. Consider all wires coming from a solar panel the same as a live wire coming from a powered grid or live generator.

### Security

PV Solar panels should always be in a secure location, just like generators and batteries. The orientation of buildings and vegetation may make this a difficult task, but planners should consider access control.

- If possible, install panels on roofs of buildings, and in areas where persons do not frequently visit - avoid roof top terraces or resting areas.
- Install solar arrays inside of compound spaces, inside the safety of a perimeter wall wherever possible. Even if arrays are inside a compound wall, there should be some form of signage and barrier fencing to prevent visitors or casual labour from accessing the area.
- If solar arrays are installed in the open or in remote locations, then a separate security fence or wall will need to be built around the outside. The equipment is expensive, but it can also harm humans and animals passing by. Persons unfamiliar with solar panels may be drawn close out of curiosity, so signage must be posted in the appropriate local language.

## Energy Consumption Calculator

### Energy Demand

#### General Data

Country	<input type="text" value="-- select --"/>
Temperature	<input type="text"/> °C
Altitude	<input type="text"/> m

### General Data

Solar daily irradiance  kWh/m<sup>2</sup>/day

### Calculation Settings

Local rated voltage n/a Vca  
Local frequency n/a Hz  
There is any 3-phase Consumer in the installation?   
The installation provides power to a hospital (very sensitive structure)?

Appliance/Device	Quantity	P (W)	S Max (VA)	S Avg (VA)	Working Hours				E
					Morning	Midday	Afternoon	Evening	
<input type="button" value="Add row"/>	<input type="button" value="Remove last"/>	<input type="button" value="Reset"/>							

- General
- Generator
- Battery
- Solar

### Estimation of Needs

#### Energy Consumption per Day

Total n/a W a day  
Low consumption devices (Class 1) n/a W a day  
High consumption devices (Class 2) n/a W a day  
Usefull energy / day n/a Wh  
Usefull energy / night n/a Wh

#### Power Needed

Total n/a VA  
Low consumption devices (Class 1) n/a VA  
High consumption devices (Class 2) n/a VA  
Average power necessary n/a VA

### Generator

#### Additional Information

### Additional Information

Voltage specification (single-P / 3-P)	Automatic selection ▼
Cable length between:	
the generator and switchgear	10 m ▼
the grid and switchgear	10 m ▼
the switchgear and the main electrical dashboard	10 m ▼
Wire Gauge recommendation:	
between generator and switchgear	n/a mm <sup>2</sup>
between grid and switchgear	n/a mm <sup>2</sup>
between switchgear to dashboard	n/a mm <sup>2</sup>

### Size Recommendations

Size recommended (PRP)	n/a KVA
Power (ESP)	n/a VA
Voltage type	n/a
Rated voltage	n/a V
Rated frequency	n/a Hz
Output circuit-breaker size	n/a A
Estimated fuel consumption	n/a l/h
Estimated oil consumption	n/a l/h
(1 oil change every 250h)	n/a l/250h

## Battery System

### Additional Information

Unit voltage	12	V
Unit capacity	1000	Ah
Authorized discharge ratio (no less than 40%)	50	%
Charge available time (minimum 4hours)	4	h
Days of autonomy needed if no charge	1	

### Recommendation

Energy to accumulate	n/a Wh
Voltage recommended	n/a V
Number of batteries needed with the specifications provided	n/a units
Type of connection	n/a
Circuit breaker ideal size	n/a A
Charger size at least	n/a A

## Solar System

## Solar System

### Additional Information

Solar daily irradiance	n/a kWh/m <sup>2</sup> /day
Usefull max power per day	n/a Wc
Regulator size	n/a A
Solar panels unit voltage (recommendation: n/aV)	12 V <input type="button" value="v"/>
Solar panels unit max power	<input type="text"/> Wc

### Recommendation

Minimum number of solar panels	n/a
Recommended number of solar panels	n/a
Solar charge controller: type of regulator	n/a
Solar charge controller: rated voltage	n/a V
Solar charge controller: unit max current	n/a A
Solar charge controller: quantity	n/a

[Open in full view](#)

## Energy Tools and Resources

### Templates and Tools

[Guide - Cable Sizing Chart](#)

### Sites and Resources

- [Sphere Standards](#)
- [SparkFun](#)
- [SolarGis](#)

### References

- RED R, (2002). Engineering in emergencies
- [MEDICINS SANS FRONTIERS, \(2007\). Electricity Support.](#)
- [ENGINYERIA SENSE FRONTERES, \(2006\). Tecnologías de la energía para el Desarrollo.](#)
- [MEDICINS SANS FRONTIERS, \(2004\). Energy Guideline](#)
- [ACTION CONTRE LA FAIM, \(2012\). Generator Guideline](#)
- MEDICINS SANS FRONTIERS, (2002). Power Supply.
- [ACTION CONTRE LA FAIM. \(2012\). Energy management Guideline](#)
- SAVE THE CHILDREN. Electricity distribution, generation and renewable energy guide.
- [ACTION CONTRE LA FAIM, \(2020\). Solar pumping, Electrical design and installation.](#)
- INTERNATIONAL COMITEE OF THE RED CROSS and MEDICINS SANS FRONTIERS, (2016). Electrical installation and equipment in the field, Rules and Tools.



- BP, (2000). Solar installation manual
- [MEDICINS SANS FRONTIERS, \(2012\) Electrical safety guidelines](#)

## Managing Health Supply Chains

“ Well-supplied health programs can provide superior service, while poorly supplied programs cannot. Likewise, well-supplied health workers can use their training and expertise fully, directly improving the quality of care for clients. [...] An effective logistics system helps provide adequate, appropriate supplies to health providers, increasing their professional satisfaction, motivation, and morale. Motivated staff are more likely to deliver a higher quality of service”

[\(USAID - Logistics Handbook, A Practical Guide for the Supply Chain Management of Health Commodities\)](#)

## Common Terms in Health Supply Chain

<b>Set Point</b>	The exact temperature refrigerated transport containers or storage containers are set at to accommodate the temperature control needs of the anticipated health commodities.
<b>GXP/GDP</b>	A set of standards for all supply chain actors involved to work with a common objective of ensuring product quality safety and efficacy when delivered to patients.
<b>Excursion</b>	Any variation above or below expected or accepted temperature ranges during the act of transporting, storing, or otherwise handling a healthcare item.
<b>Cold Chain</b>	The act of maintaining a set temperature across storage and transport throughout the entire supply chain, to ensure that temperature.
<b>Temperature Monitoring</b>	The act of continually monitoring the temperature of health items while in storage and transport.
<b>FEFO</b>	“First Expired / First Out” – A method of ensuring that the items closest to expiration are distributed and used first. FEFO is common practice in supply chain management of health items.
<b>Recall</b>	When a manufacturer or central health authority recalls specific health items, usually based on batch or production runs. Recalls impact all aspects of the health supply chain.
<b>Medical Waste</b>	Expired medication, used medical consumables, or any byproduct of medical activity that requires exceptional or specialized management.
<b>Reefer Container / Truck</b>	A truck or a container that has specialized, on board refrigeration capacity, including self-contained energy sources.

<b>Passive System</b>	Any system that maintains a temperature-controlled environment inside an insulated enclosure using a finite amount of preconditioned coolant in the form of chilled or frozen gel packs, dry ice, or others.
<b>Active System</b>	Externally powered or on-board powered systems using electricity or another fuel source to maintain a temperature-controlled environment. Common in cold rooms, refrigerators, temperature-controlled trucks, refrigerated ocean and air containers.
<b>Refrigeration Equipment</b>	Any equipment whose purpose is to lower air and product temperatures and/or to control relative humidity.
<b>Temperature-Controlled</b>	Any environment in which the temperature is actively or passively controlled at a level different from that of the surrounding environment within precise predefined limits.
<b>Datalogger</b>	Any device used to log temperatures of cartons or health items on an ongoing basis.

## Responding to Health-Related Needs in Humanitarian Emergencies

When a humanitarian emergency occurs, the local health system may not easily cope with the increased demand for health services. The prevalence of high morbidity, epidemics, pockets of inaccessible populations, or simply new pockets of high population density, may require increasing the provision of health services.

Additional health services may be translated in different logistics activities; upgrading or extending existing health facilities, building temporary or semipermanent structures, provision of health products, dealing with medical wastes, urgent transfer of patients between different service levels or transport of samples to reference laboratories.

In all these cases, it must be considered that health services fall under the responsibility of local health authorities. Coordination and alignment with existing systems is therefore of paramount importance.

### Regular health services provision and Health Care Supply Chains

Regular health service provision is often divided in different levels of care, referring to the complexity of the medical cases doctors treat and the skills and specialties of the providers. Levels are often divided into three or four categories:

- **Primary Care** - When a patient consults with your primary care provider.
- **Secondary Care** - When patient sees a specialist such as a traumatologist or endocrinologist.
- **Tertiary Care** - Specialized care in a hospital setting such as dialysis or heart surgery.

The health service package offered at a given level, including standardised treatment for specific diseases is usually harmonised across a given country or state. The selection of pharmaceutical products involves reviewing the prevalent health problems, identifying

treatments of choice, choosing individually needed medicines and dosage forms, quantifying the medicine requirements, and deciding which medicines will be made available at each level of the health care system. The number and type of health facilities that will offer specific levels of care is normally linked with demographics. This normalisation across geography, demographics, and treatments, helps planning and designing the Health Supply Chains.

Most of public health supply chain networks operate as a centralised system, where a central medical store receives health products from manufacturers, and regularly supplies it downstream to several regional medical stores, while regional medical stores will supply subregional medical stores which will supply to hospitals and health centres in the subregion. The number of distribution levels will also depend on geography, demographics, and political divisions.

In some countries, vertical programs, or disease specific programs such as nutrition, malaria, HIV-AIDS or TB, may have a dedicated supply pipeline and parallel logistics systems. This is because, historically, they often have separate standard operating procedures, different funding sources or distribution channels managed by separate administrative units. Recently many countries have moved toward product integration, combining the management of some or all logistics functions for different commodity categories (- like family planning, HIV, malaria, and TB - into a shared supply chain.

All the considerations above said must be measured by humanitarian agencies when responding to health needs in emergencies.

## General Concepts in Health Supply Chain

### Types of Health Commodities

“Health commodity” is a broad term that can refer to many items different in nature, and that may be needed for the provision of health services in humanitarian emergencies: scales, face masks, medicines, vaccines, preservatives, dressing material, alcohol used for medical procedures, needles and syringes, laboratory/diagnostic consumables, oxygen, etc. The sensitivity and stability of the product, the risks and the handling requirements, or the regulations for all these different items may be very diverse. The requirements for face masks or protective gloves are not the same as for medicines and vaccines so for an efficient and effective management of the supply chain, it’s important to know what products are being handled.

The most common terms used to define and categorise the types of health commodities are:

<b>Medicine (Including vaccines)</b>	Medicines can be defined as products including, but not limited to, finished pharmaceutical products, vaccines, and in vitro diagnostics (IVDs). A medicine is a substance or combination of substances that is intended to treat, prevent, or diagnose a disease, or to restore, correct or modify physiological functions by exerting a pharmacological, immunological, or metabolic action. Medicines usually have requirements for some level of temperature control, are usually considered fragile goods and often have requirements to limit light and humidity exposure. Vaccines are a subset of medicine products and are usually extremely sensitive to high or/and low temperatures.
--	--

---

<b>Medical Devices (Reusable and Consumable)</b>	Medical devices can be any instrument, apparatus, implement, machine, appliance, implant, reagent for in vitro use, software, material or other similar or related article, intended by the manufacturer to be used, alone or in combination for a medical purpose. This includes reusable medical devices (stethoscopes, forceps, endoscopes, surgical instruments, etc.) and consumable devices (needles, syringes, sutures, gloves, etc.).
<b>Hospital Equipment</b>	Hospital equipment can be any equipment, machinery, computers, tools, vehicles, software, furniture, or other infrastructure component used within a hospital or health facility environment. Hospital equipment generally does not have a temperature requirement but some of which may be considered fragile and have special requirements for transport (e.g. sensitive electrical equipment).
<b>Laboratory Equipment</b>	Laboratory equipment can include any support equipment or analytical instrument necessary to or involved in generating the results of a medical analysis. Some laboratory equipment have requirements for temperature control, are usually considered fragile goods and may have special requirements for transport of electrical components.
<b>Therapeutic Food</b>	Generally, includes ready-to-use therapeutic food (RUTF) and therapeutic milks (F-75, F-100) which are used in emergency response to manage acute malnutrition. Therapeutic food is generally not included in essential list of medicines or in other applicable essential health commodity lists, and therefore doesn't follow the same formal scrutiny as Medicinal Products. Although RUTF has been designed to resist harsh field conditions allowing management of malnutrition at community level, it always has an expiry date and exposure to high temperatures can accelerate the degradation mechanisms and reactions.

## Packaging and Labelling

Packaging and labelling are integral parts of the medical products as it is where the specifications set by the manufacturer for handling and consumption are described, including the expiry date. Packaging of medical items serves to preserve the product from contact to the environment and its conditions. All printed material is considered part of the packaging and is registered as part of the regulatory requirements of the NDRA.

The product label should include the following information as appropriate:

- Name of the product
- Active ingredient(s), type and amount
- Batch number
- Expiry date
- Special storage conditions or handling precautions
- Directions for use, warnings and precautions
- Names and addresses of the manufacturer and/or supplier

The expiry date and storage conditions of pharmaceuticals and medical devices are determined by conducting stability studies to mimic different environments around the world, and by testing that medications still meet their expected quality control specifications after predetermined durations under those conditions. If a day/month/year is not printed as an expiration date, international best practice is that the item can be used up to and including the last day of the month mentioned.

Medicinal products are often packed and handled in several layers of packaging:

- **Primary packaging** – Primary packaging is in direct contact with the medicinal product, such as glass vial and rubber stopper, or blister foil. Primary packaging material is selected as part of the development process of a new medicine to assure its integrity, sterility (for injectable products) and to protect from humidity.
- **Secondary packaging** – Secondary packaging is the container into which the product in its primary packaging is placed to be delivered for distribution to healthcare workers. Often, this is a folding carton. For most medicines, a pack of a known quantity of the product defines a “unit” for stock keeping purposes. Secondary packaging generally protects the product from light, vibration and physical shock.
- **Tertiary packaging** – Tertiary packaging is the container(s) into which, for most medicines, a number of units are placed for transport. Often this is known as a shipper carton. Tertiary packaging may also include insulated or thermal shipping containers.

Packaging materials in medicines are usually referred to as primary or secondary, with the difference being only primary packaging is intended to be in direct contact with the product. Tertiary packaging is not considered as part of the product.

There are strict regulations on the way medical products should be packaged and labelled. In emergencies, there may be a programmatic or operational rationale for repackaging or kitting/de-kitting of health commodities:

- Repackaging when it involves primary or secondary packaging is a manufacturing operation subject to strict national and international regulation and should be performed only at authorised premises (e.g. sterile) under the responsibility of a qualified person, or upon receipt at the health facility.
- Kitting/de-kitting which involves taking multiple secondary packages and repacking into different tertiary packages, (if it does not involve breaking down secondary packaging), is not considered pharmaceutical repackaging and can be conducted at the warehouse level depending on the national regulatory framework.

Health kits, as they are made up of a mix of items, have some modifications related to packaging and labelling on the tertiary packaging:

- Itemised packing lists should be included inside of each kit box, outside of each kit box, and on the pallet the kit(s) are shipped/transported on, with at a minimum: Name of the product, qty, batch number, expiry date, special instructions.
- Health kits are labelled with the “first item to expire” within the entire kit (even if the kit is more than one box/pallet).
- Health kits often have a separate batch/Lot number which identifies the entire kit from the supplier.
- Health kits should be labelled with the total number of tertiary packing (e.g. carton boxes) per kit and indicate the number of that specific tertiary package out of the total (e.g. box 7/12).
- If shipping multiple health kits per pallet, pallet wrapping should indicate the total quantity of each specific health kit for ease of receipt and inspection.

When planning logistics operation, it is of key importance to know what level of packaging is being mentioned, and the number of units per pack size, as volume and weight per unit may vary considerably. Incomplete or inconsistent information in the packaging of a medical product must raise suspicions and must be duly reported.

## **Regulated Commodities and Traceability**

Though the regulation in each country may vary, the national regulations are established to ensure that only authorised goods are supplied to the population, and that the goods are supplied end-to-end, with minimal impact on their quality, safety, and efficacy.

Traceability constitutes a continuous product identification system throughout the entire supply chain. Every stakeholder involved in the pharma distribution has the obligation to start up, apply and maintain an effective goods traceability system to guarantee that, in case of a product constituting a serious risk to human health, the product can be withdrawn from the market immediately. Clear identification of the products, including tracking product batch number throughout the whole supply chain is essential to safeguard traceability and enable item recall related reverse logistics. The principles of traceability help avoid the introduction of substandard or falsified (counterfeit) medicines into legitimate supply, as well as normalise which products are distributed and how.

As a best practice, all elements of distribution operations should be documented. Under local laws, all documentation pertaining to health items might be required to be made available for inspection by health authorities on request and may be required in the event of investigations or audits in the future.

Where national regulations are limited, or the urgency or the lack of resources do not allow surveillance of distribution activities, [WHO provides generic guidelines for the storage and distribution of medical products](#) that should be applicable where national regulations are limited, or resources or circumstances do not allow surveillance of distribution activities by local authorities.

## **Handling Requirements and Time and Temperature Sensitivity**

Many medical items are classified as time-temperature sensitive products; products which lose efficacy, or may even become dangerous, depending on exposure to temperature conditions outside of the manufacturing guidelines. These items are called time and temperature sensitive, as the usability of the product after an exposure depends on the length of time of the exposure and how severe of an exposure was documented. Nearly all pharmaceutical products, most consumable medical devices and IVDs, and many sensitive medical equipment are considered time-temperature sensitive.

To ensure quality, safety, and efficacy of the product, the specifications set by the manufacturer (for storage, transportation, and distribution) must be well known and respected. Manufacturers' specifications, such as the storage ranges for temperature and relative humidity, come from very specific stability studies meant to identify the limits of the medical items. Not managing the medical items within those ranges will lead to quality issues and may cause harm to patients. In addition, certain items are light sensitive and hence require appropriate packaging and avoidance of direct exposure to light to prevent item degrading or damage. Furthermore, the respect of handling requirements such as hygiene, avoiding degradation of the items, follow up of expiry dates and traceability are also often included in the legal requirements expressed by national regulatory authorities.

The most common temperature ranges used for handling of medical products are:

Temperature Range	Common Name
+15°C to +25°C	"Controlled ambient" or "Temperature-Controlled"
+8°C to +15°C	"Cool"
+2°C to +8°C	"Cold" or "Chilled" or "Refrigerated"
-25°C to -15°C	"Deep freeze" or "Frozen"
different ranges between -80°C to -40°C	"Ultra-low"

Terms like "ambient", "room temperature" and "cold chain" should be avoided when describing storage and handling needs as a whole, or when used as the only labelling for storage or transport of boxes/containers because these terms are not always clear and might have different meanings in different parts of the world. It is always better to indicate the temperature range to avoid confusion on the nomenclature when labelling goods or providing instructions for management considerations. General differences in nomenclature around the world might include:

Terminology	WHO	European Pharmacopoeia	US Pharmacopoeia	Japan Pharmacopoeia
Frozen/ deep-freeze	-20°C	>-15°C	-	-
<b>Refrigerator</b>	-	+2°C – +8°C	-	-
<b>Cold</b>	+2°C – +8°C	+8°C – +15°C	<+8°C	+1°C – +15°C
<b>Cool</b>	+8°C – +15°C	+8°C – +15°C	+8°C – +15°C	-
<b>Room temperature</b>	+15°C – +25°C	15°C – +25°C	temperature prevailing in a work area	+1°C – +30°C
<b>Controlled room temperature</b>	-	-	+20°C – +25°C excursions between +15°C and +30°C are allowed	-
<b>Ambient temperature</b>	+15°C – +25°C or +30°C depending on climatic conditions	-	-	-

*Adapted from ECA Academy "Regulatory Definitions for "Ambient", "Room Temperature" and "Cold Chain"*

Storage conditions are always better explicitly specified in terms of a defined temperature range (e.g., +15°C to +25°C or +2°C to +8°C). Particular attention should be given to avoiding freezing of liquids and semi-solids.

It is a common regulatory expectation to keep track of temperatures at which products have been stored. Keeping records of expiry dates and batch numbers is also a GDP requirement.

**Set Point** – A set point is a term that is frequently used in both storage and transport of temperature regulated items. A set point is defined as the temperature at which a powered refrigerated storage or transport container is configured to keep the goods in the desired temperature range. A set point of +5°C is often used in appliances for storage or transport between +2°C to +8°C, letting +/- 3 degrees C of margin before experiencing a temperature deviation.

**Temperature Monitoring** – Monitoring of health times refers to the manual or automatic method of monitoring and tracing the temperature environment of health items while in storage or in transit. There are a variety of monitoring techniques and equipment, and their use will depend on the nature of the transported goods, the local infrastructure, and monitoring requirements put in place by national authorities.

## Temperature Excursions

A temperature excursion is defined as any deviation from pre-defined specific temperature



range for a product during storage, transport, or handling. Temperature excursions can be caused by faulty equipment not regulating temperature, improperly set equipment, or items being handled transported or stored under inappropriate conditions. Excursions can be caused by relatively simple things, such as a door to a refrigerated container being left open for too long during loading or unloading, or a vehicle being parked in a sunny spot. Generally, temperature excursions are informed by temperature monitoring equipment that log the extent or duration of the excursion, however even without monitoring equipment excursions can be noted using common sense, such as identifying temperature regulated cargo left in the sun.

The response to an excursion depends on the severity of the excursion, and on the nature of the impacted goods. Routine basic pharmaceuticals that experience a temporary excursion may not require extra special attention, while refrigerated vaccines exposed to the same excursion may be considered completely unusable. In the event of an excursion:

- The personnel transporting or managing storage of the temperature regulated health items should take note of the excursion, and make a physical written record as required by your agencies protocol.
- The senior logistics or supply chain manager should be notified, who will need to take the appropriate action within your organisation's rules and regulations for quality risk management:
  - A quality assurance specialist or focal point may need to be sent the documents which outline the deviation (e.g. datalogger information) to advise on the usability of the product and/or instructions.
  - Depending on the end use of the items, the ultimate consignee might need to be notified of any temperature excursions along the supply chain.
  - In some contexts, local or national health authorities might need to be notified of any temperature excursions.
  - The staff pharmacist or health program manager may need to be notified to take appropriate actions.

In severe cases, agencies may need to contact the manufacturers of the health items to understand how to best handle the situation.

- The cause of any temperature deviation should be documented, and mitigation measures should be implemented immediately to avoid future damages to additional products.

In the event that a temperature deviation results in an unusable product the logistics or supply chain personnel may need to dispose of the item in line with national medical waste management protocols. This may involve reverse logistics.

## **Regulatory Frameworks for Health Supply Chain**

A specific component to health supply chains that is frequently overlooked or underestimated by humanitarian organisations is the overall regulatory framework in which management of health commodities resides. Different operating contexts will have extremely different regulations and laws governing the procurement, storage, transportation and distribution of pharmaceuticals and other health items. In many contexts special certifications or permits are required to even handle health items, and in some cases humanitarian agencies may outright be incapable of managing their own health supplies without utilising an accredited third party.

Over the past few decades there has been increasing attention to how health items are managed on both a national and international level, and many traditional humanitarian

emergencies may now be facing stricter regulations than before. Alternately, some humanitarian contexts have virtually no local or national regulations pertaining to the management of health items, and responding organisations must do their best to maintain a minimum level of quality for the management of health items.

Humanitarian organisations should be aware of local regulations when they begin a health-related project in any given country and should consult with national or local Ministries of Health, Food and Drugs Administration Authorities and National Drug Regulatory Authorities, or other relevant ministries about the prevailing laws and regulations prior to beginning activities.

## Good Distribution Practice (GDP) for Medical Products

Good Distribution Practice (GDP) is a set of standards for all supply chain actors involved to work with a common objective of ensuring product quality safety and efficacy when delivered to patients. GDP applies equally to forward supply, to reverse logistics, to commercial supply chains, to private and public health supply chains, whether items are procured directly or donated. The objective of adherence to GDP is to ensure that goods are supplied from the manufacturer to the population with minimal impact on their quality, safety and efficacy, and to ensure the avoidance of infiltration of falsified, counterfeit or substandard products into legitimate supply chains. GDP is the responsibility of all actors' participants in the distribution process to ensure that procedures are designed to protect the products and the recipient population.

GDP encompasses many aspects of the management of pharmaceuticals and health commodities that humanitarian organisations might encounter, however there are many other categories of quality assurance management for categories for health supply chains, including:

- Good Manufacturing Practice (GMP)
- Good Pharmaceutical Practice (GPP)
- Good Storage Practices (GSP)
- Good Trade and Distribution Practice (GTDP)



Often, the different special categories of practice are all labelled as GDP. The specific nomenclature is not as important to humanitarian actors – the important part is that humanitarian organisations managing a supply chain of health items understand what their obligations are, based both on the type of commodities and the prevailing regulations in the context of operation. The point of a GDP is to ensure that the following components of a health supply chain are adequately planned and developed:

- Traceability and Inventory Management.
- Necessary Equipment.
- Storage and Transport Standards.

- Documented procedures.
- Responsibilities for GDP set out in job descriptions.
- Quality risk management.
- Management of Outsourcing.
- Management of Change, Deviations and Corrective Actions and Preventive Action (CAPA).
- Self-inspections.
- Systems for handling returns, complaints and recalls.
- Notification to senior management of GDP compliance and performance.
- Training of personnel.

The World Health Organisation (WHO) [maintains detailed guidance on GDP](#) that is regularly updated, and is available to all healthcare practitioners. However, many countries and national authorities maintain their own specific GDP requirements that vary from context to context and require their own study and compliance. Many Ministries of Health (MoH) produce publications or maintain websites with regulations and resources available for the public - Humanitarian response organisations should inquire about GDP regulations in any context in which they operate prior to enacting procurement or establishing health activities.

## Procurement and Sourcing of Medical Items

Unlike sourcing many routine humanitarian relief items – such as durable goods or NFIs – the procurement of health items comes with many of its own caveats.

**Registration of Pharmaceutical Products** - In most countries, companies that produce, import and sell pharmaceutical products are required to obtain prior evaluation and approval from a governing body, often called the national drug regulatory authority (NDRA), or a stringent regulatory authority (SRA). Products to be registered should be proven to be effective, safe, and of good quality. Registration is often also called Marketing Authorisation (MA). Due to the fact the quality of the medications is checked as part of the registration process, each brand (produced by different manufacturers) is registered independently. In most cases, not only the product, but also the packaging, is registered. National Marketing Authorisation often have limited validity and must be renewed with certain periodicity. Pharmaceuticals intended for import as part of the humanitarian assistance (for non-commercial use purpose) may be exempted from registration of pharmaceutical product in the host country. It is important not to assume this will be the case and verify details with respective authorities in country prior to the dispatch of goods.

**Essential Medicines List** - Each country defines its own essential list of medicines (EML), aiming to satisfy the priority health care needs of its own population. Essential medicines are selected with in reference to disease prevalence and public health relevance, evidence of efficacy and safety, and comparative cost-effectiveness. Essential medicines are intended to be always available within the context of functioning health systems in adequate amounts, in the appropriate dosage forms, with assured quality and adequate information, and at a price the individual and community can afford.

The World Health Organisation (WHO) maintains what it calls the ["Model List of Essential Medicines"](#), a list of formally recognised medications that WHO reviews and endorses for use for populations around the world. The model list of essential medicines is reviewed every few years, and medication is either added or removed based on advice derived from the most up to date clinical data. The contents of the model list are [searchable via an online database](#). The model list of essential medicines is not the definitive list of usable drugs in all contexts, nor is the list of all approved drugs – it merely serves as guide for national authorities, manufacturers and importers to reference. More information on now national level essential medicines are

developed can be found in WHO's guide on the [Selection of Essential Medicines at Country Level](#).

The majority of countries in which humanitarian organisations operate have adopted at least part of the model list of essential medicines, but it is very common for countries or national authorities to add or remove medications to the list to cover their own importation needs. Countries may choose to add or remove medications for sociocultural or political reasons, and some countries or regions have extremely robust and complex regimes for defining acceptable medications and dosages.

*“ Many pharmaceutical products can be registered for use in a country, but they may not be on the national EML, or on the standard treatment guidelines. Products not on the EML, but used by the private sector, can still be registered if their efficacy, safety, and quality are acceptable to the regulatory authority. Failure to follow the pharmaceutical registration protocol could lead to products being held up by customs when they enter the country. Not only does this delay the delivery of important health care products, but it wastes time and money, and risks spoilage or expiry of products while at customs.”*

([USAID - The Logistics Handbook, A Practical Guide for The Supply Chain Management of Health Commodities](#))

National Drug Regulatory Authorities may also normalise where health products are sourced, in what shape and dosages are presented, what minimal identification and use indications shall be provided, etc.

It is often considered that the procurement is the crucial point of Quality Assurance (QA) of medicines. The source of the raw materials (active ingredient, excipients - an inert substance used to give a pharmaceutical preparation a suitable form or consistency), as well as the way the final pharmaceutical product is manufactured determines the intrinsic quality of each medicine.

## Donor Regulations

A significant portion of funds used to procure health related items in an emergency comes from large scale institutional donors. Many donors have well established procedures on what and how medicines and medical support devices can be purchased using their funds.

Most major institutional donors only allow recipients of their funds to procure pharmaceuticals through pre-qualified suppliers. Pre-qualified suppliers must undergo thorough audits and must be regularly reviewed for their quality assurance standards. As a result:

- There are a limited number of pre-qualified suppliers globally, and frequently they are outside the areas of the emergency.
- Different donors don't always pre-qualify the same supplier; If an aid organisation receives funds from more than one donor, they may be obliged to buy from different sources depending on the funding type.
- Some pre-qualified vendors function as non-profits, while others are commercial enterprises. This may impact product costs and availability.

The variability and geographic specificity of donor pre-qualified vendors mean that humanitarian organisations should research their relevant donor regulations prior to purchasing pharmaceuticals and other health items. The relatively small number of suppliers also means that procurements will likely need to be imported – please reference the section on [Importation and Customs](#) for more information.

## Product Names

*“The selection of the medicines to be provided in a country affected by an emergency is of key importance because, if the medicine is not well known by the health professionals who will prescribe it, it will not achieve its intended use.”*

[\(DG ECHO - Review of quality assurance \(QA\) mechanisms for medicines and medical supplies in humanitarian aid\)](#)

Sometimes pharmaceutical items can be referred to by a variety of names. When ordering drugs please consider the following points.

**International Non-proprietary Name** - An international non-proprietary name is a unique name that is given to the product based pharmaceutical substances or active pharmaceutical ingredients and is generally globally recognised.

**Brand Name** - For marketing purposes, brand names are generated by a particular manufacturer and will generally be trademarked. All brand name products will still carry an international non-proprietary name as well, as there should be no difference in chemical composition from one brand to the next. Some pharmaceuticals that hold brand names may still be under patent by one Manufacturer. These products are usually given patent protection for 20 years from the date the patent was submitted and provides protection for the innovator of the medicines to recover the initial costs incurred in research development and marketing expenses.

**Generic Drug** - A generic drug is a pharmaceutical that is produced and distributed without patent protection. It has the same active ingredients as brand names, but it can be manufactured by a different producer.

It's strongly recommended to use international non-proprietary names to refer to medicinal products. Using the international non-proprietary names enables you to purchase products from multiple suppliers, whether branded or generic, and manage them as the same product.

## Health Kits

A common procurement strategy for health items in humanitarian emergencies is the design and use of [emergency health kits](#). These standardised kits of medicines and medical supplies are developed by agencies to meet different health needs in humanitarian emergencies and disasters during the acute emergency phase, normally during the first 3 months, when [a push model](#) is critical to launch the operation. It's key to note that after the acute phase of an emergency is over, or during chronic emergencies, the quantity of needed medicines should be reassessed base on operational needs, and a routine supply of health items should come from consumption-based demand.

The most widespread and accepted emergency health kit is the [Interagency Emergency Health Kit \(IEHK\)](#) developed by WHO, however there a variety of other kits that support trauma surgery, maternal and reproductive health, newborn health, and specific infectious diseases produced and managed by different humanitarian organisations. Emergency health kits may include a mix of pharmaceuticals, medical devices and equipment, and are designed based on treatment of specific medical conditions common in emergencies. The contents of each kit are designed to attend specific diseases, for a specific number of patients during a given period of time using assumptions based on global standard treatment protocols.

The advantage of emergency health kits is that they are uniformly recognised and stocked

across multiple organisations and vendors and are generally recognised by governments. A pharmaceutical manufacturer or supplier can assemble, or stock health kits based on known and pre-approved components, and customs and health officials at the national level have known documentation on what may be included. Depending on the organisation responsible for the specific kit(s), content is usually updated every few years to be compliant with updated clinical guidelines and based on other changes in the medical supply landscape.

Use of the word “kit” should not be mistaken as a singular box or bag. The majority of health kits consist of more than one box, and in some cases multiple pallets per single kit. Additionally, a number of health kits contain a mix of health product categories – such as temperature-controlled items, keep cool items, dangerous goods, or controlled substances – and management of health kits requires keen attention and the implementation of quality risk management throughout distribution.

Some larger humanitarian organisations may choose to develop their own health kits, which may or may not be available to other agencies for procurement. Prior to developing health kits, agencies should consult what is available on the market, and keep in mind the need to conform to international standards, such as essential medicines lists, while doing so.

#### **Advantages of Pre-Made Health Kits**

#### **Disadvantages of Pre-Made Health Kits**

- 
- |   |   |
|---|---|
| <ul style="list-style-type: none"><li>• Kits are pre-defined for specific health emergencies and reduce the complexity of ordering on short notice.</li><li>• Kits are useful when beneficiary data is limited, and no proper demand is fully understood – this is very common in the early phases of emergencies.</li><li>• Kits are fast to order – vendors have well defined and premade kit contents, and sometimes even stock them in advance.</li><li>• Kits are fast to distribute – in many cases, kits will arrive in clearly marked packages, and already be segregated into easy-to-handle cartons. Kits also don't require field level users to break down and re-kit larger bulk orders.</li></ul> | <ul style="list-style-type: none"><li>• Kits don't always fulfill the supply needs for comprehensive services and tend to only target lifesaving needs for specific medical practices.</li><li>• Kits are designed based on global averages on prevalence of clinical interventions for low- and middle-income settings, and assumptions on supply requirements for each clinical intervention based on WHO treatment protocols. As a result, the kits are not based on the national treatment protocols in a specific country or on the specific service seeking behavior of the targeted population.</li><li>• Kits in their design are inherently more expensive than bulk procurement of the items contained within the kit.</li><li>• Kits may have a shorter shelf life. Many kits are held in stock at the global level prior to dispatch to a specific country, and the shelf life of individual items in the kits will be shorter than items with expiration dates taken from regular vendor rotation.</li></ul> |
|---|---|
- 

## **Donations of Medicines and Health Supplies**

There are many different scenarios for medicine and health material donations – such as emergency aid, long- term aid, or assistance to national health systems or to individual health facilities. Donations may come from pharmaceutical companies (directly or through private voluntary organisations), they may come in the form of aid from governments, or they may be donations aimed directly at single health-care facilities. The intended beneficiaries of donations

of medicines range from individual facilities to entire health systems. Although there are legitimate differences between these scenarios, many basic rules for appropriate donation practice apply to them all.

WHO in cooperation with major international agencies active in humanitarian relief and development assistance, developed the [Guidelines for Medicine Donations](#). The guidelines are intended to improve the quality of medicine donations in international development assistance and emergency aid.

The guidelines aim to describe a common core of good medicine donation practices based on a few core principles:

1. Donations of medicines should benefit the recipient to the maximum extent possible. All donations should be based on an expressed need. Unsolicited medicine donations are to be discouraged.
2. Donations should be given with due respect for the wishes and authority of the recipient, and in conformity with the government policies and administrative arrangements of the recipient country: all donated medicines or their generic equivalents should be approved for use in the recipient country and should appear on the national list of essential medicines or equivalent or in the national standard treatment guidelines, if the national list of essential medicines is not updated.
3. There should be effective coordination and collaboration between the donor and the recipient, with all donations made according to a plan formulated by both parties.
4. There should be no double standard in quality. If the quality of an item is unacceptable in the donor country, it is also unacceptable as a donation.
5. Items must not have less than minimum required shelf life upon arrival to allow timely distribution and consumption without causing unnecessary reverse logistics activities and related costs.

Different humanitarian organisations will have internal requirements and processes for the acceptance of donations of medical and health supplies which aim to ensure compliance with WHO guidelines for medicine donations.

## **Importation and Customs of Medical Items**

In addition to the [regular procurement policies and procedures](#) used for importing goods in any humanitarian context, there are additional components specific to the importation process of pharmaceuticals and health items that humanitarian organisations should be aware of. The importation of pharmaceutical products is normally done in compliance with national regulations established under the National Medicines Regulatory Authority (NMRA). In most countries, NMRA is the national agency responsible for the marketing authorisation of, and other regulatory activities concerning pharmaceutical products.

In principle, the NMRA will restrict the importation of unapproved and substandard medicines, as this poses a serious risk to public health. For controlling purposes, specific requirements are expected for the importation of goods such as medicines, vaccines and biologics and medical devices and other health supplies (not exhaustive: will depend on local regulations):

- Only designated ports or points of entry specifically authorised for importation may be used to channel consignments of pharmaceutical products.
- Only pharmaceutical products proved by appropriate documentation to be duly licensed for marketing or specific intended use such as clinical trials, personal use or other means as appropriate should be cleared by customs. When new products are required for

importation, an emergency authorisation must be released by the local authorities.

- All importation of pharmaceutical products may be done by authorised importers only.
- Quality sample testing may be required, being unable to release the goods until the results are provided. In some cases, testing occurs at the time the goods arrive, or even after they have cleared customs.
- Specific requirements may be put in place related to minimum shelf life on importation.
- Additional restrictions and licenses may be imposed for importing different narcotics (controlled substances) and [dangerous goods](#).

In addition to restrictions on importation, many times NMRAs or other authorities might also restrict the export of certain health items as well. Requirements for restriction of exportation may vary, depending on sensitive local markets, politics, or regulations on controlled substances. Exportation restrictions may impact reverse logistics of removing drugs but may also impact drugs exported from manufacturing or prepositioning facilities in more developed countries as well. Importers/exporters should review legislation requirements prior to exporting any items and should consult with a knowledgeable customs broker.

## Emergency Procedures for Import

In emergencies, import regulations may change. Depending on the type of emergency and the political climate, the regulations on import might change substantially; when confronting a major natural disaster or health emergency such as a pandemic, the authorities are prone to be more flexible with their importation procedures. By contrast, emergencies caused by political instability may cause the rules and regulations may become more challenging and the paperwork more burdensome.

The type of registration obtained by the humanitarian organisation may affect its ability to import medicines in case of an emergency.

- If organisations are registered under the ministry of health as a medical NGO, importation of medicines and health products may become easier.
- Declaration of non-commercial use of the products, or the donation to the Ministry of Health may also ease the process.

Waivers in emergencies specific to health supply importation (depending on the context) may include:

- Waivers on importation based on NDMO.
- Waivers on importation based on national registration.
- Reduction on documentation and testing requirements.
- Waivers on restrictions to country of origin.
- Waivers on restrictions of import to specific ports of entry.
- Waivers on restrictions of authorised importers.
- Waivers on minimum shelf life requirements (If required for advocacy: see attached Appendix 2 to the WHO Points to consider for setting the remaining shelf-life of medical products upon delivery, which specifies for governments examples of minimum remaining shelf-life for emergency health kits for use as part of humanitarian response).

## Customs Concepts Common to Health Items

### Banned/Allowed Items

Prior to attempting to import any pharmaceutical or health item into any country,



humanitarian organisations should research regulations on what can and cannot be imported. This is especially important in rapid emergencies where organisations may wish to import pre-made kits or prepositioned stock or undertake a rapid procurement that may or may not contain items that are not permitted to be imported for whatever reasons.

Methods that humanitarian organisations can use to identify banned/allowed items for import include:

- Speak with a registered customs broker.
- Consult ministry of health websites or other online sources.
- Reference [the database of approved essential medicines per country](#).

#### **Documentation:**

In addition to the regular documentation required to import any item, there are additional documentation or steps that may relate to health items, with particular emphasis on pharmaceutical and live vaccines. These might include:

- **Certificate of Registration** – Proof that the medicinal product is duly authorised by, to be marketed or otherwise so authorised for use in clinical trial or for personal use.
- **Import License** - Proof the importer is duly authorised to undertake the transaction.
- **Certificates of Analysis (CoA)** – CoAs include information on laboratory testing for specific batches or lots of pharmaceuticals and other health items. Sometimes CoAs can be provided by the manufacturer, but some national authorities require CoAs from recognised outside sources to prevent fraud.
- **Laboratory Samples** – Some customs and health authorities require laboratory testing on imported goods once they arrive in-country. This usually entails samples taken from supplies prior to clearing customs and being sent to state managed or mandated laboratory testing sites.
- **Other Common Forms** – Safety Data Sheets (SDS), Certificates of Origin (CoO), Certificates of Inspection (CoI), Certificates of Conformity (CoC), Pre-shipment Inspection (PSI) as applicable. More information on other common forms [can be found here](#).

#### **Cold Chain Items:**

For cold chain products, there may be fast track procedures, enabling a preliminary reception of the goods while clearance procedures are concluded at a later stage. In any case, for any temperature-controlled range, it is strongly recommended to assess the customs facilities for their capacity to receive and properly handle items.

#### **Transit Regimes:**

Many countries now have strict regulations on handling health items under their own national GDP, and health items may only be released to a limited number of pre-identified entities, such as central medical stores or state appointed companies. In instances where humanitarian organisations may wish to transit health items through one country into another neighbouring country, there may be limitations on the types, quantities, or time frame in which some or all health items can transit.

#### **Physical Considerations:**

Depending on the port of entry used for importation of medical items, there will be different infrastructure available and different levels of knowledge on the handling staff related to medical supplies.

In larger centralised airports and sea ports, where the private/public sector have already been importing medical supplies, the likelihood is higher that the correct temporary storage infrastructure, handling equipment, standard operating procedures and capacity of handling staff is in place.

In smaller air and sea ports, or in locations where the entry point operation has been impacted by the emergency - such as damage to infrastructure or displacement of handling staff - there may be gaps in the proper infrastructure, capacity, and processes related to maintaining the safeguarding and quality of medical supplies.

Bottlenecks or gaps, which need to be mitigated for, may include:

- Lack of available (or insufficient space in) covered storage location.
- Lack of available (or insufficient space in) temperature-controlled storage (or reefer connectors in sea ports).
- Lack of available (or insufficient space in) keep cool storage locations (or reefer connectors in sea ports).
- Lack of knowledge of handling staff on fragile goods handling.
- Lack of proper handling equipment.
- Lack of special operating procedures within standard operating procedures dedicated to offloading and immediate temporary storage of medical supplies in relevant storage locations.
- Lack of controlled access storage for controlled substances.
- Lack of process or infrastructure for segregation, destruction or movement of damaged/expired medical supplies (pre or post clearance).
- Lack of knowledge on preparation of keep cool items for onward dispatch when cleared.

Solutions, which will often require engagement with relevant national authorities and port operating agents may include capacity development of personnel, procurement of ad hoc infrastructure/equipment (temperature controlled MSUs, refrigerated containers, freezers, generators, etc.), or deployment of dedicated specialised personnel to the entry point.

## **Storage Facilities for Medical Items**

There are special considerations in the storage and management of health products. Health supplies have specific characteristics which may increase their risk of damage (e.g. fragile, temperature sensitive, light sensitive, flammable), which may increase the risk to beneficiaries if not stored properly. Ensure warehouses selected can, in general:

*Store medicines/medical supplies appropriately in line with manufacturer labelling. This may include:*

- Keeping items away from direct sunlight.
- Regulating the humidity in the storage area.
- Maintaining proper temperature for different products.
- Storing medical supplies separately from chemicals or food (pesticides, fertilisers, cement, fuel included), and dangerous goods. This also applies when loading onto vehicles.
- Storing narcotics and high value items in a secure location, in line with national rules and regulation.

*Practice proper basic inventory management and tracking, including:*

- Storing items in rational manor (e.g. organised by type).
- Taking regular temperature checks of different storage areas.
- If stored on pallets, clearly labelling all cartons with their contents.
- Keeping proper records on bin cards and in inventory logs - always including batch numbers and expiry dates upon receipt and record batch references at all stock movements, including on all stock/bin cards and all warehouse ledgers.
- Using and understanding First Expire First Out principles (FEFO).

*Manage safely expired and damaged products:*

- Quarantining expired or damaged drugs until they can be safely destroyed.
- Keeping a record of drugs placed in quarantine on the relevant bin and stock cards.
- Having a process for expired/damaged items. These drugs/consumables should be destroyed safely in line with WHO and national government regulations.

A temperature-controlled storage area is any place in which the inside temperature is consistently maintained within a predefined temperature range.

Humanitarian working conditions often have limited or no temperature-controlled storage capacity, so the need for temperature-controlled conditions must be factored into operational plans when selecting and establishing storage. Any form of temperature-controlled space will require basic equipment – air-conditioners, refrigerators, freezers – and some form of power, most commonly electricity, generator, or solar based solutions. It is essential to look at specific packaging and labelling requirements of specific products and obtain this information ahead of receipt of goods.

The majority of health items with time-temperature sensitive conditions used in a humanitarian environment require storage between +15°C to +25°C. However, a critical component of the medical supply chain will require +2°C to +8°C storage, including lifesaving drugs, blood transfusion items and some vaccines. In special cases, including outbreaks of infectious diseases, or where specific medical interventions are planned, other temperature categories may be required.

Depending on the outside ambient temperature, it may be essential to specifically contract/modify storage spaces to have dedicated temperature zones within warehouses. Specific infrastructure, equipment and power solutions need to be considered in planning and the design of warehouses.

## **Temperature Zones**

A “temperature zone” is any discrete area inside of a storage facility that has a measurable temperature different than other parts of the same warehouse or storage facility. Temperature zones are usually caused by warmer air rising to the top of a warehouse causing stratification, however temperature differences can also be caused by proximity to doors and windows, pipes or running equipment that may radiate heat.

Temperature stratification is the process of heat separating in an enclosed space – warmer air rises, and in larger facilities the temperature differential between the bottom shelf and a top shelf can be both noticeable, and cause damage if left untreated for a long time. Temperature

stratification can be prevented by installing fans or air conditioners that are specifically designed to rotate air, or by intentionally limiting the height of storage for smaller facilities.

Humidity can also be a problem in some climates, and where required electrically powered dehumidifiers can also be installed. Logistics planners should note that primary packaging materials are chosen to protect the medicine from expected humidity in the climatic zone where the product is to be used, so requirements for controlling humidity may be dependent on product types and product sourcing.

For ranges above freezing, temperature is most efficiently controlled by a balanced combination of active and passive techniques. Depending on the climate, these are likely to include:

<b>Insulation</b>	<ul style="list-style-type: none"><li>• Install high quality insulation on the walls inside of the storage structures.</li></ul>
<b>Self-Contained Room</b>	<ul style="list-style-type: none"><li>• Build an internal cold storage room within the facility. Ideal standalone cold storage rooms will have an airgap surrounding it to increase insulation. Airgaps should be situated in a way to prevent airflow through the open space.</li></ul>
<b>Minimise Heat Gain/Loss</b>	<ul style="list-style-type: none"><li>• Close or Minimise gaps around doors and windows.</li><li>• Ensure that doors are only open as long as necessary.</li><li>• Use plastic flaps over cargo doors.</li></ul>
<b>Passive Techniques</b>	<ul style="list-style-type: none"><li>• Use natural or man-made shade over/outside storage structures.</li><li>• Properly installed soffit vents or roof vents can help disperse or move heat.</li></ul>
<b>Prevent Temperature Stratification</b>	<ul style="list-style-type: none"><li>• Use active measures to prevent heat stratification of temperature, including fans.</li></ul>

## Active Cooling

Active cooling requires power for part of or all of the day, and whatever active cooling device is used must be adequate to accommodate the storage space. Choosing which type of active cooling system, and how many/the size of the unit(s) required will depend on a number of factors, among them the size of the space, the external ambient temperature and the ideal temperature range.

Some storage facilities will have properly installed or adequate temperature controls in place already, and active cooling can be achieved directly through a central control mechanism. In other instances, humanitarian organisations may need to install their own active cooling devices. Prior to installation of any unit, consult with a qualified installer so that they might understand both the size and the temperature requirements.

**Monobloc Air Conditioners**

Self-contained air-conditioning units – monobloc are single units that put out cool air from one side, but radiate heat from the other. Monobloc conditioners may not be suitable for smaller cold rooms built inside of a larger warehouse space, as all heat waste would be discharged into the open warehouse.

---



**Split Air Conditioners**

Split air conditioners have two components that are separated, but connected by a long tube of freon coolant, and usually have a single power source. The advantage of split air conditioners is that the heat output can be placed outside meaning it can be larger, noisier, and won't impact indoor ambient temperatures.

---



## Freezer Units

Freezer units are used for rooms that need to be near or below freezing temperatures. Freezer units are typically very large and need to be mounted on the roof of the storage area to maximise the flow of cold air.



In actively cooled spaces, there are some special considerations:

- **Floor insulation** - Sometimes freezer rooms have insulated flooring as well. Insulated floors will help keep energy costs down as less heat is absorbed from the ground. Additionally, cold rooms can cause something called “frostheave” in which water in the ground under the storage site is frozen, causing the ground to shift and crack.
- **Heat output** – Regardless of the method, any form of active cooling will have some form of heat output. Spaces should be designed with heat being expelled outdoors wherever possible. Exhaust heat should also not endanger the health of workers or cause potential fire hazards.
- **Energy needs** – Active cooling always requires some form of power. Usually even medium sized spaces require more power than a solar electric system can provide.
- **Duration** – Not all active cooling systems need to be powered or cool the air at all times. The needs for part time cooling depend on the insulation value of the structure, the outside temperatures, the time of year, and the types of medicines stored. Before installing a system that will only have access to intermittent power, a proper heat mapping exercise should be conducted, and an assessment of the medical items should be finalised.
- **Condensation** – In the process of air conditioning, when hot air gets cooled as it passes through the evaporator coil - often in the indoor part of the refrigeration system - water condensation occurs, and water needs to be collected and exhausted in a controlled manner.
- **Uneven distribution of cooled air** - Depending on the refrigeration system, the load configuration and the chamber design and its performance, the air temperature is distributed unevenly and deviations from the Set Point in some spots may be larger than expected, putting at risk the stability of the goods stored/transported in it.

Note: active heating may be required in some instances. In storage areas that are prone to extreme cold, or when operating in climates with extreme cold, active heating may also be required in order to maintain the manufacturer specified temperature ranges. Many temperature control devices – such as air conditioners – also have heating functions built in. The important thing for active heating is that temperature ranges also do not exceed the required temperature ranges.

## **Renting Commercial or Third Party Managed Medical Storage**

Whether humanitarian organisations are planning on moving relatively small quantities of health commodities, or maintain a large, dedicated health supply chains, they should consider using the commercial market wherever available.

Properly qualified commercial service providers have many advantages:

- They likely already have access to expensive or specialised equipment used for properly maintaining pharmaceuticals and other health items.
- They will have an understanding of the prevailing regulatory requirements for managing health items in the local context and should have proper certifications/authorisations to do so.
- Will have access to specially trained staff.

Prior to engaging with or renting a privately managed medical storage facility, there are some things that humanitarian organisations may want to consider.

- When submitting a request for quotation for potential service providers, humanitarian agencies should:
  - Outline the types of commodities that will be stored in as much detail as possible. This will enable storage providers to more easily identify areas in which they may or may not have capacity to support the overall needs of the agency.
  - Ask if private companies have the required national certifications to store health commodities / ask to see copies of registration/certification where required. This may include special authorisation to store controlled substances.
- Agencies should consider the total scope of needs required. Do they require:
  - Reconditioning of passive cold chain boxes?
  - Pick and pack / kitting?
  - Re-palletisation/ Labelling?
  - Specialised inventory or reporting?
- Does the company provide disposal services for expired medical items?

## **Self-Managed Medical Storage**

Humanitarian organisations are frequently faced with having to develop and manage their own storage facilities, often in locations with limited access to improved infrastructure. When identifying a self-managed storage facility, there are a few things to consider:

### **Stand Alone Medical Storage Locations**

In addition to [the traditional factors surrounding the selection of regular storage locations](#), medical storage locations may have additional or extra considerations. Medical facilities that require some form of temperature control benefit from:

- **Proximity to health facilities** – the closer medical storage locations are to the final

distribution points, the less complicated the process transporting temperature-controlled items are.

- **Proximity to manufacture or central medical stores** – Upstream or distribution warehouses may want to be closer to facilities that produce medical items, or to national authorities that may supply or distribute medical items themselves.
- **Persistent electricity** – storage locations requiring temperature control that have access to regular and consistent grid power and have access to backup generators run a much lower risk of damage to stored items from gaps in power.
- **Shading** – The availability of partial or full shade over a storage facility can greatly reduce temperature fluctuations and reduce demand for electricity.
- **Controlled access areas** - The availability of locked cages, locked rooms or locked storage cabinets for high value and controlled substances can reduce risks of theft and ensure compliance with legal requirements.

## Medical Storage Rooms in Mixed-Use Warehouses

In the absence of dedicated temperature-controlled storage spaces, humanitarian agencies can construct or utilise pre-existing self-contained temperature-controlled spaces inside of pre-existing storage facilities. Self-contained temperature-controlled spaces in larger warehouse structures have the advantages of:

- Being able to be scaled or right sized to the required volumes of climate controlled cargo items.
- Being able to co-locate non temperature-controlled items in the same storage facilities.
- The ability to build multi-chamber storage rooms to accommodate different temperature ranges.

Special temperature-controlled rooms constructed within the main building of a warehouse must still be appropriately insulated and must have some form of active temperature control to maintain the required range. National regulations may require a certified pharmacist among staff as mandatory precondition to manage pharmaceuticals.

## Temperature Monitoring of Storage Locations

### Temperature Mapping

Temperature mapping is the process of identifying and marking temperature zones inside of a warehouse used for storage of temperature sensitive commodities, including all anticipated temperature ranges required for storage. Whether or not humanitarian agencies are utilising an outsourced storage facility, or they are managing their own facilities, it is advisable to conduct a temperature mapping exercise so that warehouse managers can best utilise the available space. For more information on evaluating commercial climate-controlled space, reference WHO's guide on the [qualification of temperature-controlled storage areas](#). For more information on conducting temperature mapping on self-managed spaces, please reference WHO's guide on [temperature mapping of storage areas](#).

An ideal temperature mapping exercise utilises automatic temperature loggers, however humanitarian organisations might utilise handheld devices such as digital thermometers, or even traditional thermometers. There are several things to consider when conducting a mapping exercise.

Ensure that when the mapping exercise is conducted the warehouse is in same condition as it will ultimately be used to store items as:



- If the warehouse is meant to use air conditioning or other cooling solutions, ensure all temperature controls are enabled and running at the time of the mapping exercise. Note: agencies may wish to map the temperature of the facility without power as well to understand what conditions may be faced in case of a catastrophic power outage
- If the warehouse relies on passive cooling, ensure that conditions match the planned storage conditions, including all shading in place and all doors and windows are closed.

For small storage spaces (single rooms with low ceiling):

- Take a temperature reading at each of the four corners of the storage space.
- If the rooms are longer than four meters, then take a temperature reading along the edges of the floor and ceiling, with readings conducted once every two meters.

For large storage spaces, or locations with high ceilings:

- Take a temperature reading at every two- or three-meter interval both horizontally and vertically. Readings may not necessarily be conducted against a wall or surface – imagine the storage space is filled with invisible cubes of two to three meters in width stacked neatly on top of each other – temperature readings would be conducted at the corners of where each of these cubes intersect.
- If there are wide open areas where no cargo will be stored, it may not be necessary to take a reading – focus on known storage areas such as elevated racking, shelving, and packing/condition areas.

For all storage locations:

- Temperature readings should be recorded into a report or table.
- Temperature readings should be taken at multiple times a day, including in the morning, afternoon and nighttime. Ideally, temperature mapping should also occur during different times of the year, however this may not be possible for a number of practical reasons.
- If there are extreme temperature fluctuations throughout seasons, mapping should be conducted at different times of the year corresponding to seasonal changes.

The outcomes of a mapping exercise will inform how cargo is stored. If there are known areas with significant temperature spikes:

- Managers can be instructed to not store sensitive items in specific areas of the facility.
- Managers can identify potential airflow issues that may be the cause of temperature variations, such as placement of doors.
- Agencies can invest in infrastructure upgrades, such as improved powered cooling equipment or passive cooling techniques such as insulation or shading.
- Planners may choose to simply find another storage facility that is more appropriate for their needs.

## Temperature Monitoring

Temperature monitoring is the process of continually monitoring temperature inside of a warehouse or storage facility using some form of recording device. Temperature monitoring can be both automatic, and manual.

All storage locations used to store time temperature sensitive temperature-controlled health commodities – whether they are freezer rooms, cold rooms or regular temperature regulated storages – should have some form continual monitoring of temperature. If there are

specialised packing and loading spaces that are dedicated to health items, they should be monitored as well. In high capacity warehouses this can be an alarm based automatic notification when temperature deviates outside of the set range. More likely in a humanitarian environment it will either be tracked with a wall mounted thermometer or handheld thermometer with daily checks. It is recommended that daily checks are taken at different times to identify possible temperature diversions at different times of the day.

It is important to note that temperature monitoring devices (including thermometers, freeze indicators, temperature recorders, alarm systems, event loggers and remote communication devices for monitoring temperatures at all levels of the cold chain) are internationally regulated by WHO PQS. Any use of electronic or automatic temperature monitoring should be done in line manufacturer specifications, including calibration, installation and routine use. Consult the manufacturer and/or qualified installer for more information before attempting to install or calibrate devices without professional support.

### **Automatic Monitoring**

Automated temperature monitoring solutions are considered ideal for storage of temperature sensitive health commodities and should be utilised wherever possible.

## **Temperature Loggers**

A temperature logger is a standalone device that continuously records temperature on an ongoing basis. Loggers are frequently used while shipping temperature-controlled items, however they may be used to record temperature in remote locations or locations with poor infrastructure.

Temperature loggers come in multiple varieties, including those that require persistent connection to external power, and those that can run off battery power for extended periods of time. Battery powered loggers might work for makeshift storage locations in remote areas, however most loggers require data to be downloaded in a proprietary format. This means that on a regular basis or prior to dispatch of the item, the temperature logger would need to be read to ensure no deviation in temperature has occurred. Some temperature loggers are single use, and others are multiple use.

Additionally new technology for temperature loggers is always under development. Temperature logger stickers are being used by many humanitarian agencies, readable by mobile phones, with cloud-stored datalogger information.

---

## **Active Monitoring Devices**

Active monitoring devices are specialised equipment that both continually record temperatures and transmit temperature status in real time. Active temperature monitors are ideal in scenarios where temperature regulated items are stored in closed rooms that aren't accessed all the time, or when more than one temperature control facility is in use, but active monitoring devices can be used in any warehouse where temperature monitoring is required.

Active monitors come in a variety of formats, and the way they provide data come in a variety of interfaces. It is advisable that humanitarian agencies interested in using active monitoring devices find devices that:

- Can work both with and without external power (in case of power failure).
  - Have the ability to provide alerts when predefined temperature ranges are met.
  - Don't require fees or subscriptions for using software associated with the devices.
-

In an ideal setting, active monitor devices should be placed throughout the entire warehouse facility. The [WHO Expert Committee on Specifications for Pharmaceutical Preparations](#) suggests that electronic temperature monitors “should be arranged in a grid fashion along the width and length of the area so that the area is reasonably covered, [...] located every 5–10 meters.” However, many humanitarian operations function in less than ideal conditions, and the [WHO guide on Maintenance of storage facilities](#) indicates correct the correct locations are established in case of limited resources:

- Ambient and controlled ambient storage areas: Position sensors in the places where seasonal hot and cold spots have been observed during the mapping studies.
- Freezer rooms and cold rooms: Position sensors in the places where operational hot and cold spots have been observed during the qualification and/or mapping studies.

The overall layout and number of electronic monitoring devices will depend on the size of the space, and on the resources available to the humanitarian agency. General rules to consider:

Condition	Ceiling less than 3.5 meters high	Ceiling greater than 3.5 meters high
Limited number of monitors	Place monitors near the highest part of the wall, approximately 0.5 meters from the ceiling. Repeat at 5-10 meter horizontal intervals.	Place one monitor near the highest part of the wall, approximately 0.5 meters from the ceiling, and then another sensor near the midpoint of the wall, at Repeat at 5-10 meter horizontal intervals.
Capacity for multiple sensors	Place one monitor approximately 0.5 meters from the ceiling, and then another at 1.2-1.5 meters from the ground. Repeat at 5-10 meter horizontal intervals.	Place one monitor starting at 1.2-1.5 meters from the ground and add additional sensors every 2 meters up the wall until reaching approximately 0.5 meters from the ceiling. Repeat at 5-10 meter horizontal intervals.
Storage facilities with extreme temperature ranges	Consider placing monitors starting at 0.2 meters from the floor if extreme temperature changes are expected.	

Installation of automatic temperature monitors should take into account alcoves or irregular warehouse shapes. If more monitors are required because of lack of airflow or increased ambient heat in some areas of the facility, consider placing available monitors in those locations over wide-open areas with consistent temperature ranges.

Whatever active monitoring devices are used, ensure that:

- Humanitarian personnel using the devices are fully training in using and reading the equipment.
- The devices are in good working order, and if possible, covered under a warranty.
- Installed by knowledgeable persons. If no person working for the humanitarian organisation is capable of managing the install, utilise an outside service such as the warehouse provider or a private company.
- There is a plan to check on and service the devices at a period defined by the manufacturer.
- The automatic monitoring systems should provide a readout via software or website that is easy to understand, and ideally in a language spoken in the local context.

The below arrows indicate the potential locations for temperature monitoring devices.

*Temperature monitors in warehouse with elevated storage:*

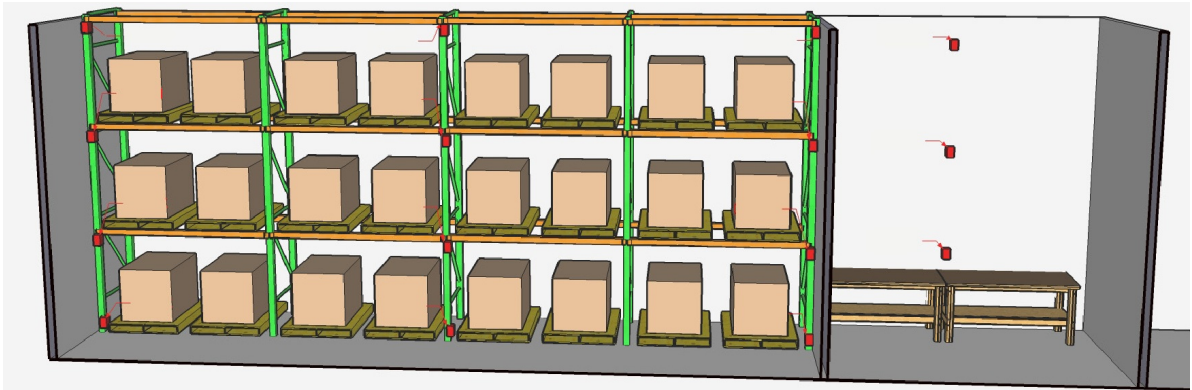

*Temperature monitors in walk-in cold storage room:*

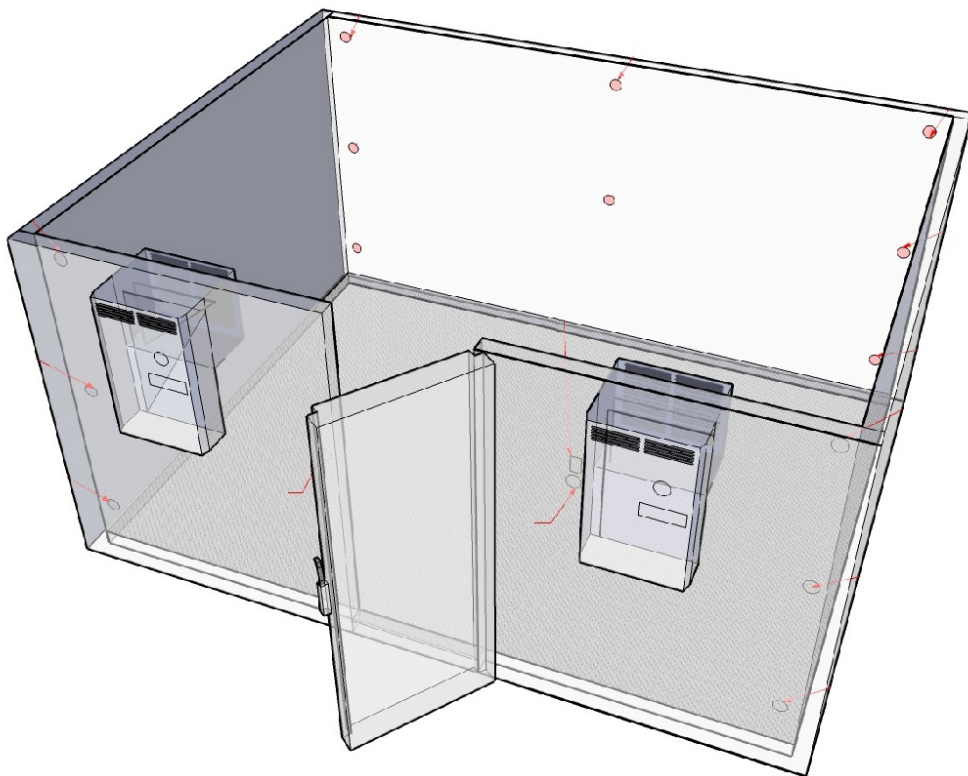

Source: [WHO - Temperature mapping of storage areas](#)

## **Manual Monitoring**

Manual temperature monitoring of health commodity storage spaces has been practiced for years and was prevalent in most locations until automated monitoring systems became more widely available. Even with advanced monitoring systems, manual monitoring is still used in many humanitarian settings, especially in rural areas, or in areas with heavily impacted infrastructure.

The concepts behind manual monitoring are not dissimilar to those of the automated monitoring systems:

- Self-powered digital, non-digital, or non-powered thermometers can be hung at intervals throughout a climate-controlled storage space and will need to be checked on an ongoing basis.
- Electronic handheld temperature readers can be used to manually check temperature readings in storage locations. This involves holding the manual temperature reader in different locations of the storage facility and recording the temperature at regular time intervals.

Manual temperature monitoring routines are better suited for smaller storage facilities equal to a single room or a small storage site. Attempting to manually track temperatures in large warehouses, or storage facilities with ceilings taller than 3.5 meters may not be feasible.

To facilitate manual monitoring, storekeepers should set a routine, ideally checking two times a day. To make things easier, if there is more than one thermometer in the storage facility, the storekeeper should record the highest temperature found in the room – trying to maintain records on every thermometer may be difficult and confusing. At a minimum each separate space – such as room or dedicated area of the warehouse - should have its own manual monitoring chart. Ideally, in large warehouse rooms multiple manual monitoring charts should be used, particularly if using multiple different active cooling systems, or where one side of the room is more exposed to possible deviations in temperature, such as an open loading door.

Below is an example manual monitoring chart:

Cold room/refrigerator number: <input type="text"/>		Start date: <dd/mmm/yyyy> <input type="text"/>		Key: FI = freeze indicator (status OK or X)																												
Equipment model: <input type="text"/>		Location: <input type="text"/>																														
Day		1	2	3	4	5	6	7	8	9	10	11	12	13	14	15	16	17	18	19	20	21	22	23	24	25	26	27	28	29		
Temperature chart	°C	am	pm	am	pm	am	pm	am	pm	am	pm	am	pm	am	pm	am	pm	am	pm	am	pm	am	pm	am	pm	am	pm	am	pm	am	pm	
	+16																															
	+15																															
	+14																															
	+13																															
	+12																															
	+11																															
	+10																															
	+9																															
	+8																															
	+7																															
	+6																															
	+5																															
	+4																															
	+3																															
	+2																															
	+1																															
0																																
-1																																
-2																																
-3																																
-4																																
-5																																
FI (X or OK)																																
>=8 °C alarm	Once every 24 hours, enter high alarm status and maximum temperature recorded by the continuous temperature monitoring device																															
Alarm time or OK																																
Maximum °C																																
< -0.5 °C alarm	Once every 24 hours, enter low alarm status and minimum temperature recorded by the continuous temperature monitoring device																															
Alarm time or OK																																
Min °C																																
Initials:																																
Province:	<input type="text"/>					Month:	<input type="text"/>					Remarks:	<input type="text"/>																			
District:	<input type="text"/>					Year:	<input type="text"/>																									
Health centre:	<input type="text"/>					Supervisor:	<input type="text"/>																									

Taken from: [immunizationacademy.com](http://immunizationacademy.com)

Once each monitoring chart has been completely filled, it should be backed up in a binder and stored in a safe location – this will enable planners and managers to look at historical trends and identify potential problems with individual storage facilities.

Title

Download - Template Temperature Monitoring Chart

File



## Cold Rooms and Freezer Rooms

Cold rooms and freezers rooms are typically custom built and meant to store cargo items that occupy traditionally low temperatures. This includes products below freezing temperatures, as well health items that occupy the +2°C to +8°C range. Rooms with cold storage or freezer capacity typically are custom built for the storage requirement, and are subject to higher degrees of control, such as continuous monitoring capacity or redundant power systems. Cold and freezer rooms also require specialised equipment and insulation.

In the majority of operations, items requiring storage below +8°C usually make up a small portion of the overall volume of cargo items, and properly calibrated cold storage rooms often don't need to be large, and ideally should only match the actual known requirements. In many cases, a standalone electric refrigerator/freezer will meet the storage requirements for most agencies. Cold storage rooms can represent a substantial financial investment and given the duration of both emergencies and available funding, such rooms are typically only planned when either the volume of the incoming cold storage items are substantial, or when the duration of project is known to be long.

*Walk-in cold room:*

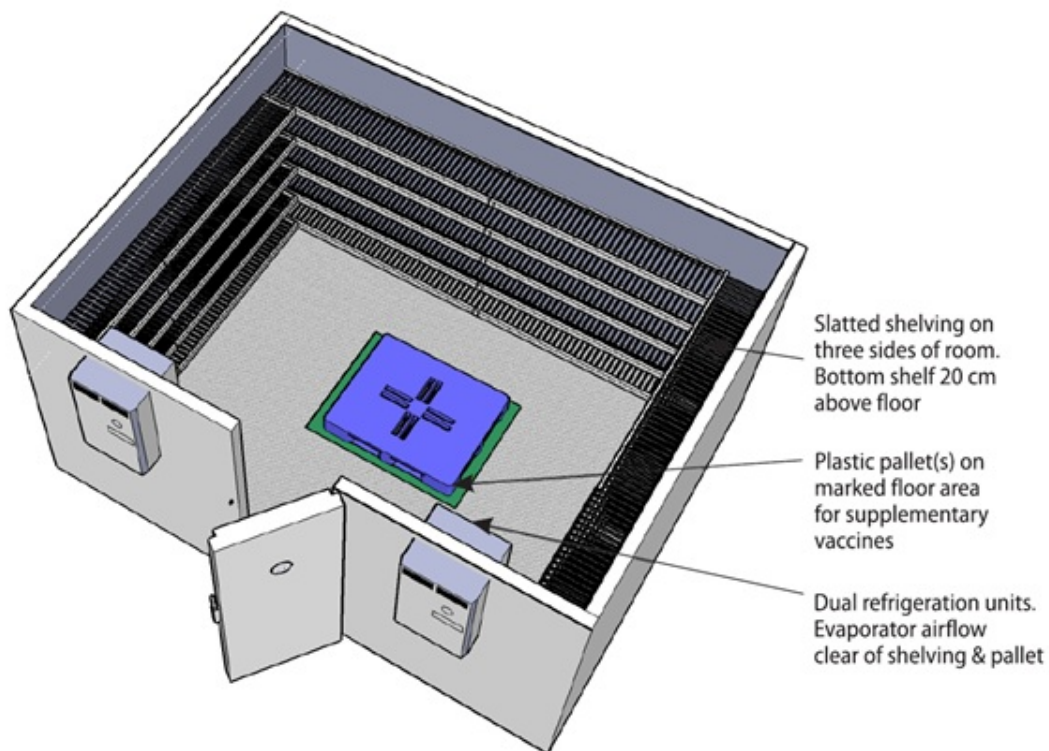

In instances where humanitarian agencies require large, or even warehouse sized refrigerated storage, it is strongly suggested that agencies speak with a licensed professional or attempt to outsource the storage space to a third party commercial provider. Large scale refrigerated storage or refrigerated warehouse spaces are fairly common amongst large manufacturers, or amongst national authorities, and their overall functioning is not dissimilar to smaller refrigerated storage spaces, however the costs and complexities associated with constructing and maintaining these facilities should only be overseen by experienced professionals.

In addition to industrial scale refrigeration, other features of refrigerated warehouses might include:

- A kitting or packing area – an area used to assemble pallets or kits that is also contained within a refrigerated space.
- Specialised doors/loading bays – doors and loading bays will have proper insulation, plastic flaps, or even specially designed fans to prevent heat loss through openings to the external world.

*Temperature-controlled pallet standing storage area:*

### Pallet standing store

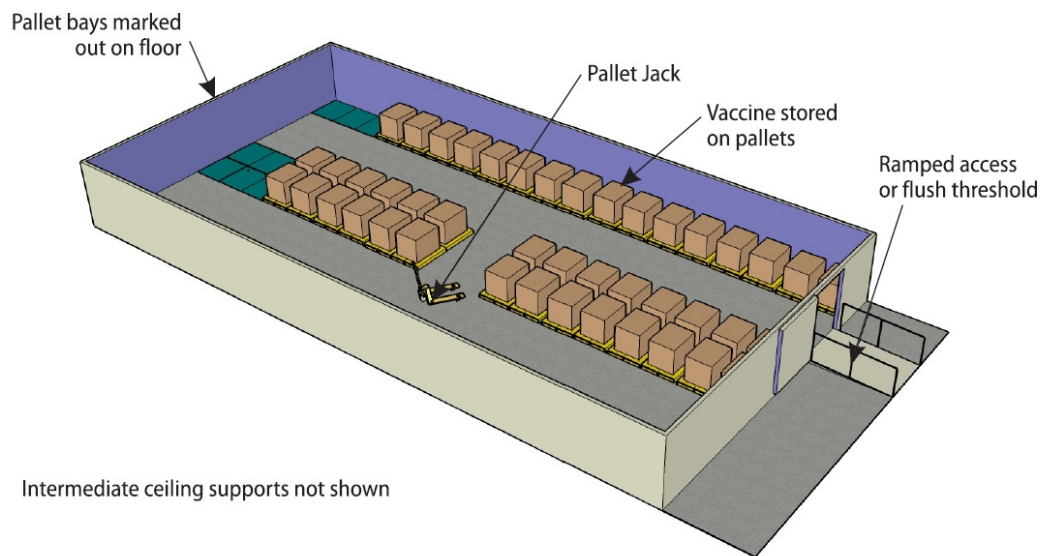

*Temperature-controlled elevated racking storage with kitting/order assembly:*



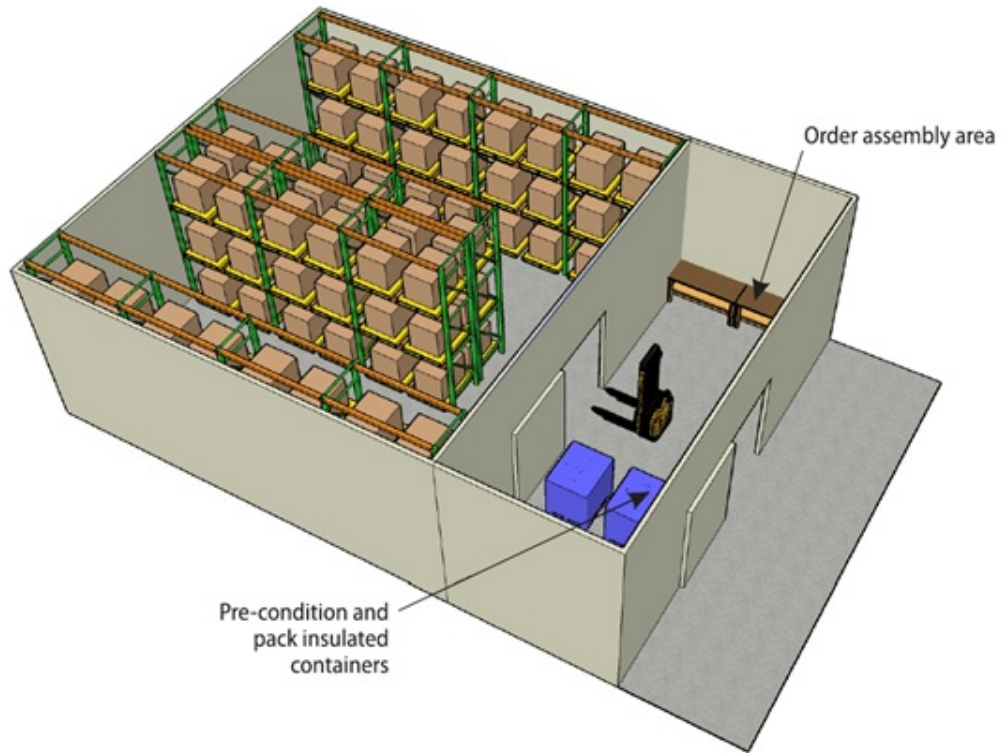

*Temperature-controlled dock seal:*

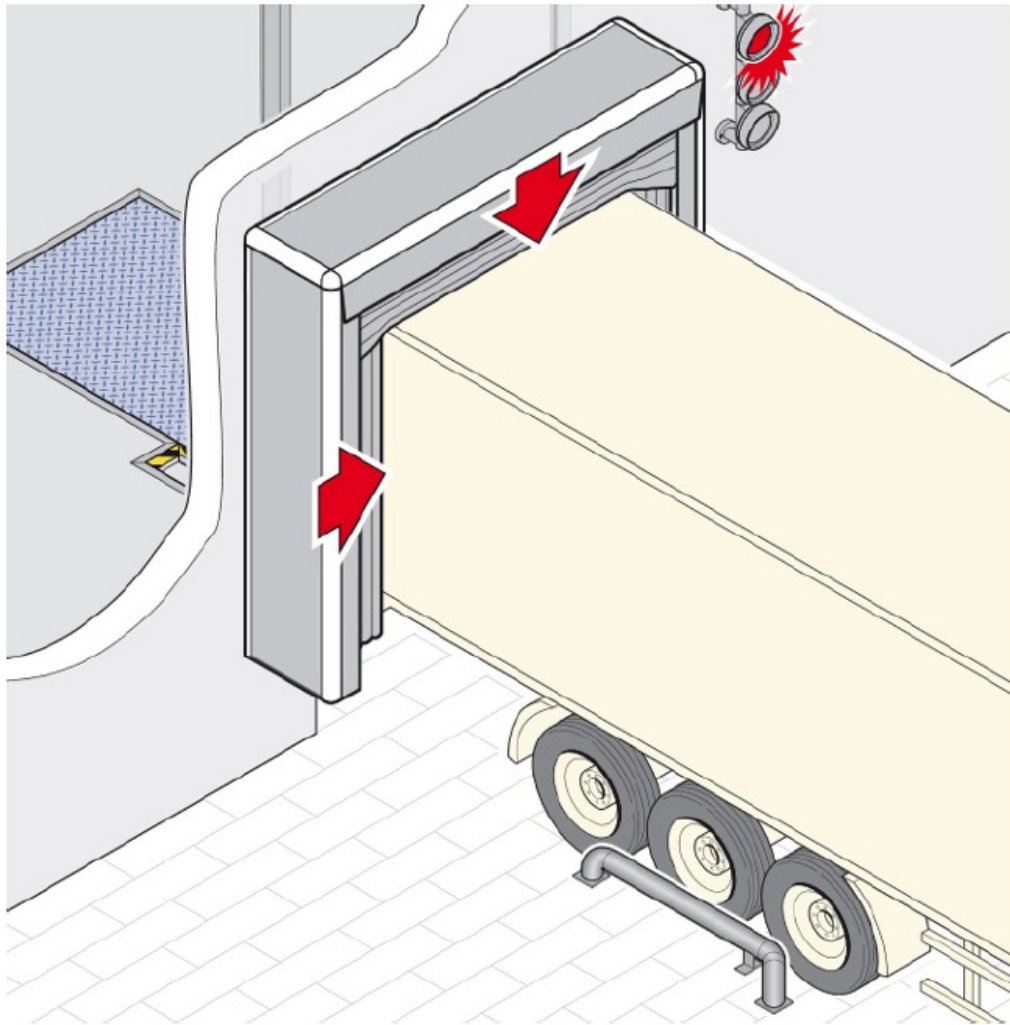

Taken from: [WHO - Design and procurement of storage facilities](#)

## **Stand Alone Refrigerators and Freezers**

Some health commodities and some humanitarian health related storage needs may only require the usage of stand-alone freezers or refrigerators. Refrigerators and freezers tend to be useful for vaccines and other small volume pharmaceutical items, as the capacity of refrigerators is relatively small. However, refrigerators and freezers are good alternatives when the known quantities of stored items will be low volume, or when no other alternatives are available. Additionally, standalone refrigerator and freezers may be required for ice and cool packs if reconditioning of passive cold chain boxes is required.

Much like air conditioners, refrigerators and freezers also produce heat exhaust. If refrigerators/freezers are kept inside of a warehouse facility, there should be proper ventilation to avoid excessive heat built up, and planners should be aware of the impact increased temperatures might have on other collocated stocks. In instances where multiple freezers and/or refrigerators are in the same storage location, this may become a problem requiring dedicated attention.

## **Configurations for Refrigerators and Freezers**

Though only basic equipment may be available in many field contexts, there are still special configurations that humanitarian organisations maintaining cold chain medical items may wish to consider.

**Medical Grade Refrigerators/Freezers** – There are a variety of medical grade freezers and refrigerators that are purpose built for maintaining keep cool and frozen grade medical items. Medical grade refrigerators and freezers are internationally regulated by WHO prequalification. Some characteristics of these refrigerator/freezer units might include:

- Highly calibrated thermostats/cooling units.
- Clearly defined set points.
- Back up battery systems in case of power failures.
- Alarm systems in case of temperature excursions.
- Clear windows to make identifying contents easier without having to open doors.

Specialty freezers and refrigerators are often also right-size, designed to only accommodate the anticipated demand of those specific temperature ranges, meaning they can be purchased in relatively small sizes, and different temperature requirements can be stored in different units.



Wherever possible, humanitarian organisations should avoid regular consumer grade refrigerators and freezers for any health items that have highly specific temperature ranges, or for health items that can be easily damaged by excursions. For example, vaccines tend to have a very low threshold for temperatures above/below defined ranges, and without clearly defined set points or precise monitoring a regular consumer grade freezer may not be sufficient.

If agencies plan on using regular consumer grade freezers or refrigerators, they will want to thoroughly assess the capacity of the units, including:

- Logging temperatures inside the for 5-7 days *prior* to storing temperature-controlled items to ensure that temperatures remain consistent and within the anticipated ranges. Monitoring should be done the same as a temperature-controlled warehouse –

temperatures logged once every few hours.

- If possible, agencies should use temperature loggers inside refrigerators/freezers to map any temperature excursions for functions.
- Install a universal power supply (UPS) with an alarm system in case of power outage.

**Top Loading Refrigerators/Freezers** – A common method for conserving power/preventing heat loss is the use of top-loading refrigerators and freezers. Top-loading units open from the top instead of the side – as cool air sinks downward, there is less of a chance of cold air escaping, maximising energy for the refrigerator or freezer. Much like consumer grade units, there are also medical grade top-loaded refrigerators and freezers that should be considered when procuring.



## **Persistent Power**

Refrigerators and freezers require access to consistent power, especially when storing vaccines. Due to the fact that persistent power isn't always available in all field locations where humanitarian actors may be operating, there are a variety of power options that should be considered.

**Compression Refrigerators: Plug-in Power** – Basic refrigerators and freezers will come in plug-in models only, not dissimilar to those used in home settings. Some freezers and refrigerators specifically designed for management of vaccines and other medical commodities may come with built-in battery backup systems that enable the units to continue to maintain active cooling for periods of intermittent power outage. Built-in power backups generally won't provide power longer than a few hours, and users should consult manufacturer guidelines and compare against anticipated power outages in the areas of storage.

**Absorption Refrigerators: Kerosene/Gas Powered** – Completely off-grid refrigerators and

freezers traditionally have been powered with Kerosene and other forms of combustible gas. Gas powered refrigerators/freezers are typically powered using compressed gas cylinders or liquid gases – the gases are used to ignite a pilot light that heats permanently sealed coil that is chemically designed to produce a cooling effect. Gas powered refrigerators – though widely used – have slowly become less common due to the health risks and fire hazards associated with their use. Additionally, gas powered freezers/refrigerators will still require a supply of fuel, any disruption of which will cause the units to stop working. Depending on the size of the gas cylinder or the refrigerator units, gas powered refrigerators/freezers may need to be monitored and changed frequently.



**Solar Powered** – As costs of batteries and solar panels have gone down, the use of solar powered refrigerator units has increased in many remote areas. The basics of using solar power for refrigeration are no different than the basics of using solar for any other electrical appliance. For more information, please reference the sections on [solar powered systems](#) and [battery backup systems](#). The important things to note when using solar and battery systems for refrigerators and freezers is that refrigerators/freezers rely on electricity, and that the power is sufficient to match the consumption needs of the units – freezers and refrigerators tend to use a large amount of electricity, especially in warm climates.

In many cases, humanitarian organisations may wish to install solar panels and/or batteries specifically for standalone freezers/refrigerators; many manufacturers produce self-contained solar powered freezers and refrigerators that humanitarian organisations may buy. When investigating solar powered or battery backup supported freezers/refrigerators, it's important to note the difference between "Solar direct" power and "solar battery power".

- Solar Direct Power – the refrigerator/freezer is linked directly to the solar panel without any intermediary battery, meaning there is no electricity produced while the sun is not directly shining on the panels. Refrigerators/freezers that don't have built in battery backups will experience power outages during the nighttime.
- Solar Battery Power – Solar battery powered freezers/refrigerators have a regulated battery system in between unit and the solar panels, allowing the batteries to absorb power through the day and slowly disperse it through the night. A properly designed

battery backup system will accommodate the full need of the refrigerator/freezer, without any breakages in power, even during emergencies. A battery backup system should still have [sufficient safety controls](#), like any battery system in use.

#### Solar Battery Powered Refrigerator

#### Solar Direct Refrigerator

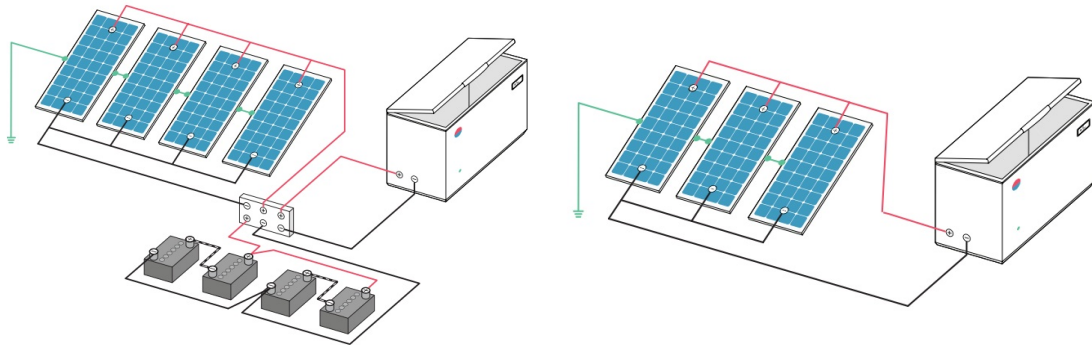

Taken from: [WHO - Solar direct-drive vaccine refrigerators and freezers](#)

In the event of persistent power outages/power shortages with no alternative provided for backup power, protocols should be put in place to ensure that goods stored within refrigerators and freezers maintain internal temperature during outages. This might include:

- Instructing staff to not opening the units while power is out.
- The use of temperature dataloggers.
- Using ice and cool packs to augment temperature controls.

### Maintaining freezers and refrigerators

Refrigerators and freezers will degrade over time. Signs of degradation might include:

- Condensation or ice forming on the outside of the refrigerators.
- The compressor motor used to generate cooling runs for noticeably long or frequent periods of time.
- The interior of units never become cool, or reach a given set point.

Suggested maintenance procedures for medical grade refrigerators and freezers include:

- Keep units clean by regularly washing with mild soapy water solution.
- Keep door seals clean, avoiding build-up of material between folds and at corners.
- Remove build-up of ice (use the defrost system or a blunt scraper).
- Keep drains free of debris.
- Clean condenser coil (fins), ensure fins and cooling fan and any grilles are free of dust, fluff and debris.

### Physical Management of Health Supplies

The storage and physical management of health items should follow most of be standard basic principles of [warehouse](#) and inventory management. In addition to basic standards, there are a few additional factors to consider when storing health items.

## Organising Health Items

The arrangement of health items in a warehouse or a storage room can take multiple forms. In large scale warehouses, or warehouses where cargo items are palletized, traditional methods for arranging cargo will usually be sufficient, provided that temperature, humidity and light exposure requirements are met.

In many cases however, health items are stored loose, or broken down into much smaller accounting units. Due to the relatively small volumes of health items, and to the relatively high number of individual line items, health items are frequently stored on shelves, segregated by individual units. Segregating by individual units also makes it easier to distribute relatively smaller quantities of items that may only be consumed in smaller proportions.

### “VEN” Storage

In medium to large sized storage facilities and storerooms used to store medical items, health items can be segregated by the risks associated with being exposed to temperature fluctuations, by the frequency or importance of use, and by the control requirements in place. “VEN” storage is defined as prioritizing storage locations for items based on if they are defined as:

- Vital (V)
- Essential (E)
- Nonessential (N)

Similar to the [zonal strategy of segregating items based on their weight and overall frequency of usage](#), the VEN method helps identify the physical location in a warehouse where cargo items should go by placing cargo in categories that should be co-located together in storage locations. VEN storage analysis will help design the layout of storage facilities, identifying:

- Where the most temperature sensitive cargo should be located.
- Where specialty items, such as narcotics, psychotropics, or other heavily regulated items should be located.
- Where frequently used items should be located.
- Where extremely fragile items should be located.

### Product Characteristics

Another method of organising and storing medications and medical relief items is segregating items by product characteristics. Arbitrary segregation is useful for quickly identifying medical items and may be especially useful in warehouses with high numbers of SKUs. In some cases, more than one sorting method can be used at the same time, such as first segregation items based on characteristic (project) and then segregating those subcategories by another characteristic (alphabetical).

**Dosage Form** – One of the most frequent methods of organising stock on racks and shelves is segregating items along the physical characteristics of their dosage form. Dosage forms might include:

- Pills
- Injectables
- Liquid consumables (Example: syrups)
- Topical (Example: creams)

The advantage of segregating by dosage form is that frequently similar dosage forms will have similar handling requirements. As an example, injectables frequently come in glass vials that should be handled as fragile items.

**Alphabetical** – In environments in which warehouse employees may not have special knowledge of health items, segregating and storing items alphabetically based on their generic names will enable rapid identification of storage locations. Alphabetical storage only works best in storerooms with:

- Limited or no difference in temperature controls for different items in stock.
- Smaller storerooms without large variables in temperature or large volumes of SKUs.
- Storage environments where there is a commonly understood primary language.

**Frequency** – [Much like zonal storage plans for bulk cargo](#), some planners may want to arrange stock items in a warehouse based on their frequency of use. This would include placing the most frequently used items on shelves or racks closer to doors, and near the front of storage rooms.

**Pre-defined Coding** – Humanitarian organisations responding to any health emergency may have a variety of methods and reasons for defining their own coding systems. These coding types might include:

- Project or donor – segregating items based on the project for which they were purchased, and for which they must be used.
- Regulation – some local or national authorities might have their own commodity coding system based on prevailing health regulations.
- Inventory Management Systems – If humanitarian organisations already have their own inventory management systems that can assign categorization to many things, including health items.

## Secure Storage Areas

Wherever pharmaceuticals are stored and transported, there may be specialty “controlled substances” that require secure storage. Items requiring secure storage might include:

- Items of high value.
- Items that have a high risk of addiction or substance abuse.
- Items that are specifically regulated under local or national laws.

As a general rule, any item that is classified as a narcotic, a psychotropic, or some other form of analgesics drug should be placed in secure storage, with two-step access as preferred option. In many cases National Essential Medicines Lists will outline any drugs that require secure storage under national laws. In some cases, humanitarian organisations may be completely banned from storing certain items.



	<b>Narcotics:</b> <i>morphine, opium preparations, pethidine, diamorphine, papaveretum, hydrocodone and oxycodone, dipipanone, and tramadol.</i>
<b>Examples of Common Controlled Substances:</b>	<b>Other opioid and strong analgesics:</b> <i>pentazocine, codeine, dihydrocodeine, dextropropoxyphene, dextromoramide, and buprenorphine.</i>
	<b>Psychotropic drugs:</b> <i>usually the group of drugs called "benzodiazepines," the more common being diazepam, temazepam, nitrazepam, flunitrazepam, and oxazepam. Clonazepam, used to treat epilepsy, may be found under a different class, and is not always under the same control. Strong tranquilizing medicines, such as chlorpromazine, may also be found under this heading.</i>

---

---

Taken from: JSI Deliver [Guidelines for the Storage of Essential Medicines](#)

Any item requiring secured storage must be safely and adequately stored in an appropriate location. Depending on the volumes of the controlled substances and the available space in the storage facilities, secure storage might include:

- A room with lockable doors.
- Locking caged shelving or racking.
- A locking safe, securely attached to a permanent surface.

The advantage of a separated room with lockable doors is that it may be regulated to its own temperature when required for the commodity items. In many cases however, controlled substances must be kept in the same open general space as the rest of the commodities in the warehouse. Where controlled substances are kept in the same location as general cargo, organisations may use caged shelving or racking:



Caged racks/shelves should be lockable and should be sturdy enough to avoid being broken into easily.

General rules for maintaining a secure storage location include:

- Keys should only be assigned to authorized personnel. Ideally, a responsible warehouse manager will control access to the warehouse, while only staff authorized to access the controlled substances storage location within the warehouse will hold keys to the lockable storage location. In some countries, the persons with access to keys to lockable items must undergo a licensing procedure.
- Stock card should be used in all scenarios, including a sign out sheet requiring personnel to sign as items are removed.
- Where available, an alarm system should be used.
- Where available, a camera system with recoding capacity should be installed, especially in scenarios where large volumes of controlled substances are stored.

### **Other Planned Spaces**

In addition to other specific infrastructural requirements for warehousing and storing health commodities in a humanitarian context, logistics planners should also consider planned spaces for key activities.

**Receiving/Dispatching** – warehouses of sufficiently large sizes ideally should have special demarcated areas specifically for goods that have either just arrived or are being consolidated for dispatch. In many storage facilities, the loading/receiving areas are either right next to loading bays/doors, in an intermediary chamber, or even possibly outside the storage facility. When designing a loading/receiving area, planners must consider the need for temperature-controlled cargo and health items; much like temperature-controlled storage spaces, areas specially designated to for dispatching/receiving should also be temperature-controlled wherever possible. Additionally, dispatching areas may also have space specifically set aside for packing keep cool boxes if required by needs of the project.

**Quarantine Area** – see section “[Damaged and Expired Health Items](#)”.

**Kitting Area** – Kitting areas are common in humanitarian warehouses; however, kitting of health items may require special attention. Areas used to kit health items including pharmaceuticals and medical devices may require extra attention; areas used to kit health items should be thoroughly cleaned and may require temperature-controlled work areas to maintain proper conditions for the items. Kitting may take hours or even days depending on the work order, and the kitting area should be as appropriate for storage of health items as the main storage facility.

## General Storage Guidelines for Medical Items

In any storage location where health items might be stored, there are several general rules that will help avoid loss to stock through damage or unanticipated expiration date.

### Item Placement and Visibility:

- Avoid storing boxes, or exposed health items in places that receive direct sunlight. Even short periods of exposure to sunlight can damage some health items, especially those labelled as light sensitive.
- Unless there is an advanced inventory management system in place, [stock cards are strongly recommended](#). Stock cards should contain information on:
  - Batch numbers.
  - Expiration dates.
  - Temperature ranges.
  - Product codes.
  - Programmatic use.
- Avoid mixing the same medication from different batches/expiry dates – if your storage facility is warehousing the same health item but from different batches/expiry dates, those items should be kept separately, and recorded separately.

If storing health items in cartons:

- Ensure that cartons with arrows indicating which side should be facing upward are properly followed.
- Ensure cartons are properly labelled, with contents, expiration dates, batch, and other relevant information visible. If no labels are used, or the boxes come unmarked, write the relevant information on the side.
- Follow manufacturer's directions on stacking and handling.

It is always important to remember that the majority of health items are classified as fragile. Handling personnel and practices should be in place to ensure safe management of goods.

Any storage facility used to store health commodities protect all items from physical damage, moisture, excessive heat or cold, sunlight, dust, dirt, and pests. Cleanliness in a warehouse used to store medical items is of even more importance than it is for some other categories of commodities.

**Colocation with Other Materials** – Pharmaceuticals and medical support devices should always be stored separately from chemicals or food. Examples of chemicals commonly found in humanitarian contexts might include:

- Pesticides
- Fertilizers
- Cleaning agents

- Fuel
- Foodstuffs and bulk food items

However, even non typically hazardous materials – such as bags of cement – can impact health items, both in storage and in transport. Wherever possible, health related items should be stored in adequately prepared and separated spaces.

### **Shelving:**

The use of shelving is very common when managing health items. Shelving is useful for easily storing small quantities of a large number of SKUs, enabling storekeepers to withdraw discrete quantities of items while still being able to neatly segregate and track them.

Frequently shelving is used in the same location as racking; racking is better suited for managing large cartons or pallets and may be used before the cartons are open and the line items are broken down into discrete inventory units, while shelving is better suited for managing individual units that are withdrawn on a case by case basis. Both have their use cases in health facilities.



In addition to the [normal practices of using shelves](#), there are some special considerations when using shelves to store health items:

- Place glass vials on the bottom shelf to minimise risks of damage from falling items.
- Place liquids on the bottom shelf to avoid damaging other items in case of a rupture or leakage.
- Ensure that all items are clearly visible, and when labelled, labels are legible.
- Even if the quantities are small, use stock cards to record transactions. Multiple stock cards can be kept in a single pouch or container to save space.
- In storage areas with temperature zones, temperature sensitive health items should be stored where temperatures are most appropriate for their manufacturer specified requirements, usually on the lower shelves.

### **Palletisation:**

If health items are stored in pallets, there are some key rules for proper management beyond the regular guidelines for [managing pallets](#) and [ground stacking](#):

- All cartons containing health items should be clearly labelled with relevant information, and labels should be outward facing and visible.
- Medications are frequently light, and sub-packaging may have much empty space – cartons containing health items might be easily crushed or damaged and should not be stacked to excessive heights. Never exceed 2.5 meters as a maximum height of cartons stacked on a pallet, and ideally less height where possible.
- When storing pallets with multiple types of health items, pallets may need to be physically separated by a minimum of 30 centimetres to allow access to all sides of the pallet for inspection and handling purposes.
- Where possible, store like-items together, such as health items from the same batch and with the same expiration date. Intermixing different items will make picking specific items more difficult.
- The use of heat treated, or plastic pallets is recommended for storing health items wherever possible.

## **Damaged and Expired Health Items**

Due to the sensitive nature of pharmaceuticals and other medical devices, it is extremely important that managers of health stores monitor, identify and isolate damaged or expired items for proper repair or disposal and prevent accidental release of such items into distribution to avoid harm to end user.

Managers of health items should always track the expiration dates of health items, and routinely conduct [inspections and physical inventory counts](#) to ensure any and all instances of expiration or damage are captured. The intervals required for inventory counts of health items may be more frequent than non-medical items, and managers may wish to conduct a physical inventory every three months or even once a month. Based on the number of individual line items in any medical store, a full physical inventory may be prohibitively complex, so managers may also wish to conduct random sampling on an ongoing basis, with intermittent physical inventories through the year.

Health items that have been identified as either damaged or expired should be removed from their regular location in the storage space, and isolated in a specially identified “quarantine area” within the storage facility. A quarantine area doesn’t mean that health items are infectious, but rather they are to be treated separately from the rest of the items on stock. Quarantine areas should be:

- Clearly marked and labelled as being stock that cannot be issued as regular stock.
- Clearly physically separated from main stock items. This might include painted areas on the floor, or possibly even separate rooms.
- Ideally, quarantine areas should be lockable, and keys should be kept with the warehouse manager.
- In some contexts, the isolation and management of damaged/expired health items might have specific regulations, including secure monitoring and time limitations. Logistics personnel should consider local laws prior to designing a quarantine strategy.

Items placed in quarantine should:

- Be tracked separately from non-impacted stock items, including their own stock cards and their own record in an electronic inventory system.
- Be prepped and ready for disposal.

- Any medication, be it expired or damaged should not be considered fit for human consumption and should be disposed of safely and in a manner in compliance with local regulations. Please reference the section on [medical waste management](#) for more information.

## Inventory Management of Medical Items

The process for the proper management of health items should follow the general guidelines for [all inventory management](#), including overall [demand forecasting](#) and [inventory control mechanisms](#). There are – however – additional concepts that are special to managing health items.

### First Expired/First Out (FEFO)

FEFO as a general rule is important for health products because it emphasises expiration dates of products, irrespective of when those items may have entered general storage. In FEFO, products are rotated out of storage based on how close they are to expiration. In health supply chains, there may be multiple products of the exact same type that happen to have different production/expiration dates; FEFO helps reduce product loss by ensuring that wherever possible, the shortest shelf-life items are used first.

In order for FEFO to be effective:

- Expiration dates should be clearly identifiable on products held on shelves and racks. If the expiration date cannot be easily seen on the carton or packaging, then the expiration date may be noted on stickers or pieces of paper on the outside of the cartons/pallets.
- Expiration dates should be recorded on all stock cards and warehouse ledgers/inventory systems.
- Similar items with different expiration dates should be separated by expiration dates. Where possible the items with the closest expiration dates should be moved to the front of racks or shelves, something that might be more useful in smaller storage facilities with loose items on shelving.
- Physical inventories should be conducted routinely, with an emphasis on identifying short shelf-life items that may have been ignored or intermixed with other stock items.
- Persons managing inventory should be told to issue short shelf-life items first wherever possible.
- Items approaching three to six months prior to expiration dates should be flagged. Any items with less than three months of shelf life should be communicated to project managers immediately so action can be taken as needed.

### Product Inspection

The physical characteristics of health items may change over time and may be clear signs of degradation of product quality. In addition to looking for physical damage to packaging or tracking expiration dates, there are things that logistics managers of health products might look out for to determine if a product has quality problems:

Product Type	Signs of Quality Problems
<b>All products</b>	<ul style="list-style-type: none"> <li>• Broken or ripped packaging (vials, bottles, boxes, etc.)</li> <li>• Missing, incomplete, or unreadable label(s)</li> </ul>
<b>Liquids</b>	<ul style="list-style-type: none"> <li>• Discolouration</li> <li>• Cloudiness</li> <li>• Sediment</li> <li>• Broken seal on bottle</li> <li>• Cracks in ampoule, bottle, or vial</li> <li>• Dampness or moisture in the packaging</li> </ul>
<b>Light-sensitive products (such as x-ray film)</b>	<ul style="list-style-type: none"> <li>• Torn or ripped packaging</li> </ul>
<b>Latex products</b>	<ul style="list-style-type: none"> <li>• Dry</li> <li>• Brittle</li> <li>• Cracked</li> </ul>
<b>Lubricated latex products</b>	<ul style="list-style-type: none"> <li>• Sticky packaging</li> <li>• Discoloured product or lubricant</li> <li>• Stained packaging</li> <li>• Leakage of the lubricant (moist or damp packaging)</li> </ul>
<b>Pills (tablets)</b>	<ul style="list-style-type: none"> <li>• Discolouration</li> <li>• Crumbled pills</li> <li>• Missing pills (from blister pack)</li> <li>• Stickiness (especially coated tablets)</li> <li>• Unusual smell</li> </ul>
<b>Injectables</b>	<ul style="list-style-type: none"> <li>• Liquid does not return to suspension after shaking</li> </ul>
<b>Sterile products (including IUDs)</b>	<ul style="list-style-type: none"> <li>• Torn or ripped packaging</li> <li>• Missing parts</li> <li>• Broken or bent parts</li> <li>• Moisture inside the packaging</li> <li>• Stained packaging</li> </ul>

<b>Product Type</b>	<b>Signs of Quality Problems</b>
<b>Capsules</b>	<ul style="list-style-type: none"> <li>• Discolouration</li> <li>• Stickiness</li> <li>• Crushed capsules</li> </ul>
<b>Tubes</b>	<ul style="list-style-type: none"> <li>• Sticky tube(s)</li> <li>• Leaking contents</li> <li>• Perforations or holes in the tube</li> </ul>
<b>Foil packs</b>	<ul style="list-style-type: none"> <li>• Perforation(s) in packaging</li> </ul>
<b>Chemical reagents</b>	<ul style="list-style-type: none"> <li>• Discolouration</li> </ul>

Taken from: [JSI - Guidelines for the Storage of Essential Medicines and other Health Commodities](#)

Signs of product defects can be caused by a variety of things and may be sign of a wider problem.

If any product displaying any form of above-mentioned defects is identified, logistics personnel should:

- Separate identified issues from general stock and stop any distribution or use of the items.
- Contact the product distributor and/or manufacturer and/or the organisations quality assurance specialists to see if there is a known cause or if the product may still be usable.
- Contact other storage sites or health facilities with similar products to see if the problem is occurring elsewhere.

Only after a proper course of action is identified should products be either disposed of or returned to general rotation. In the event that the product is damaged, and disposed of, mitigation measures should be implemented to prevent future damages to other items if within the control of the organisation/warehouse.

## **Recall Management**

Throughout the course of any health-related supply chain, health practitioners may be faced with managing product recalls. A product recall occurs when a manufacturer or a local health authority indicates that one or more health items is considered unfit for human consumption and must not be distributed or used in routine activities. There are multiple reasons why a product may be recalled, including faulty production, product tampering, changes to local regulations, or some other defect that may impact the product's fitness for human consumption. Manufacturer's typically reference item batch or lot numbers when identifying recalled items, however entire product lines or even products from specific periods of production may be recalled. The important part is that the manufacturer or local health authority will provide specific criteria for what items should be recalled, and humanitarian actors should endeavour to comply wherever possible.



Recalled items are occasionally returned to the manufacturer, however in many contexts the owners of the health items will need to actively quarantine all recalled items and manage the destruction/disposal process directly. In most humanitarian contexts, pharmaceuticals and medical devices are frequently imported from outside the country of operation, and the process of collecting and re-exporting recalled items may be prohibitive or even impossible. Any time a recall occurs, logistics planners must assess what is feasible.

The general steps for recall management include:

- A product manufacturer or local health authority identifies a specific product, or products based on key criteria that should be recalled.
- (If possible) humanitarian organisations should reference all procurement and inventory tracking systems to understand if the recalled items are currently in their supply chains. Note: due to the complex or ad-hoc nature of humanitarian supply chains, this information may not be available. If no records are available, humanitarian organisations should act as if they have recalled items in their possession.
- Humanitarian organisations should immediately contact all warehouses, storerooms, health facilities, or other locations where recalled products might have been sent. All locations should be informed to do a full inventory to identify any and all recalled items. Identified recalled items should be segregated from the primary inventory items and placed in a secured quarantine area.
- (If required) humanitarian organisations should contact local communities, ministry of health offices and partner organisations that might have received recalled goods as part of regular programmatic activities and inform each party of which items have been recalled, and what steps they should take to safely secure recalled items. Depending on the context, the humanitarian organisation may be required to retrieve all recalled items directly from each outside party in order to avoid any mismanagement or accidental distribution.
- (If required) The humanitarian organisation in question may have to organise the pick-up and relocation of all expired items to the capital city or primary distribution facility to enable proper return or disposal of the recalled goods. In many humanitarian contexts, there may be no local infrastructure to support disposal at the local level.
- In every context, there may be different steps required for the proper disposal of recalled items.
  - Manufacturers may offer or may be obliged to pick up recalled items directly from organisations managing the items themselves.
  - Local or national health authorities may have dedicated facilities or means to pick up or receive specific recalled items.
  - Local or national regulations may require that recalled health items be disposed of by the product owner in specific way, or that some items be re-exported. In the event items are re-exported, special permits will likely be required.

Even if there is no specific regulation in place, humanitarian organisations should seek to properly dispose of recalled items using the most ethical and environmentally friendly methods available. Proper disposal methods can be found in the section on [managing medical waste](#).

## Medical Waste Management

While supporting any form of medical intervention, logistics personnel may be asked to manage a variety of medical waste. Medical waste isn't defined as just the health items that are found as damaged or expired while in storage or transport, but also the byproduct of routine

activities that occur in health centres and hospitals as well.

Waste Categories	Descriptions and Examples	
Hazardous Health-care Waste	<b>Infectious waste</b>	Waste known or suspected to contain pathogens and pose a risk of disease transmission, e.g. waste and wastewater contaminated with blood and other body fluids, including highly infectious waste such as laboratory cultures and microbiological stocks; and waste including excreta and other materials that have been in contact with patients infected with highly infectious diseases in isolation wards.
	<b>Sharps waste</b>	Used or unused sharps, e.g. hypodermic, intravenous or other needles; auto-disable syringes; syringes with attached needles; infusion sets; scalpels; pipettes; knives; blades; broken glass.
	<b>Pathological waste</b>	Human tissues, organs or fluids; body parts; foetuses; unused blood products.
	<b>Pharmaceutical waste, cytotoxic waste</b>	Pharmaceuticals that are expired or no longer needed; items contaminated by, or containing, pharmaceuticals. Cytotoxic waste containing substances with genotoxic properties, e.g. waste containing cytostatic drugs (often used in cancer therapy); genotoxic chemicals.
	<b>Chemical waste</b>	Waste containing chemical substances, e.g. laboratory reagents; film developer; disinfectants that are expired or no longer needed; solvents; waste with high content of heavy metals, e.g. batteries, broken thermometers and blood pressure gauges.
Non-hazardous or General Health-care Waste	<b>Radioactive waste</b>	Waste containing radioactive substances, e.g. unused liquids from radiotherapy or laboratory research; contaminated glassware, packages or absorbent paper; urine and excreta from patients treated or tested with unsealed radionuclides; sealed sources.
	<b>General waste</b>	Waste that does not pose any specific biological, chemical, radioactive or physical hazard.

Taken from: [WHO - Safe management of wastes from health-care activities](#)

Medical waste can pose specific threats to humans, animals and the environment, and must be handled appropriately. Infectious waste and pathological waste products in particular are highly sensitive and should only be handled by experts that understand the process, while all of the aforementioned medical waste items are likely subject to some form of regulation or control.

International conventions such as the [Basel Convention on the Control of Transboundary Movements of Hazardous Wastes](#) or the [Stockholm Convention on Persistent Organic Pollutants \(POPs\)](#) in particular define the waste management policies for signatories, however national or local laws may will also outline the procedures. The important thing for logistics personnel to know that that any form of medical waste disposal must be done in a safe and

lawful manner. Under no circumstances should medical waste be disposed of with general waste.

Traditionally, the aggregation and storage of medical waste is not the role of logistics personnel and is usually left to healthcare professionals operating in medical facilities. Due to limitations on personnel and resources, logistics staff in humanitarian fields settings may be required to facilitate the handling, storage or transport of medical waste.

## **Segregation of Medical Waste**

Though local conditions may vary, as a best practice healthcare facility should segregate waste into four categories, each of which should be stored, collected and disposed of separately. The four categories are:





1. Sharps waste (needles and scalpels, etc.), which may or may not be infectious.
2. Non-sharps infectious waste (anatomical waste, pathological waste, dressings, used syringes, and used single-use gloves, etc.).
3. Non-sharps non-infectious waste (paper and packaging, etc.).
4. Hazardous waste (expired drugs, laboratory reagents, radioactive waste and insecticides, etc.).

Almost 85% of medical waste in health centers or hospitals belong to the category of non-sharps non-infectious waste. Any waste item that is cross-contaminated with infectious waste should be considered infectious waste as well, and proper segregation of non-sharps non-infectious waste from infectious waste can significantly reduce the total amount of infectious waste in a health facility. However, in many humanitarian contexts hazardous and non-hazardous healthcare waste is often not separated. If proper segregation cannot be ensured at source, consider all mixed healthcare waste as hazardous.

## **Medical Waste Collection**

Collection and storage of medical waste must be done using suitable storage containers. If no suitable containers are available, humanitarian organisations are strongly advised to procure the appropriate storage containers. As hazardous waste is collected, each container should be properly labelled, and collected waste should be placed in a pre-defined, secure location.

WHO has recommended coding and storage for some medical waste storage, including symbols, colour coding and marking. Recommendations for some common medical waste items are:

Type of Waste	Colour Coding	Symbol	Type of Container
Household refuse (non-sharps non-infectious waste)	Black	None	Plastic bag
Sharps	Yellow and marked with a biohazard symbol:		Sharps container
Waste entailing a risk of contamination and anatomical waste	Yellow and marked with a biohazard symbol:		Plastic bag or container
Infectious waste	Yellow marked "highly infectious" and marked with a biohazard symbol:		Plastic bag or container which can be autoclaved
Chemical and pharmaceutical waste	Brown, marked with a suitable symbol (example)		Plastic bag, container

Adapted from: [ICRC - Medical Waste Management Guidelines](#)

Common storage container examples and practices include:

- Sharps should be placed immediately after use in yellow puncture-proof, covered safe sharps containers, which are regularly collected for disposal. Containers must not be filled above the line indicated on the label, and they must be sealed using the integrated safety lock prior to disposal.
- Non-sharps infectious waste should be placed in yellow or red infectious waste bags or containers (15–40-litre capacity with lids). Bags should be collected and replaced after each intervention or twice daily. Containers should be emptied, cleaned and disinfected after each intervention or twice daily.
- Non-sharps non-infectious waste should be placed in black waste containers (20–60 litre capacity). The containers should be collected, emptied, cleaned and replaced daily; alternatively, plastic bags may be used as liners inside the containers.

Adapted from: [WFP Logistics Cluster - Downstream Logistics in Pandemics](#)

For each of these three waste categories, it is recommended that waste containers are kept no more than five metres from the point of waste generation. Two sets of containers should be provided for each location, for a minimum of three types of waste, or as is required by the

activities in the health facility. In hospital wards, at least one set of waste containers should be provided per 20 beds.

**Example Sharps Container**

**Example Biohazard Bag**



### **Personal Protective Equipment:**

Any persons tasked with collecting and handling medical waste should have the proper and necessary personal protective equipment (PPE). This may include protective eyewear, rubber gloves, aprons, respirators, and the proper body covering. Prior to handling any and all medical waste, personnel should consult with the attending medical staff about the appropriate handling protective equipment. Remember: some health related waste can be extremely hazardous or even lethal if handled incorrectly. If ever logistics personnel are in doubt about the safety of handling medical waste, they should cease activities and consult with a trained professional.

### **Medical Waste Storage**

The storage of medical waste can and will be regulated by prevailing local and national laws. Humanitarian organisations may also have internal guidelines or regulations on storage of medical waste. As an overall rule, humanitarian responders must check on local regulations before designing storage options. Medical waste should also be handled by experienced professionals when and wherever possible. Below are general best practices that *may* be adopted if needed:

#### **General non-hazardous waste storage**

General non-hazardous waste should be stored and kept for collection to recycle (where possible), dispose at a communal landfill/dumpsite, or as a last resort destroyed at communal waste incinerator. It should be collected at least every week. The storage area should be enclosed, paved and connected to a public road. The gate should be big enough that the collection vehicles can enter. If available in the location, non-hazardous cardboards, metals, plastics, paper can be sorted and recycled by local contractors and avoid the need for disposing of in landfills or incineration.

---

<b>Infectious and sharp waste storage</b>	<p>The storage place must be identifiable as an infectious waste area by using the biohazard symbol. Floors and walls should be sealed or tiled to allow easy cleaning and disinfection. Storage times for infectious waste (e.g. the time gap between generation and treatment) should not exceed the following periods:</p> <ul style="list-style-type: none"> <li>• Temperate climate: 72 hours in winter/48 hours in summer.</li> <li>• Warm climate: 48 hours during the cool season/24 hours during the hot season.</li> </ul> <p>If a refrigerated storage room is available, infectious waste can be stored for more than a week cooled to a temperature no higher than 3°C to 8°C.</p>
<b>Pathological waste storage</b>	<p>Pathological waste is considered biologically active and gas formation during the storage should be expected. To Minimise the possibility of this happening, storage places should have the same conditions as for infectious and sharps wastes. Where possible, waste should be stored under refrigerated conditions. In some cultures, body parts are passed to the family for ritual procedures or are buried in designated places. Bodies should be placed in sealed bags prior to release to the family to reduce the risk of infection.</p>
<b>Pharmaceutical waste storage</b>	<p>Pharmaceutical waste should be segregated from other wastes. International and local regulations should be followed for storage. In general, pharmaceutical wastes can be hazardous or non-hazardous, liquid or solid in nature and each type should be handled differently. The classification should be carried out by a pharmacist or other expert on pharmaceuticals.</p>
<b>Storage of other hazardous waste</b>	<p>When planning storage places for hazardous chemical waste, the characteristics of the specific chemicals to be stored and disposed of must be considered (i.e. inflammable, corrosive, explosive). The storage area should be enclosed and separated from other waste storage areas. Storage facilities should be labelled according to the hazard level of the stored waste.</p>
<b>Radioactive Waste Storage</b>	<p>Radioactive waste should be stored in compliance with national regulations and in consultation with the radiation officer. It should be placed in containers that prevent dispersion of radiation and stored behind lead shielding. Waste that is to be stored during radioactive decay should be labelled with the type of radionuclide, date, period of time before full decay and details of required storage conditions.</p>

---

Taken from: [WHO - Safe management of wastes from health-care activities](#)

## Treatment and Disposal

The process for safe and adequate disposal of pharmaceuticals and health related items in

contexts where humanitarians may operate has evolved significantly over the past several decades. Many state and local authorities now have strict regulations on the process of disposing of health waste and may include requirements far beyond the capacities of most individual humanitarian organisations.

As a primary rule, aid agencies should seek to outsource the destruction of medical waste to licensed and recognised third parties, including private companies, or through state managed entities such as local Ministries of Health. Aid agencies should also seek to understand and respect all local laws wherever applicable. Proper disposal usually has a cost associated with it, and organisations should budget for potential disposal costs.

In any situation where waste is disposed of using a third party, or by the organisation following national protocols or WHO guidelines (subject to regulatory framework), proper documentation must be retained and backed up to prove disposal was undertaken in a lawful manner. When and wherever possible, the preferred methods of disposal will always remain going through local authorities, using a certified waste disposal company, or returning products to manufacturers.

In humanitarian contexts however, such options may not always be available. To remedy this, there are a few recommended solutions, including the WHO [Guidelines on Safe Management of Pharmaceutical Waste from Healthcare Facilities](#) and the [safe management of wastes from health-care activities](#). Where disposal is done informally in large scale emergencies, the process must be documented to avoid the suspicion of diversion or health related items, or to avoid the suspicion that expired, damaged, or recalled items were handed out to beneficiaries, or sold illegally. In the event that agencies must dispose of their own medical waste, they are encouraged to speak with local Ministries of Health or other relevant body and consult with representatives from the local health cluster if available.

The [Logistics Capacity Assessments](#) website can provide humanitarian organizations with contact details for licensed waste management companies, overviews on local regulations and procedures in country including medical waste, and lists the existing waste management and recycling facilities in country.

In some local contexts, local factories or industrial plants may use medical waste as a cheap fuel source to keep kilns or smelters running. In any place where medical waste is incinerated by a nontraditional third party, all employees must receive the appropriate training.

## **Medical Waste Disposal Options**

### **High Temperature Incineration**

Medical grade high-heat thermal incinerators are typically comprised of two chambers:

- One chamber of 850 °C
- One chamber of 1,100 °C

Other things to consider when using high temperature incineration:

- A flue gas treatment system may be used to capture hazardous gasses.
- Well-made high temperature incinerators may have remote monitoring to measure carbon monoxide output and temperature.
- Ideally incinerators should conform to emission control standard where available.
- Left over ash and residue should be treated as hazardous waste and must be disposed as such.

- When burning pharmaceuticals, ensure that no more than 5% of all the materials fed to an incinerator at any given time are pharmaceuticals, and avoid any PVC or plastic packaging where possible.

In some local contexts, local factories or industrial plants may use medical waste as a cheap fuel source to keep kilns or smelters running. In any place where medical waste is incinerated by a nontraditional third party, all employees must receive the appropriate training.

### **Small Scale Incineration**

If no other option is available, small-scale incineration (single-chamber, drum and brick incinerators) or burning in a protected pit can be used, but should be considered as a last resort only. Small scale incinerators and burn pits should only be used for small quantities of medical waste.

Burning medical waste in small scale incinerators or pits will release toxic pollutants. General rules include:

- Halogenated waste, including PVC blister packs and plastic packaging should be sorted removed prior to incineration.
- The ash from burning hazardous waste is considered as hazardous and must be disposed in an ash pit.
- A burning pit should be located at an isolated area, away from housing, fenced and covered with a layer of soil after usage (at least 30 cm).
- The burned waste should be recorded, and the location noted.

*Adapted from: Safe Management of Pharmaceutical Waste from Healthcare Facilities*

### **Immobilization**

Immobilization is the process of converting waste into a stable, suitable medium by encapsulation or inertization. It reduces the potential for migration or dispersion of hazardous materials during transport and disposal stages of the waste. The immobilized pharmaceutical material can be disposed of on an engineered sanitary landfill for non-hazardous waste, as the hazardous components of the waste cannot leak into the environment.

#### ***Immobilization: Encapsulation***

Encapsulation is a low-cost method of immobilizing pharmaceuticals in a solid, stable medium, after which it can be buried in a landfill. The process undertaken to encapsulate pharmaceutical waste is:

- Fill a vessel like a metal drum with pharmaceutical waste and inert fillers such as plastic foam, sand, lime, cement mortar, or clay is used to prevent human contact and the environmental risk associated with the pharmaceutical residues.
- Vessels / drums sizes of 30 - 200-litres are the most often used. For large amounts of pharmaceutical fully automated stationary and mobile encapsulation devices with different capacities (~5-16 m<sup>3</sup>) are available.
- Waste and inert fillers mixed manually with a shovel, or with a manual or automatic concrete mixer.
- The vessels should be cleaned before use and should not have previously contained explosive or hazardous materials.
- Vessels should only be filled to 75% capacity with solid and semisolid pharmaceuticals; the remaining space is filled by pouring in a medium such as cement or cement/lime mixture,



plastic foam or bituminous sand.

- Staff should wear proper PPE based on the kind of hazard, including gloves, mask, goggles, closed shoes and an overall or apron.
- The lids should then be sealed, ideally by seam or spot welding. The size of the vessel depends on how possible it is to handle once filled, as they can be heavy.

### ***Immobilization: Inertization***

Inertization is a variant of encapsulation and involves crushing pharmaceuticals and mixing them into a concrete or other paste and pouring the mixture into a safe place. The process requires the removing packaging materials, paper, cardboard, and plastic from pharmaceuticals, including blister packs, and crushing the pharmaceutical waste items using manual or automated means. This process significantly reduces the volumes of waste to be immobilized, but will be more time consuming.

The paste is either filled into drums or transported in liquid form to an engineered sanitary landfill, where it is decanted into the regular municipal waste stream. It is then placed at the base of the landfill and covered with fresh municipal solid waste. The process is relatively inexpensive and can be carried out with unsophisticated equipment. The main requirements are a grinder or road roller to crush the pharmaceuticals, a concrete mixer, and supplies of cement, lime and water.

- Highly toxic waste like antineoplastics or explosive materials like aerosol containers should not undergo Inertization due to the high risk of exposure to humans and the environment.
- Solid pharmaceuticals are ground, and a mix of water, cement and lime added to form a homogenous paste.
- The mixing of materials can be done manually or by concrete mixer. Workers need to be protected with protective clothing and masks are required as there may be a dust hazard.

The approximate ratio by weight used are as follows:

<b>Materials</b>	<b>Percentage (weight)</b>
Pharmaceutical Waste	65%
Lime	15%
Cement	15%
Water	5% or more to form a proper liquid consistency.

Taken from: *WHO - Safe Management of Pharmaceutical Waste from Healthcare Facilities*

### **Dumping and Landfills**

When dumping products, there are two categories of waste disposal sites:

**Engineered sanitary landfills** - An engineered sanitary landfill is a waste disposal site that has been adequately engineered for the purpose of containing waste in a safe way. Engineered sanitary landfills prevent waste from contaminating the environment, and in particular prevent waste from seeping into the below ground water table. Engineered hazardous waste landfills are rarely available in middle and low-income countries, but where available should be explored as a primary method for disposing of pharmaceuticals.

**Uncontrolled dumpsite** - An uncontrolled dumpsite is any solid waste disposal location that is not purpose-built or engineered to isolate or accommodate waste management. Uncontrolled dumpsites are probably the most commonly found dumpsites in locations where humanitarians operate.

As a general set of rules:

---

<b>Where engineered landfills are not available...</b>	Pharmaceuticals should be fully immobilized prior to dumping in an uncontrolled dumpsite.
--	---

---

<b>Where immobilization isn't a possibility...</b>	Pharmaceuticals can be safely buried in an engineered landfill, as long as adequate security is in place.
--	---

---

<b>Where engineered landfills are not available AND immobilization isn't a possibility...</b>	Pharmaceuticals should not be dumped in an uncontrolled dump site. Humanitarian actors should pursue other disposal options. Disposing non-immobilized pharmaceutical waste on uncontrolled landfills or dumpsites poses the risk of environmental contamination as well as the exposes risks to humans as products may be picked up, resold or consumed by other people.
---	---

---

In the event that non-immunized wasted is dumped in an uncontrolled dumpsite:

- Waste should be unpacked to make it unrecognizable.
- The disposal area should be at least 30 meters away from water sources and other water bodies as well as human settlements.
- If hazardous waste is buried, the burial location waste should be documented. Hazardous waste may need to be moved as soon as possible to a safer place at a later state by authorities.

### **Dilution of Liquid Pharmaceuticals**

Dilution and dumping of liquid pharmaceuticals should be avoided wherever possible, however there are some conditions in which dumping non-hazardous liquid pharmaceuticals down a sewer or drain are possible. Non-hazardous pharmaceuticals should be well diluted in water prior to any dumping in a drain or swage system.

---

<b>Example non-hazardous liquid pharmaceuticals</b>	Syrups used for human consumption and IV fluids.
---	--

---

<b>Example hazardous liquid pharmaceuticals</b>	Anticancer medication, hormones/steroids, and controlled drugs.
---	---

---

## Treatment and Disposal of Hazardous Biomedical Waste

Biomedical waste can be defined as:

- **Pathological** - Any waste which consists wholly or partly of human or animal tissue, blood, other body fluids, excretion, drugs or other pharmaceutical products, swabs or dressings, or syringes, needles or other sharp instruments, being waste which unless rendered safe may prove hazardous to any person coming into contact with it
- **Infectious** - Any other waste arising from medical, nursing, dental, veterinary, pharmaceutical or similar practice, investigation treatment, care, teaching or research, or the collection of blood for transfusion, being waste which may cause infection to any person coming into contact with it.

Adapted from: [\*The Controlled Waste Regulations 1992 of United Kingdom\*](#)

Pathological and infectious biomedical waste derived from any activity in a humanitarian setting should always be treated as hazardous waste, and should be treated accordingly. Anytime biomedical waste is handled by personnel, proper protective equipment should be used, including gloves, face covering, and potentially proper aprons and body suits depending on the nature of the biomedical waste.

There are several treatments available for managing biomedical waste:

### **Local Companies/Authorities:**

Wherever possible, humanitarian organizations should consult with local authorities to understand locally available processes and procedures to outsource the process of disposing of biomedical waste.

- There may be local and certified companies capable of collecting and disposing of biomedical waste in compliance with local laws.
- National health authorities may be able to collect or accept deliveries of biomedical waste, or have some sort of appointed collection agency.
- Local hospitals or clinics may be able to intake and dispose of biomedical waste.

### **Autoclaving:**

Some biomedical waste can be decontaminated using autoclaves. Autoclaves are specialized equipment that uses high temperature and pressure to kill biological materials. The use of autoclaves requires special training or supervision of a trained professional. Many humanitarian organizations don't always have access to an autoclave, nor do they have proper training available to them, and should only consider autoclaving as an option where available. Properly autoclaved items can be considered as no longer hazardous and disposed of using the methods described for non-hazardous medical waste, however special considerations must be made:

- Autoclaving should only be undertaken for durable materials, such as used surgical equipment or sharps. Autoclaving cannot be used on bandages or cloth.
- Autoclaves are mostly useful for relatively small quantities of items due to the complexity and energy requirements.
- Prior to using an autoclave to decontaminate biomedical waste, consult with manufacturers of products and local health authorities.

Biomedical waste shall not be considered properly treated unless the time, temperature and pressure requirements have been met. If for any reasons, time temperature or pressure

requirements are not reached, the entire load of medical waste must be autoclaved again until the proper temperature, pressure and time requirements are achieved.

General autoclave guidelines:

**Gravity Flow  
Autoclave**

- No less than 121 C° and pressure of 15 pounds per square inch (psi) for a time of no less than 60 minutes.
- No less than 135 C° and a pressure of 31 psi for a time of no less than 45 minutes.
- No less than 149 C° and a pressure of 52 psi for a time of no less than 30 minutes.

---

**Vacuum Autoclave**

- All medical waste shall be subjected to a minimum of one pre-vacuum pulse to purge the autoclave of all air.
- No less than 121 C° and pressure of 15 psi for a time of no less than 45 minutes.
- No less than 135 C° and a pressure of 31 psi for a time of no less than 30 minutes.

---

Adapted from: [Solid Waste Management - Principles and Practice](#)

**Incineration:**

Incineration of biomedical waste should only be done using high temperature, two chamber incinerators.

- A flue gas treatment system should be used to avoid toxic biohazardous fumes.
- The duration of the incineration depends on the bio-waste, but there should be no remains of volatile organic compounds left in ash.
- All ash bioproduct of incinerated biomedical waste should be treated as hazardous, and will require immobilization or deep burial.

**Deep Burial:**

Deep burial should be considered a last resort for untreated biomedical waste in humanitarian settings. Biomedical waste cannot be disposed of through regular landfills, and instead requires deep burial.

The steps for deep burial include:

- A pit or trench should be dug a minimum of 2 meters deep. The pit should be half filled with biomedical waste, and then covered with lime within 50 centimeters of the surface, after which rest of the pit with soil.
- If the pit is filled incrementally over time, each time waste is added to the pit, a layer of 10 centimeters of soil be added to cover the successive layer.
- Ensured that animals do not have access to burial sites.
- Cover the burial site with galvanised iron/wire meshes - ideally the mesh can be laid on the lime under the soil.
- Burial must be performed under close and dedicated supervision.
- Burials site should not affect water tables, and should not be at least 30 meters from wells or water sources frequented by humans.
- Burial pits should be far from human habitation.
- The area should not be prone to flooding or erosion.

- The location of the site should be negotiated and authorized by local or regional authorities. Permission may be required from national health authorities as well.
- Records should be made and kept of any burial site for future reference.

Adapted from: [Solid Waste Management - Principles and Practice](#)

## Treatment and Disposal Methods of Pharmaceuticals by Category

Treatment and disposal of pharmaceuticals and medical waste can generally be broken down into three categories:

- **Non-hazardous Pharmaceutical Waste** - not classified as hazardous but must still to be disposed of properly to prevent misuse or environmental damage.
- **Hazardous Pharmaceutical Waste** – wasted that poses a risk to health and the environment, due to harmful ingredients and interactions or hazardous characteristic, such as being poisonous, ecotoxic, toxic, carcinogen, flammable, corrosive, reactive, explosive.
- **Hazardous Controlled Substances** - needs to be specifically managed to prevent the diversion and non-medical use of those substances as well as the illicit use of drugs.

A summary table of the guidelines is below:

Category	Physical form	Treatment / disposal methods	Comments
Non-hazardous	Solids / liquids	Engineered sanitary landfill.	
		Municipal Incinerator (850 °C medium temperature).	
		Immobilization followed by disposal on uncontrolled landfill.	Prevention of scavenging
		Burial on non-engineered landfill.	Prevention of scavenging.
	Liquids	Sewerage system.	Only diluted small quantities over time, if no sewer or sewage treatment plant available.
	Aerosols / inhalers	Certified incinerators / emptying of cans and incineration / disposal as solid non-hazardous waste on a municipal landfill.	Prevents exploding / ignition of cans / prevent scavenging.
		Engineered sanitary landfill / immobilization followed by disposal on landfill.	Prevention of scavenging.

<b>Category</b>	<b>Ampoules / vials Physical form</b>	<b>Treatment / disposal methods</b>	<b>Comments</b>
		Emptying and crushing followed by burial in a pit or on a landfill.	Liquids can be disposed with sewage, glass to be packed in drum or container before disposal.
<b>Hazardous Antineoplastics</b>	Solids / liquids	High temperature incinerator (>1,200°C) with flue gas treatment.	Preferred option. Safe disposal of ash.
		Encapsulation followed by disposal on landfill.	Preferred option. Prevention of scavenging. Designated area.
		Chemical decomposition and disposal with sewage.	Treatment by trained and knowledgeable experts.
<b>Hazardous anti-infective drugs</b>	Solids / liquids	High temperature incinerator (>1,100°C) with flue gas treatment.	Preferred option.
		Immobilization followed by disposal on landfill.	Preferred option. Prevention of scavenging. Designated area.
	Liquids	Diluted in water, left for two weeks and disposed to the sewer.	Emergency situations.
	Aerosols / inhaler	High temperature incinerator (>1,100°C) with flue gas treatment.	Preferred option. Constructed / licensed for the treatment of gaseous waste.
		High temperature incinerator (>1,100°C) with flue gas treatment or co-incineration.	Preferred options. Safe disposal of ash.
		Immobilization followed by disposal on landfill.	Preferred option. Prevention of scavenging. Designated area.

<b>Other hazardous waste Category</b>	<b>Solids / liquid Physical form</b>	<b>Treatment / disposal methods</b>	<b>Comments</b>
		High temperature incinerator (>1,100°C) without flue gas treatment.	Interim solution. Safe disposal of ash.
		Disposal on an engineered or controlled landfill.	Interim solution. Disposal on designated area.

Taken from: *WHO - Safe Management of Pharmaceutical Waste from Healthcare Facilities*

### **Non-hazardous Pharmaceutical Waste**

Non-hazardous waste is generally defined as having no direct threat to the environment, but may still be harmful to humans if consumed misused. The non-hazardous waste can be treated and disposed like municipal waste, however the illicit scavenging and reuse of products must be prevented. This may be done by making the products unrecognizable by removing products from packages (packaging, blister and leaflets). Please note, non-hazardous waste mixed with hazardous waste should be considered as hazardous.

### **Hazardous Pharmaceutical Waste**

#### **Antineoplastic (Cancer) Drugs**

Antineoplastic drugs are designed to stop or kill growing cells and should be considered highly hazardous.

Antineoplastic waste treatment and disposal options are:

- Antineoplastic products should be returned to vendor wherever possible.
- If products cannot be returned to their vendor, they must be disposed of in a two-chamber incinerator rated for this kind of product, or encapsulation followed by disposal in a landfill – intertization is not permitted.

There are special considerations for antineoplastic during disposal that must be followed:

- Antineoplastics should be segregated from other pharmaceuticals and kept separately in clearly marked containers with solid walls.
- Incinerators must be high temperature and multi chamber. A flue gas treatment system is mandatory to capture toxic fumes.
- Ash from antineoplastic incineration is also considered hazardous waste and must be disposed of through immobilization.
- Anyone handling antineoplastic drugs should avoid crushing containers or removing products from packages.

Encapsulation for antineoplastics should follow its own protocols:

- Drums used to encapsulate antineoplastics should be filled to a maximum of 50% capacity

with waste drugs.

- A well-stirred mixture of lime, cement and water should be poured into the drums in the proportions of 15:15:5 (by weight).
- Filled drums should be sealed by seam or spot welding and left to set for 7 to 28 days.

### **Anti-Infective Products**

Anti-infective products cannot be disposed of in an untreated form. The steps for disposing of anti-infective products include:

- Anti-infective products should be returned to vendor wherever possible.
- If products cannot be returned to their vendor, they must be disposed of in a two-chamber incinerator rated for this kind of product, or immobilization followed by disposal in a landfill.

### **Other Hazardous Medical Waste**

For the disposal of other hazardous medical waste, the general rule is to incinerate the items using a high temperature incinerator, or immobilization. Other options include:

- Storage of waste until safe disposal is possible.
- Medium temperature incineration ( $\geq 850$  °C) may be used for solid form pharmaceutical, however the pharmaceutical items must be intermixed with other non-hazardous waste.
- As a last resort, small quantities of solid and semi-solid pharmaceuticals can be disposed of in uncontrolled landfills, provided the overall volume makes up less than 1% of the total daily waste.

### **Hazardous Controlled Substances**

Controlled pharmaceutical products may not be environmentally harmful, but they should always be considered harmful to humans, and must be treated as hazardous waste. Proper treatment of controlled pharmaceuticals includes high temperature incineration and encapsulation/intertization.

Controlled substances must never be disposed in a way that humans may gain uncontrolled access. Small or medium sized incinerators may be used, but should occur in a well-ventilated area away from humans or animals.

### **Disposal by Dosage Form**

There are suggested disposal methods based on the dosage form/delivery mechanism of some common pharmaceutical items. These methods differ based on if the items contain hazardous or non-hazardous substances or compounds.

### **Ampoules and Vials**



<b>Non-hazardous substances in ampoules and vials</b>	Glass ampoules and vials filled with non-hazardous pharmaceuticals can be disposed of in traditional landfills, or recycled. Non-hazardous substances contained in the vials may be dumped or diluted in accordance with the standard process for disposing on non-hazardous waste. Vials may also be crushed prior to disposal to save space, however crushing must be done in a safe manner – all persons involved in crushing must wear proper clothing, eye protection, mouth covering, and close toed shoes resistant to puncturing.
<b>Hazardous substances in ampoules and vials</b>	Glass ampoules and vials containing hazardous substances should not be opened or crushed. Any ampoules or vials containing hazardous substances must be incinerated in a high temperature incinerator rated for the product, or encapsulated and buried safely. Ampoules and vials should not be burnt or incinerated in medium or small-scale incinerators – vials may explode, while melted glass may build up and damage incinerators for future use.

**Aerosol Cans and Gas Inhalers**

Prior to disposing of inhalators or aerosol cans, always check the product manufacturer’s recommended guidelines first. Metered dose inhalers (MDIs) are pressurized containers and should not be punctured or incinerated, even when they appear to be empty, due to the risk of explosion.

<b>Non-hazardous substances in aerosol cans and gas inhalers</b>	Non emptied aerosol cans and inhalers containing non-hazardous substances can be emptied, and the empty canisters disposed of in traditional landfills or recycled if possible. The process of emptying canisters of non-hazardous substances should be in compliance with the standard process for disposing of non-hazardous compounds.
<b>Hazardous substances in aerosol cans and gas inhalers</b>	Non emptied aerosol cans and inhalers that contain hazardous substances should be destroyed by high temperature incinerators. Incinerators used for compressed containers must be specifically licenced and rated for this purpose.

**Identifying Hazardous Pharmaceuticals**

Please reference the below table for a comprehensive list of potential hazardous pharmaceutical products and their known dosage forms.

<b>Category</b>	<b>Pharmacologic Classes</b>	<b>Dosage form: liquid (L), solid (S), semi-solid (SS), gaseous (G)</b>	<b>Non-hazardous</b>	<b>Hazardous</b>
<b>Analgesics</b>	Non-opioid Analgesics	L, S, SS		x
	Opioid Analgesics	L, S, SS		x
<b>Anesthetics</b>	Local Anesthetics	L, SS		x
	General Anesthetics	L, S, G		x
<b>Antibacterials</b>	Aminoglycosides	L		x
	Beta-lactam, Cephalosporins	L, S, SS		x
	Beta-lactam, Penicillin	L, S, SS		x
	Macrolides	L, S, SS		x
	Quinolones	L, S, SS		x
	Sulfonamides	S, SS, SS		x
	Tetracyclines	S, L, SS		x
Other Antibacterials	S, L, SS		x	
<b>Anticonvulsants</b>	Calcium Channel Modifying Agents	S		x
	Gamma-aminobutyric Acid (GABA) Augmenting Agents	S, L		x
	Glutamate Reducing Agents	S, L		x
	Sodium Channel Inhibitors	S, L		x
	Anticonvulsants, Other	S, L		x
	Cholinesterase Inhibitors	L, S		x
	Glutamate Pathway Modifiers	L.S		x
	Antidementia Agents, Other	L, S		x

<b>Antidementia Agents</b>				
<b>Category</b>	<b>Pharmacologic Classes</b>	<b>Dosage form: liquid (L), solid (S), semi-solid (SS), gaseous (G)</b>	<b>Non-hazardous</b>	<b>Hazardous</b>
<b>Antidepressants</b>	Monoamine Oxidase Inhibitors	S		x
	Serotonin/Norepinephrine Reuptake Inhibitors	S, L		x
	Tricyclics	S		x
	Antidepressants, Other	S, L		x
<b>Antidotes, chelators, Deterrents, and Toxicologic Agents</b>	Antidotes	S, L		x
	Deterrents (Smoking Cessation Agents, Alcohol Deterrents)	S, L		x
	Toxicologic Agents (Opioid Antagonists)	S, L		x
<b>Antiemetics</b>	Antiemetics	S, L		x
<b>Antifungals</b>	Antifungals	S, L, SS		x
<b>Antigout Agents</b>	Antigout Agents	S, L		x
<b>Anti-inflammatory Agents</b>	Glucocorticoids	S, L		x
	Nonsteroidal Anti-Inflammatory Drugs	S, L, SS		x
<b>Antimigraine Agents</b>	Abortive	S, L, SS		x
	Prophylactic	S, L, SS		x
<b>Antimyasthenic Agents</b>	Parasympathomimetics	S, L		x
<b>Antimycobacterials</b>	Antituberculars	S, L		x
	Antimycobacterials, Other	S, L		x
	Alkylating Agents	S, L		x
	Antiangiogenic Agents	L		x
	Antiestrogens/Modifiers	L		x
	Antimetabolites	S, L		x

<b>Category</b>	<b>Pharmacologic Classes</b>	<b>Dosage form: liquid (L), solid (S), semi-solid (SS), gaseous (G)</b>	<b>Non-hazardous</b>	<b>Hazardous</b>
<b>Antineoplastics</b>	Aromatase Inhibitors, 3rd Generation	L		x
	Molecular Target Inhibitors	L,		x
	Monoclonal Antibodies	L,		x
	Retinoids	L,		x
	Antineoplastics, Other	L,		x
<b>Antiparasitics</b>	Anthelmintics	S, L, SS		x
	Antiprotozoals	S, L, SS		x
	Pediculicides/ Scabicides	S, L		x
<b>Antiparkinson Agents</b>	Antiparkinson Agents	S, L, SS		x
<b>Antipsychotics</b>	Atypicals	S, L		x
	Conventional	S		x
<b>Antispasticity Agents</b>	Antispasticity Agents	S, L		x
<b>Antivirals</b>	Anti-cytomegalovirus (CMV) Agents	S, L		x
	Antihepatitis Agents	S, L, G		x
	Antiherpetic Agents	S, L		x
	Anti-human Immunodeficiency Virus (HIV) Agents, Fusion Inhibitors	S,		x
	Anti-HIV Agents, Non-nucleoside Reverse Transcriptase Inhibitors	S		x

<b>Antivirals</b>				
<b>Category</b>	<b>Pharmacologic Classes</b>	<b>Dosage form: liquid (L), solid (S), semi-solid (SS), gaseous (G)</b>	<b>Non-hazardous</b>	<b>Hazardous</b>
	Anti-HIV Agents, Nucleoside and Nucleotide Reverse Transcriptase Inhibitors	S		x
	Anti-HIV Agents, Protease Inhibitors	S		x
<b>Anxiolytics</b>	Antidepressants	S		x
	Benzodiazepines	S		x
	Anxiolytics, Other	S, L		x
<b>Bipolar Agents</b>	Bipolar Agents	S, L		x
	Benzodiazepines	S, L		x
<b>Blood Glucose Regulators</b>	Antidiabetic Agents	S, L		x
	Glycemic Agents	S, L		x
	Insulins	L		x
<b>Blood Products</b>	Anticoagulants	S, L		x
	Blood Formation Products	L		x
	Coagulants	S, L		x
	Platelet Aggregation Inhibitors	S, L		x
	Alpha-adrenergic Agonists	S		x
	Alpha-adrenergic Blocking Agents	S		x
	Antiarrhythmics	S, L		x
	Beta-adrenergic Blocking Agents	S, L		x
	Calcium Channel Blocking Agents	S, L		x
	Diuretics	S, L		x

<b>Cardiovascular Agents</b>				
<b>Category</b>	<b>Pharmacologic Classes</b>	<b>Dosage form: liquid (L), solid (S), semi-solid (SS), gaseous (G)</b>	<b>Non-hazardous</b>	<b>Hazardous</b>
	Dyslipidemics	S, L		x
	Renin-angiotensin-aldosterone System Inhibitors	S, L		x
	Vasodilators	S, L		x
	Cardiovascular Agents, Other	S, L		x
	Amphetamines	L		x
	Non-amphetamines, ADHD	L		x
	Non-amphetamines, Other	L		x
<b>Dental and oral Agents</b>	Dental and oral Agents	S, L, SS		x
<b>Dermatological Agents</b>	Dermatological Agents	L, SS		x
<b>Enzyme Replacements/Modifier</b>	Enzyme Replacements/Modifier	S, L, SS		x
	Antispasmodics, Gastrointestinal	S, L, SS		x
	Histamine2 (H2) Blocking Agents	S, L		x
	Irritable Bowel Syndrome Agents	S, L		x
	Protectants	S, SS		x
	Proton Pump Inhibitors	S, L		x
	Gastrointestinal Agents, Other	S, L, SS		x
	Antispasmodics, Urinary	S, L		x
	Benign Prostatic Hypertrophy Agents	S, L		x

<b>Genitourinary Agents Category</b>	<b>Pharmacologic Classes</b>	<b>Dosage form: liquid (L), solid (S), semi-solid (SS), gaseous (G)</b>	<b>Non-hazardous</b>	<b>Hazardous</b>
	Phosphate Binders	S		x
	Genitourinary Agents, Other	S, L		x
<b>Hormonal Agents, Stimulant/ Replacement/ Modifying (Adrenal)</b>	Glucocorticoids/ Mineralocorticoids	S, L		x
<b>Hormonal Agents, Stimulant/ Replacement/Modifying (Pituitary)</b>	Hormonal Agents, Stimulant/Replacement/Modifying (Pituitary)	L		x
<b>Hormonal Agents, Stimulant/ Replacement/ Modifying (Prostaglandins)</b>	Hormonal Agents, Stimulant/Replacement/ Modifying (Prostaglandins)	S, L		x
<b>Hormonal Agents, Stimulant/ Replacement/ Modifying (Sex Hormones/Modifiers)</b>	Anabolic Steroids	S, L		x
	Androgens	S, L		x
	Estrogens	S		x
	Progestins	L		x
	Selective Estrogen Receptor Modifying Agents	S		x
<b>Hormonal Agents, Stimulant/ Replacement/Modifying (Thyroid)</b>	Hormonal Agents, Stimulant/Replacement/Modifying (Thyroid)	S		x
<b>Hormonal Agents, Suppressant (Adrenal)</b>	Hormonal Agents, Suppressant (Adrenal)	S, L		x
<b>Hormonal Agents, Suppressant (Parathyroid)</b>	Hormonal Agents, Suppressant (Parathyroid)	S, L		x

<b>Category</b>	<b>Pharmacologic Classes</b>	<b>Dosage form: liquid (L), solid (S), semi-solid (SS), gaseous (G)</b>	<b>Non-hazardous</b>	<b>Hazardous</b>
<b>Hormonal Agents, Suppressant (Pituitary)</b>	Hormonal Agents, Suppressant (Pituitary)	S, L, G		x
<b>Hormonal Agents, Suppressant (Sex Hormones/Modifiers)</b>	Antiandrogens	S		x
<b>Hormonal Agents, Suppressant (Thyroid)</b>	Antithyroid Agents	S		x
<b>Immunological Agents</b>	Immune Stimulants	L		x
	Immune Suppressants	S, L		x
	Immunizing Agents, Passive	L		x
	Immunomodulators	S, L		x
<b>Inflammatory Bowel Disease Agents</b>	Glucocorticoids	S, L		x
	Salicylates	S		x
	Sulfonamides	S		x
<b>Metabolic Bone Disease Agents</b>	Metabolic bone disease agents	S, L		x
<b>Ophthalmic Agents</b>	Ophthalmic Anti-allergy Agents	L		x
	Ophthalmic Antiglaucoma Agents	L		x
	Ophthalmic Anti-inflammatories	L		x
	Ophthalmic Prostaglandin and Prostanoid Analogs	L		x
	Ophthalmic Agents, Other	L		x
<b>Otic Agents</b>	Otic agents	L		x



<b>Category</b>	<b>Pharmacologic Classes</b>	<b>Dosage form: liquid (L), solid (S), semi-solid (SS), gaseous (G)</b>	<b>Non-hazardous</b>	<b>Hazardous</b>
<b>Respiratory Tract Agents</b>	Antihistamines	S, L, SS,		x
	Anti-inflammatories, inhaled Corticosteroids	S, L, SS, G		x
	Antileukotrienes	S		x
	Bronchodilators, Anticholinergic	L, G		x
	Bronchodilators, Phosphodiesterase Inhibitors (Xanthines)	S, L		x
	Bronchodilators, Sympathomimetic	L		x
	Mast Cell Stabilizers	SS, G		x
	Pulmonary Antihypertensives			x
	Respiratory Tract Agents, Other	S, L, SS, G		x
<b>Sedatives/Hypnotics</b>	Sedatives/hypnotics	S, L		x
<b>Skeletal Muscle Relaxants</b>	Skeletal muscle relaxants	S, L		x
<b>Therapeutic Nutrients/Minerals/ Electrolytes/ Metals</b>	Electrolytes	S, L	x	
	Minerals	S, L	x	
	Vitamins	S, L	x	
	Metals	L		x

Taken from: *WHO - Safe Management of Pharmaceutical Waste from Healthcare Facilities*

## **Transport of Medical Items**

### **Transporting Temperature-Regulated Medical Items**

The transportation of medical relief items, including medical relief item that require

temperature controls of various kinds, is an increasing component of modern humanitarian response activities. Agencies responding to any given emergency will be confronted with a variety of transportation decisions based upon handling needs and local regulations.

Many of the same GXP/GSP/GDP requirements for storage also apply for transportation. The transport and movement of medical items, particularly drugs, needs to be carried out in such a way as to prevent deterioration of the quality of the items, and in a way to also to prevent the infiltration of counterfeit and substandard items into the supply chain or the theft of valuable items. Key considerations include:

- The specific requirements for temperature-regulated medicines.
- Ideally transport containers of medical items, particularly drugs and medical devices, should not be used for other goods (especially food and fuel). Where not possible, they must be packed separately and clearly marked as medical items and should be protected from other items (e.g. items using a tarpaulin).
- The quality of medical items can be significantly affected during their loading and unloading during transport.
- The fragile nature of many medical items requires dedicated attention and oversight in loading and off-loading, as well as transport method selection.
- Sufficient security measures for controlled substances should be put in place.
- Documents should be maintained with the goods containing expiration dates, countries of origin, or other information as required by local authorities.

It is important to keep in mind that some countries have requirements for certification to transport medicines domestically (GDP certification) as well as strict requirements for the transportation of narcotics.

Depending on the external ambient temperature, stability of the product and length of the journey, temperature-controlled transport solutions may be required for the majority of medical items - including those requiring +15°C to +25°C storage ranges.

## **Evaluating the Journey**

To evaluate the journey, some of the criteria to be consider are:

- The transport modes and vehicle types.
- The journey distances and its expected duration.
- The environmental conditions: temperature (day–night and seasonal temperature extremes) and geographical and natural hazards.

There are 3 basic transportation stages in the supply chain of temperature-controlled medical items:

1. From the manufacturer to a primary or central store: usually international shipments.
2. Between (intermediary) stores: normally between national or district store facilities and down to the health care facility.
3. Outreach transportation: final keep cool item delivery during regular EPI or to a vaccination site during a mass vaccination campaign.

Evaluating the entire journey can reveal gaps, such as lack of temperature-controlled storage at customs, or excessive lead times to delivery cargo items down-stream. It is strongly advisable for humanitarian organisations to consider the entire journey when shipping medical relief items, especially those with time sensitive and temperature-control requirements.

Aerial or terrestrial modes are preferred for transportation of items that are time sensitive, or

carried in passive cold chain containers. Air transport is usually chosen for international or long-distance shipments. In most humanitarian contexts, terrestrial land transport is usually for transport of items carried in passive keep cool container within the same country, unless refrigerated trucks are readily available in the context. Outreach is often done by any land transport mode: car, motorcycle, bicycle. Because of the long duration of the journeys, passive keep cool containers are rarely transported through waterborne means.

## **Enacting Shipments of Temperature-Controlled Medical Items**

### **Shipment Documentation**

Having the proper documentation in time is critical for any shipment of time sensitive temperature-controlled medical items as any delay might expose the items to inappropriate temperature conditions, especially through cross-border supply chains. In the event of international shipments, the shipper must provide the cargo details with sufficient time in advance to allow the consignee to prepare for the reception. In addition to the commonly accepted [standard set of shipping documents](#) and [documents associated with importation](#), shippers should review all required shipping documents prior to shipping with relevant customs broker and health authorities. Ideally, all documents and information should include:

- Date and time for place of departure, transit (if applicable), and arrival.
- Any temperature requirements.
- Type of item, total number of primary containers/vials and number of doses per primary container/vials.

One set of the original documents above must also be placed inside the parcel numbered "1". This particular parcel should be clearly labelled with the words "Containing shipping documentation".

Any time temperature-controlled medical items are to be transported using commercial carriers, humanitarian organisations will still need to specify and declare key information up front. This will include.

- Maximum and minimum temperature ranges.
- (If required) [Supplying safety data sheets](#) (SDS) for live vaccines, chemical coolant packs, or anything else that might qualify as dangerous goods.
- Sufficient security measures for controlled substances.
- Documents containing expiration dates, countries of origin, or other information as required by local authorities.

**For shipping vaccines** – Additional documentation may be required, including:

- Lot Release Certificate issued by the national regulatory authority (NRA) of the country of manufacture for each lot of items in the shipment, together with the Certificate of Pharmaceutical Product (also by the NRA).
- Lot Summary Protocol of production and quality control.

A list of contact points for national regulatory authorities in countries producing vaccines pre-qualified for purchase by United Nations agencies can be found in [WHO Guidelines on the international packaging and shipping of vaccines](#).

### **Air Shipments**

Temperature sensitive shipments must be booked to the air company under the proper handling code and as “temperature-controlled health-care cargo”, as this is an exceptional service beyond that offered for general cargo.

## **Road Shipments**

For road shipments, it is critical to coordinate the delivery with the consignee before dispatch and confirm pick-up time and location.

To reduce as much as possible the temperature-controlled medical items are outside active devices and to exploit cold life of any used passive containers, prepare and pack products in its designated packaging the same shipping day.

If using a third-party logistics provider, make sure that they are prequalified and approved for freight forwarding/transport.

If time sensitive temperature-controlled medical items through a third-party transporter:

- Ensure the transporter knows the exact limits on time for deliver.
- Include clear instruction on handling requirements of keep cool boxes/items.

If a humanitarian organization is organising the shipment by own means, it is best practice ensure that the designated vehicle is in good working condition and that the driver is aware of the cargo sensitiveness. Provide the driver with clear instructions and the necessary means to ensure proper load, handling and transport. This should include:

- Using refrigerated vehicles where possible. If refrigerated vehicles are not available, place temperature sensitive items in shaded areas.
- Fragile boxes/containers should be secured.
- Use of shaded and secure parking areas, minimising the time during which the vehicle is unattended.
- Avoid opening the refrigerated vehicle or keep cool containers during transit.
- Emergency contact information to call in case of breakdown or unexpected events.

The arrival of a temperature-controlled medical items in a country, and their subsequent clearance through customs and transportation to a central store are the most critical stages in the shipping process. These are frequently the times when mistakes and delays occur, resulting in damage or loss of items.

## **Receiving Temperature-Controlled Medical Items**

### **Reception at Customs**

Clearing of any items through custom should follow the normal procedures of that country, however there are few extra things logistics personnel should consider temperature-controlled medical items.

The first step in the customs clearance process, is contacting the following entities to obtain or verify the import procedures:

- National regulatory authorities (NRA) or head of customs in the destination country. To be cleared, the imported items must have received marketing authorisation and a release certificate from the national regulatory authority.
- Local Ministry of Health (MOH): depending on country specific requirements, the MOH may issue a letter approving the shipment.

As reference, the general steps are:

- Submission of shipping documents (as soon as they are received) with a request to customs authority for the provisional clearance of shipment to the nominated Clearing and Forwarding agent.
- The clearing and forwarding agent immediately processes the shipping documents as per established rules and regulations of government and contacts customs and airlines to coordinate the arrival, transport, checking and safe storage of the items.
- Continuous contact is maintained well in advance with the concerned airlines to get accurate and updated information of the flight arrivals of the shipments.
- Once the flight/vehicle arrives, immediate action is taken to release and take delivery of the keep cool shipment and to safely transport the items to the temperature regulated storage locations.
- The clearing and forwarding agent checks the cold-chain monitor(s) and other mechanism (if necessary) to identify and reconfirm that the temperature-sensitive items arrived in good condition before removing the shipment from the airport.
- Irrespective of the condition of the temperature-sensitive items at the time of clearance, the clearing and forwarding agent clears the items and delivers as per regular procedures.
- The clearing and forwarding agent informs the concerned official(s) in a timely manner and arranges for the cold room and the required staff to be ready and available to receive/store the keep cool items.
- There should be a system in place to arrange to open the cold room and liaise/contact with the storekeeper/cold room staff at any time (24-hours/day, including weekends and holidays).
- Under no circumstances can any temperature-sensitive item be left unattended, or outside of the cold room in an open space.
- Unannounced shipments are cleared in time, like all other shipments.
- A reliable transport system including a refrigerated/insulated van should be made available at all times for effective transportation and delivery of the keep cool items.

In special instances where regular customs procedures may not be in place – such as extraordinary emergency conditions or use of military aircraft - humanitarian organisations may have to be prepared to receive keep cool shipments under their own volition. This includes having the adequate vehicles waiting at the point of reception and providing the receiving party with all anticipated times of arrival and handling instructions.

Importing temperature-controlled medical items through ports that don't have the adequate cold storage facility is not recommended. In the event of receiving a shipment of needing clearance in a port without cold storage facility or if the cold room is inaccessible, arrangements should be done for immediate release of the shipment. Coordination with the relevant authorities for an agile clearance and/or for safe and appropriate management and storage of temperature-controlled medical items at the airport are therefore needed.

### **Reception at the Storage Facility**

Any reception facility receiving medical items that have temperature control requirements, other other specialty handling needs should have the capacity to receive and adequately store medical items in the proper way. Prior to shipping any medical items, humanitarian organisations should evaluate if storage facilities can safely receive and store those medical items.

Ensure priority unloading of all shipments of temperature-controlled medical items. If multiple

vehicles arrive at the same time, prioritize unloading the most time sensitive items, or the items that have the shortest capacity for transport (items contained in passive cold chain containers)

Move the product immediately to the appropriate place in the storage facility. Open packaging, retrieve and inspect the temperature monitors, remove product from its passive shipping container and move it immediately to the correct temperature-controlled storage conditions.

If the temperature monitor shows a change that indicates potential deviation, take a picture, photocopy or scan that show alarm status. This information should be used to make decisions on whether to accept the product, or whether to quarantine it until an investigation has taken place and a final disposition has been made.

If using dataloggers or tags that record time and temperature data that can be downloaded, retrieve and store time and temperature data. The point in time when a temperature excursion has occurred is important for the purchasing agency and/or the manufacturer so they can identify the cause of the excursion, take corrective measures, avoid similar situations in future shipments, and for insurance purposes.

Clearly identify temperature-controlled medical times in boxes in which the indicator shows exposure to temperatures that risk damage and keep them at the required temperature for further assessment of their condition. Do not discard potentially damaged items until a full assessment is completed.

Verify that all necessary documents are present. *In the case of vaccines*, do not use the vaccines if the lot release certificate is missing. In that case, keep vaccines on hold in cold storage until the relevant document has been obtained from the vaccine manufacturer.

Report any relevant information to the carrier and to the appropriate personnel in your organisation. In case of loss or damage, review insurance policy clauses and follow the insurance claim instructions.

## **Labelling Containers of Medical Items**

Containers carrying temperature regulated medical items should be properly labelled with the handling and temperature requirements on the side. Specific requirements exist for the labelling of international/air shipments. Therefore, a distinction must be made between international/air and domestic shipping.

### **International/Air Shipments**

For international/air shipments, a label must be affixed to the front surface of each package indicating type of item, name of manufacturer, presentation, batch number, date of manufacture, date of expiry, quantity, and storage conditions. The manufacture date and expiry date on all labels should be written in full, not in a coded form (i.e. June 2017, not 06.17). In addition, required temperature conditions for transportation must be clearly visible on the outer carton, indicating clearly where recommended transportation temperatures differ from recommended storage temperatures.



A "Vaccine Rush" Label must be affixed to each face of the vaccine package



A "Do Not Freeze" label must be affixed to those packages (in each face) containing freeze-sensitive vaccines, droppers or diluents.



An IATA Time and Temperature Sensitive Label (mandatory from 2012). The lower half of the label must never be left blank and must indicate the external transportation temperature range of the shipment - this can be handwritten or printed onto the label.

---

Labels must be written in a language appropriate to the country of destination.

### Domestic/Road Shipments

There is no specific international regulation for labelling medical shipments transported by road. Nevertheless, becoming knowledgeable in the laws of all of the countries in your distribution channel can help to avoid administrative burden and delivery delays.

In any case it is recommended that shipper and consignee agree on a basic standard operational procedure to pack, label and receive temperature-controlled medical shipments. Among other topics, the procedure should establish the warning signs about time and temperature sensitiveness of the parcels, and shipping labels should indicate temperature requirements on the outside.

## Temperature Monitoring Devices for Transportation

Much like monitoring temperatures in a warehouse, there are a variety of temperature monitoring techniques and devices available for monitoring temperature of health related items while in transit. These devices can come in the form of:

- **Electric** – Devices that require power and can usually interface with a computer.
- **Chemical** – Monitors that rely on chemical reactions to produce indications of temperature conditions.
- **Passive** – Temperature indicators cannot or do not communicate with external servers or alarms.
- **Active** – A device that has the capacity to send continuous data to a central data point and can be used to see temperatures in real time.

The requirements for duration of shipments, required temperature ranges, reusability needs, access to basic infrastructure, real world conditions on the ground, and other key needs will dictate the types of monitoring devices used. In modern humanitarian contexts, the last mile delivery of humanitarian supplies usually operates without adequate temperature-controlled transport or monitoring. In the event that adequate temperature monitoring for all items isn't available, prioritisation of data loggers for the most sensitive and high risk products should be ensured. Continual monitoring of pharmaceutical and health items that should be kept at the +15°C - +25°C range may not be required in all situations, and humanitarian agencies may only wish to enact monitoring upstream or in more stable conditions. At the same time, local or national laws may actually require all temperature-controlled shipments to be monitored at all times, with documented evidence.

Agencies operating in humanitarian contexts should build a monitoring plan that makes sense based on the requirements on the ground. In the event that there are bottlenecks in end-to-end temperature monitoring, mitigation measures can be implemented, such as random inclusion of a single datalogger for an entire consignment, with collection and analysis by the organisation after supplies arrive to the point of use.

Additionally, active temperature monitoring devices tend to be too complex, too expensive, or otherwise require training and infrastructure that isn't available in most humanitarian contexts. Commercial service providers will frequently employ active monitoring in large international shipments, or for entire vehicle loads such as reefer trucks or reefer containers, but individual humanitarian organisations will likely require a variety of monitoring techniques when and where required. Some of the more common passive temperature monitoring devices might include:

**Temperature Dataloggers** – Temperature dataloggers have become the most commonly used temperature monitoring devices for most medium to small shipments. Temperature dataloggers are small, electronic and usually passive monitoring devices that can continually monitor temperature for up to weeks at a time, depending on the device. The advantage of a temperature datalogger is that it displays a chronological “history” of the temperature conditions as long as the device was turned on, and shippers can witness fluctuations in temperatures or even see multiple temperature excursions time-stamped against real world events. This will help shippers identify problems and work with transport companies and employees to fix problems.

There are a variety of datalogger devices available on the market, including dataloggers that can plug directly into USB ports and download data, dataloggers that have electronic displays on the side, dataloggers that have programmable temperature ranges, and dataloggers that can be recharged and reused. The overall type and requirement for the datalogger brand depends on the needs of the shipper.



Once activated, temperature dataloggers can be dropped into a box or package of health items and retrieved on the other end. Temperature dataloggers can therefore be used when shipping single boxes, or when shipping pallets or large volumes of items, and can be used when shipping across multiple carriers or multiple modes of transportation.

When using temperature dataloggers, humanitarian organisations should:

- Understand what their overall requirements are – what temperature ranges are required, how long will monitoring be required, will the reuse of the device be required?
- Consult the manufacturer guidelines and instruction manuals.



- Ensure that both senders and receivers understand how to use the devices and understand their importance.
- Have a plan for recovering and backing up data from temperature dataloggers at points of reception and have a plan for reviewing data and taking corrective steps in case of any identified problems.

New advancements in technology are always underway, and newer versions dataloggers are continually being developed. Logistics personnel should conduct a market survey of the latest technology when selecting a product.

**Chemical Indicators** - Also called markers or phase-change indicators). They are the most accessible and easy to use, they are based in a chemical impregnated onto a paperboard that changes its appearance under certain temperature. There are two types of chemical indicators:

1. Threshold type.
2. Progressive type.

*Threshold Type* chemical indicators provide a signal only when exposed to temperatures higher than (ascending indicator) or lower than (descending indicator) a predetermined threshold temperature. They are irreversible (thus, single use) and are suitable for high or low temperatures.

Example of these devices are:



*Progressive Type* chemical indicators register multiple events in a cumulative way. Whenever the threshold temperature is exceeded, the reaction is activated, and the indicator starts to change. Further temperature violations increase the change process. The indicator for this type of device usually takes the form of a progressive colour change along a paper strip.

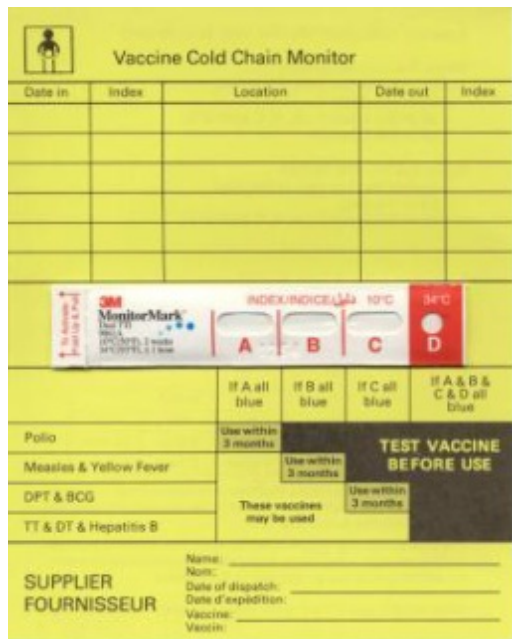

### Cold Chain Monitor (CCM) Card

Paper-based temperature monitoring device which change colour irreversibly and at a constant rate. Indicator strips are attached to a card on which instructions for use are printed.

CCMs provide a warning when excessive heat exposure occurs during transport. They are used primarily to monitor the international shipment of freeze-dried vaccine consignments where dry ice is used. CCMs may also be appropriate for national vaccine shipments where the delivery takes several days.



### Vaccine Vial Monitor (VVM):

Heat-sensitive label that gradually and irreversibly changes colour as the vaccine is exposed to heat. It warns the health worker when a vial should be discarded because the vaccine is likely to have been degraded by exposure to heat. For instructions on how to interpret VVM, refer to WHO [How to Monitor Temperatures in the Vaccine Supply Chain](#)

**Electronic Freeze Indicators** - used to check if shipments are exposed to freezing temperatures during storage or transport. The alarm indicator is triggered and displayed (changing from a "□" to an "X") if exposed to temperatures lower than  $-0.5^{\circ}\text{C}$  for a continuous period of 60 minutes. To avoid malicious manipulation, once the alert is triggered, the alert is irreversible. If this happens the device is no longer usable and should be discarded. Otherwise, the device can be used until the built-in battery expires. The intermittent "dot" icon confirms active monitoring.



**Electronic Shipping Indicators** - more sophisticated devices that show if a product has been exposed to temperatures beyond the assigned alarm settings. They record the temperature at regular intervals during a certain period (normally not exceeding 20 days due to memory overflow). They have a digital display that reflects if the item being shipped crossed the alarm thresholds.

Shipping indicators are mounted on a coloured card (yellow or blue) with a data entry section on one side, which the manufacturer fills in at the point of dispatch, and an instruction and interpretation section on the reverse side for the recipient. Yellow indicators are for freeze-sensitive items, and blue indicators are for heat-sensitive items.

These devices are not re-usable once alarm conditions are triggered or the programmed time elapses. In addition, the heat and/or freeze alarm thresholds are product-specific, which means that the device is not reusable with different products than originally intended. Some brands are able to download the temperature data to a computer. This enables recipients to determine whether shipments have been exposed to excessively high or low temperatures; it also helps the procurement agency to determine when, where and to what extent temperature limits have been exceeded.



## Active Cold Chain Transportation

Active cold chain transport methods broadly refer to any method of transportation that provides supplemental power, mechanical or chemical processes to maintain temperatures while cold chain items are in transit. Active cold chain can come in a variety of forms – the transport method itself could be completely refrigerated, or supply power to self-contained containers that have a cooling effect on the required cargo. Active cold chain equipment can come in many sizes and form factors but is generally better suited for large volumes of temperature regulated health items, or when local regulations require it. Active cold chain transport items can typically be calibrated to a specific set point, which is adjustable based on

the transport needs.

## Refrigerated Road Vehicles

Refrigerated road vehicles come in a variety of formats, but generally are characterised by:

- Rigid, enclosed structures.
- Active cooling from permanently mounted air conditioner or freezers that draw power either directly from the engine of the vehicle, or specialised independent motors.
- Insulated interior walls/ceiling/floor.
- A tightly closing, sealable door or doors with proper insulated lining.
- An electronically controlled thermostat with an adjustable set point.
- Some refrigerated vehicles have built in alarm systems in case of a temperature excursion.

Refrigerated vehicles can come in the form of:

- Vans.
- Single unit box trucks.
- Semi-trailers.

The most common type of refrigerated vehicle used in humanitarian contexts is the single unit refrigerated box truck, usually referred to as a “reefer truck”, however this may vary from context to context.

*Example refrigerated box truck, with insulated walls and self-contained freezer unit at the highest point of the container.*



It is highly unlikely that humanitarian organisations will directly own their own reefer trucks or other refrigerated vehicles unless there is a fully dedicated project that would justify the expense. In the event that the vehicle is owned, humanitarian organisations should refer to the [fleet management](#) section of this guide consider all regular requirements associated with [maintaining their own trucks](#).

In the highly likely event that humanitarian organisations contract third-party transport

services to utilise a refrigerated road vehicle for transport, they should consider [the normal procedures associated with contracting any trucking service](#). Additionally, there are a few additional contractual terms they should consider when soliciting third party refrigerated vehicles.

## **Contracting Third Party Refrigerated vehicles:**

### **Recommended Terms - Temperature-Controlled Movements / Requirements**

In the case of the movement of temperature-controlled goods, the following terms are recommended for contracting and soliciting third party refrigerated vehicles.

- If required, the contracted trucking company should ensure that the cooling units have been programmed for permanent run prior to loading per instructions.
- Contracted trucking company should ensure a copy of a valid calibration report is present in the truck.
- Contracted trucking company should ensure the driver maintains an activity sheet where temperature readings are recorded at every transition / touch point / stop point.
- Drivers should remain present at the dock area while goods are being loaded at origin and offloaded at destination.
- Drivers should ensure doors are closed immediately after loading. Doors should be barred and locked if required.
- Whenever the trailer doors have to be opened, including but not limited to loading, offloading, they should be closed immediately after-wards to avoid temperature disparities.
- In case of any customs or third-party inspection, the contracted trucking company should inform contracting agency immediately, detailing door opening and closing duration and the temperature readings should be recorded on the activity sheet.
- The contracted trucking company should provide calibrated and proper functioning reefer equipment and ensure the driver checks the temperature and the reefer equipment's running status at every stop.
- In case of irregularity / temperature variance the contracted trucking company should inform the contracting humanitarian agency immediately.
- The contracted trucking company should make sure the drivers do not remove any temperature monitors / data recorders once they are placed inside the trailer until the truck reaches the point of delivery.
- The contracted trucking company has to ensure temperature monitors / data recorders are to be brought back after delivery.

### **Temperature Variances / Deviations**

- In case of deviations from the terms and conditions contained in this agreement/contract the driver should notify the contracted trucking company, who should communicate this with the contracting humanitarian agency immediately.
- The contracted trucking company should make sure an investigation is done in case of a complaint / temperature variation issue is raised by the contracting humanitarian agency with regards to the temperature variances.
- In any case of claim/complaints the contracted trucking company and contracting humanitarian agency will study the case, should provide the corrective and preventive actions and then proceed with the claim process and procedures.

### **Maintenance and Calibration**

- The contracted trucking company should ensure the reefer system used for transporting temperature-controlled goods should undergo regular preventive maintenance.
- The contracted trucking company should ensure the reefer trucks used are calibrated annually and should be certified.
- Contracted trucking company should provide the contracting humanitarian agency with the records of truck maintenance and calibration certificates upon request.

A general checklist on how to enact road shipments using a refrigerated vehicle can be found below:

***Pre-shipment actions:***

- Specify temperature requirements.
- Prepare shipping documentation and checklists, especially as it pertains to transport of specialty medical items.
- Ensure that the designated vehicle is in good working order, that its service record is up-to-date, and that the driver has carried out the relevant daily safety inspection.

***Shipping day: actions at point of origin:***

- Pack the product in its correct tertiary package and attach temperature-monitoring devices to suit the routing requirements. Keep product under proper storage conditions until the time of dispatch.
- Ensure that the vehicle is fully operational, and that the cargo area is clean and odour-free.
- Prior to loading, the trailers should be at the temperature required for transport. Loading should only be initiated when the temperature reaches the set point requested by the contracting humanitarian agency.
- Keep loading door(s) closed until it is time to load the product.
- Ensure that the thermostatic controller on the transport vehicle is set to the required temperature and ensure that the temperature recording device(s) are operating properly.
- Check that the vehicle's refrigeration unit is operating properly, and that the temperature has stabilised. Drivers must ensure that the correct temperature setting has been selected.
- Load product without delay. Do not overload the vehicle. Allow for air circulation around all sides of the product. Properly block and brace the load, as shown in Annex 1, to avoid shifting during transit. Close door(s) and apply security seal and/or lock if required.
- Whenever possible, ensure that the driver is able to supervise the loading process.
- If the refrigeration unit has been operating on mains electric power during loading, make sure that the engine-powered refrigeration system is operating correctly, and that the temperature has stabilised within predefined limits before releasing.
- Provide clear instructions to the driver concerning the correct load temperature, handling and transport requirements.
- Provide emergency contact information to the driver.

---

**Actions during transit:**

- Cooling units must remain active throughout the entire journey, including during stops and rest periods.
- Energy-saving modes/options of the cooling unit should not be used.
- Vehicle payload doors must only be opened during loading and unloading and opening time must be kept to a minimum.
- Minimise the time during which the vehicle is unattended by the driver.

---

**Arrival day: actions at destination point(s):**

- Ensure priority unloading.
- Remove product from the vehicle and move it immediately to a location providing the correct temperature-controlled storage conditions.
- Retrieve temperature data from the driver.
- (where possible) When the product is received, the consignee should retrieve and deactivate the temperature monitors accompanying the shipment and read and download the data. *Note:* If temperature monitors are not packed with the product, the data from the on-board temperature recording system should be downloaded, or a print-out obtained from the driver and attached to the arrival forms.
- Ensure all checklists and arrival forms are completed by the responsible parties.

---

Adapted from: [WHO - Temperature-controlled transport operations by road and by air](#)

It is very common for refrigerated vehicles to be opened and undergo inspection when crossing borders, or when operating around intense insecurity. Persons sending items using refrigerated vehicles should anticipate situations when enhanced inspection might happen, and how that might impact transported cargo.

## Reefer Containers

A reefer container is a variation on a [standard shipping container](#) used in maritime operations, only with the capacity to maintain a constant temperature. Much like refrigerated trucks, reefer containers have self-contained freezer/refrigerator units, and proper insulation. Reefer containers can be transported on the backs of trucks, mounted onto the decks of sea vessels, or even be used as storage facilities.

Reefer containers usually come with both external power connections and self-contained motors used to power refrigeration equipment. As containers are moved, it's the responsibility of the transporter to ensure that the reefer produces constant power and will maintain a temperature to the relevant set-point. Reefer containers can be plugged directly into the electrical systems of large sea vessels, trucks or buildings. Where external power isn't available, reefers – depending on the container – reefers may be able to run an internal motor off of petrol or diesel, however the motors will have to be refuelled and maintained while the items are in transit.

## Reefers and Sea Shipping

When reefer containers are utilised for sea shipping, they are almost always owned by either the shipping line, or an intermediary broker. Typically, the use of the reefer container is negotiated using a freight forwarder, and the overall loading and handling of the container is

done outside of the control of the organisation or individual sending refrigerated items via ocean. In many cases, owners of refrigerated cargo won't even be involved with stuffing containers.

*Example reefer container:*



All reefer containers used for sea shipping must undergo what is known as a pre-trip inspection (PTI). Unless the reefer container is owned by the sender of the cargo, PTIs are undertaken by the shipping company. PTIs validate the condition of the container, the refrigeration equipment, and the monitoring equipment, and are rated for 30 to 120 days, depending on the needs of the shipping line and policies of the company.

Humanitarian organisations planning on using reefer containers to transport health supplies should still endeavour to inspect the container wherever possible.

- Even if a PTI is conducted by the transport company, shippers may request their own inspection if necessary, and include them in their own transport contracts.
- It is also advisable that organisations shipping cargo via reefer include the obligation of the shipping line to conduct a PTI in the contract – though the failure to fully conduct a PTI may ultimately be the responsibility of the shipping line, having a written agreement outlining the need for a PTI is still advisable.
- Organisations shipping cargo via reefer may also ask for copies of any monitoring reports that are produced throughout the shipping process. There may even online/real time monitoring capacity available through the transport company.

## **Reefers as Permanent Storage**



Many organisations in humanitarian settings have opted to use reefer containers as permanent storage structures. The use of reefers as storage facilities can be very useful where no other infrastructure is available, however it is still always advisable to investigate permanent hard sided buildings capable of being retrofitted to maintain the required temperature ranges.

If a reefer container is to be kept as a permanent storage structure, there are a few things to consider:

- **Power** - Wherever possible, reefers should be plugged directly into the power grid, or a large enough generator to maintain the power needs of the unit. Though sea shipments might take months to complete, the on-board motor isn't designed for permanent usage. If the on-board motor is used to maintain a reefer's set point, the output exhaust cannot be into an enclosed space, like a larger warehouse.
- **Interior Set Up** - Though reefers are used for transport, they are not directly designed for storage. This means that the floors of the container might not be conducive to shelving or rolling handling equipment. Additional flooring may need to be installed to accommodate storage needs.
- **Doors** - Reefer containers were designed to be opened infrequently, and using one as a storage facility may lead to excessive heat loss as the large doors may be opened more frequently. Plastic flaps might need to be installed in the interior to reduce heat loss.
- **Temperature Monitoring** - Organisations using a reefer as a storage facility will still want to conduct a heat mapping exercise and develop some type of monitoring to ensure that products are still properly maintained.
- **Foundation Placement** - Organisations using reefer containers as storage should ensure that containers are placed on a raised hard surface (usually concrete foundation) or at the very least hard packed soil on raised ground to prevent rain damage.

## Air Transport Containers

Use of active cooling containers for the transport of temperature-controlled medical items by air requires some additional preplanning. Where air transport using passive cooling containers entails handing self-contained insulated containers directly to air carriers, active cooling air transport containers provide powered temperature regulation directly in the container itself, either powered by direct connection to the electrical system of the air frame, or through a dedicated battery solution.

There are a variety of active cooling air transport containers, usually specified to conform to different types of aircraft. The range of active cooling air transport containers can be from smaller standalone crates to specifically shaped [unit load devices \(ULDs\) use in common commercial air transport](#). It is highly unlikely that personnel from a humanitarian aid organisation will ever be involved with loading or handling air transport containers - usually temperature-controlled air transport containers are managed by the ground crew and/or load master, and the equipment itself may only be leased from the manufacturer.

*Example temperature-controlled ULD:*



## Passive Cold Chain Transportation

Passive cold chain transportation methods broadly refer to any method of transportation of cold chain items that does not involve outside power or maintenance. Passive systems are self-contained and are prepared at the point of origin without continued management by the transporter, other than some basic duty of care.

## Passive Cold Chain Containers

Some medical related relief items – such as vaccines and other lifesaving medications – rely heavily on passive cold chain containers for transport in humanitarian field settings. Passive cold chain containers are insulated carries, usually with accompanying ice packs and/or freeze packs, which require no external power or mechanical support and are especially useful in humanitarian contexts where persistent electrical connectivity or advanced infrastructure may not be available or actively working. Passive cold chain containers - either single use disposable or reusable depending on the context - and are only meant to keep cargo items in a pre-defined temperature range for a limited period of time, between 12 hours and 120 hours depending on the container and the external ambient temperature. Please note, the actual duration of passive container will depend on the container and the real-world conditions on the ground. For relatively short transit times, such as single day car rides, or movement via helicopters, passive cold chain containers are ideal for transporting small quantities of items.

There are two main type of devices - reusable containers (cold boxes and vaccine carriers) and disposable boxes. Note: the term “disposable” does not mean these types of insulated boxes can only be used one, they only refer to the easily disposable nature of the materials. Disposable insulated boxes are frequently reused multiple times in single operation.

**Cold Boxes** – Insulated reusable containers that loaded with coolant packs are used to transport supplies between different medical stores or to health facilities. They are also used to temporarily store items when the refrigerator is out of order or being defrosted.

The storage capacity of cold boxes ranges between 5 and 25 Litres and its cold life can vary from a minimum of 48 hours to a minimum of 96 hours (known respectively as “short range” and “long range” cold boxes).



**Vaccine Carriers** - Insulated reusable containers that, when lined with coolant packs, keep vaccines (and diluents) cold during transportation from health facilities with refrigeration to vaccination sites where refrigeration and ice are not available. They are smaller than cold boxes and therefore easier to carry by a single health worker travelling on foot or by other means, where the combined journey time and immunisation activity ranges from a few hours to a whole day. The storage capacity of vaccine carriers is between 0.1 and 5.0 Litres.



**Disposable Insulated Boxes** - (also known as Insulated shipping containers) Insulated containers, manufactured in carton or moulded foams such as polyurethane, polyethylene or expanded polystyrene (EPS). Some are designed for single use while others are returnable for reuse. They are used for the transport of items over long distances. Their storage capacity, temperature range, cold life and resistance vary among different solutions: some solutions are suitable for Road transport with hold on times between 36-48 hours while some other solutions are suitable for air transport with hold on times up to 120 hours. One main concern related to

disposable insulated carton boxes is its single-use lifespan and its low-cost material composition of EPS and water-based gel packs, rarely recyclable.



Disposable insulated carton boxes are used by manufacturers to ship products with sensitive cold chain needs around the world. Disposable insulated containers must conform to certain standards, and often have a cold life often with a maximum of 4 days. Insulated containers are regulated by WHO prequalification standards.

Three categories of packaging are used for international air freighting (listed below in decreasing order of bulk):

**Class A** Packaging is designed to ensure that the temperature of the item does not rise above +8°C for a minimum exposure of 48 hours at an ambient temperature of 43°C.

---

**Class B** Packaging is designed to ensure that the temperature of the items does not rise above +30°C for a minimum exposure of 48 hours at an ambient temperature of 43°C. It must also prevent the temperature of the items from dropping below +2°C for a minimum of 48 hours at an ambient temperature of -5°C.

---

**Class C** Packaging provides no specific protection against high temperatures. However, it must prevent the temperature of the item from dropping below +2°C for a minimum exposure of 48 hours at an ambient temperature of -5°C.

---

No matter the type of passive insulated carrier used, it is recommended that each insulated carton should weigh less than 50kg to ensure ease of handling during transport as they are frequently loaded and offloaded manually.

## Pallet Shippers

Pallet shippers are passive insulated packaging that is specifically designed to cover or encompass entire pallets of cold chain related items. Pallet shippers can come in the form foam insulation, cardboard, or some form of thermal resistant fabric. Pallet shippers are used mostly by commercial providers shipping bulk volumes of cold chain required medical products.

*Example pallet shippers:*

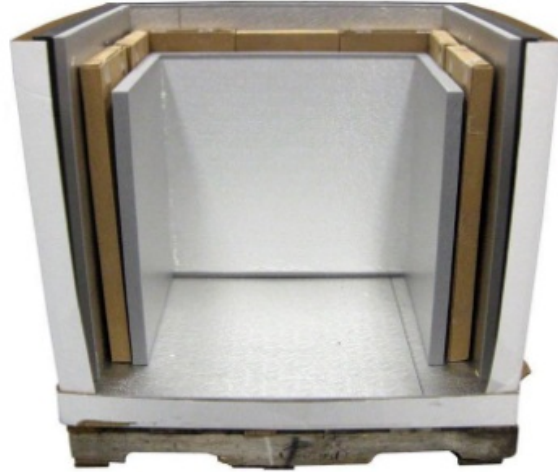

Pallet shippers have a built-in wooden or plastic pallet platform to enable handling and transport by forklift or pallet handling equipment. Pallet shippers will generally accommodate higher volumes per unit. Where used or ordered, it is recommended that external dimensions of pallet shippers should not exceed [standard ISO pallet sizes](#), while also not exceeding not exceed 160 cm in height. Height requirements may vary on the context, but 160 cm is generally the maximum height a pallet can be to fit as a single unit into most aircraft. Shippers should understand the ultimate transport requirements prior to using pallet shippers. Under no circumstance should pallet shippers be depalletized in transport, or double stacked!

## Transporting Passive Cold Chain Containers

Irrespective of the method, transportation of passive cold chain containers generally should follow a few key steps:

- Wherever possible, passive cold chain containers and boxes should be covered, and kept away from direct sunlight.
- Containers should be kept away from ambient heat sources of excessive heat (such as engines)
- Transportation times should be kept well within the allotted limit of the passive keep cool container. Ideally, maximum transport times should not exceed 2/3 the anticipated duration of the capacity for the container to keep items cool. In many cases, transport times should also be based on the anticipated return journey times, in case cargo items are rejected or may not be able to offload for a variety of reasons.
- Persons receiving the passive containers should be notified in advance and be waiting at the reception area.
- Depending on the nature of the operation, or the requirements for the cargo items, temperature monitoring devices may be included. For more information on monitoring devices, please reference the section on [temperature monitoring](#) in this guide.

Additionally, a general checklist for transporting passive cold chain containers might include:

**Pre-shipment actions:**

- Ensure that there are sufficient quantities of all packaging components to accommodate the shipment on the shipping day.
  - Ensure that all components have been conditioned to the correct temperature (i.e. temperature-stabilising media, whether frozen or refrigerated). Instructions on conditioning of passive keep cool boxes depends on the type of container used, and usually is different in "summer" and "winter" ambient temperature conditions.
  - Ensure that the designated vehicle is in good working order, that its service record is up-to-date, and that the driver has carried out the relevant daily safety inspection.
- 

**Shipping day – actions at point of origin:**

- Prepare and pack product in its designated secondary or ancillary packaging.
  - Assemble the passive shipping system and pack and load the product in accordance with approved site procedures.
  - Add temperature dataloggers or temperature indicators if required. Place in close proximity to the product. Do not allow them to come into contact with temperature-stabilising media, such as ice packs.
  - Ensure that all paperwork and checklists are completed by the responsible parties.
- 

**Actions during transit:**

- Where appropriate, vehicles should be parked in a secured parking area during rest stops; wherever possible, vehicles should be parked in the shade.
  - Containers must not be opened during transit.
- 

**Arrival day: actions at destination:**

- Open packaging, remove product from its passive shipping system and move it immediately to the correct temperature-controlled storage conditions.
  - Retrieve and deactivate temperature monitors for data retrieval.
  - Ensure all checklists and arrival forms are completed by responsible parties.
- 

**Post-shipment actions:**

- Forward completed checklists to appropriate personnel, including electronic temperature data files.
  - Dispose of, recondition or reuse packaging as appropriate.
- 

Adapted from: [WHO - Temperature-controlled Transport Operations by Road and by Air](#)

## **Planning Passive Keep Cool Container Transport**

### **Use of Portable Passive Keep Cool Containers**

Due to infrastructure and logistics constraints in some locations, it is advised to assess the logistics capacity of downstream reception facilities prior to shipping. In case of limited logistics capacity, it is preferable to ship keep cool items using individual insulated cartons.

Reusable containers generally used to transport keep cool items from one fixed store to another, and from central stores to health facilities. They have a storage capacity between 5.0 and 25.0 litres.

**Cold Boxes**

There are two types of cold boxes:

- Short range: With a minimum cold life of 48 hours.
- Long range: With a minimum cold life of 96 hours.

---

**Vaccine Carriers**

Used for transporting vaccines where the combined journey time and immunisation activity ranges from a few hours to a whole day. The vaccine storage capacity of vaccine carriers is between 0.1 and 5.0 litres.

---

When choosing means for transport of keep cool items, consider the following factors:

- The heat and freeze sensitivity of every keep cool item being transported, especially vaccines. If available, refer to manufacturer indications for further information on temperature sensitivity of the items. In any other case refer to WHO *How to use passive containers and coolant-packs*.
- The required cold life to keep transported keep cool items at safe temperatures for an entire transport or outreach session. For vaccination outreach sessions the considered time should include travel to and from the vaccination site, allowing the safe management of non-used vaccines.
- The required capacity based on the volume of keep-cool items to be transported.

When selecting the appropriate container, the time of transport must be considerably less than the cold life of the container. Unexpected events such as vehicle breakdowns, human error or carelessness, often delay the time of transport. When the duration of the journey exceeds the cold life of the container, it is possible to replace the coolant packs if necessary. The back-up coolant packs can be transported in a separated container or swapped in a stop-by storage facility with compatible coolant packs. It is therefore necessary not to compromise on the number of ice packs which may need to be prepared.

### **Coolant Packs**

Once the decision about the type of container is taken, calculate the number of cold boxes required. Subsequently calculate the number of coolant packs and temperature tracking and alert devices required. Each container holds a specific number of coolant packs.

In regular cold chain management, it is recommended that every cold box or vaccine carrier should have at least two sets of coolant packs, allowing one set of the packs to be cooled, while the other set is being used in the cold box or vaccine carrier. Note that one set of coolant packs is normally provided with each procured cold box or vaccine carrier, so that one additional set at least needs to be ordered.

The type of coolant packs must be selected according to the container and the required temperatures. Ideally, they should be compatible with other coolant packs used in the country.

There are several types of coolant packs:

<b>Water-Filled Coolant Packs</b>	The most commonly used, they are available in a solid rectangular plastic container in different sizes. The most common are: 0.3 litres (in two different sizes: 173x120x26mm and 163x90x34mm), 0.4 litres (163x94x34mm) and 0.6 litres (190x120x34mm). They are used to maintain temperatures in reusable cold boxes or vaccine carriers. WHO currently recommends the use of water-filled coolant packs. Drinking water is safe for such use and is generally available; this makes it the most practical substance for filling coolant packs because both water and ice can effectively control the temperature of the load, when correctly used.
<b>Gel-Packs</b>	sealed coolant containers pre-filled with a mixture of water and additives. They are available in flexible plastic bag or in a rectangular plastic container. WHO does not recommend using gel-packs because their thermal properties - freezing point of some gel-packs can be significantly below 0°C - and their lower durability.
<b>Phase-Change Material Packs (PCM-packs)</b>	containers filled with other phase-change materials different from water. They can be designed to change phase at the convenient temperatures range, overcoming the risk associated with frozen water. However, they are also more expensive, and their conditioning process is longer and more complex.

Depending on the urgency of the item, manufacturers of cold chain and keep cool items ship products by air using coolant-packs of various types and sizes containing various fill materials, including water, gel and PCM. It is a common practice to reuse these coolant packs recovered from international shipping containers. WHO discourages this practice as these packs do not necessarily perform in the same way as the water-packs. In addition, they are not designed for repeated use and may not be dimensionally compatible with most of the passive containers used for the in-country supply chain. The recommendation is that these packs are removed from the receiving keep cool items and recycled or disposed of according to the manufacturer's recommendations and/or national waste management policies.

### Conditioning Water-Packs

The temperature of coolant packs must be set according to the temperatures required by the keep cool items to be shipped. There are two main possibilities:

- The items to be shipped in the cold box may be frozen. Examples: vaccines for Measles, Polio, Yellow fever, Meningitis, etc.
- The items to be shipped in the cold box will be irreversibly damaged when frozen. Examples: Oxytocin, vaccines for DTP, DT, Td, TT, Hep A and Hep B, Hib.

To understand if items can be safely frozen or not, consult the manufacturer's guidelines. If all items to be shipped in the cold box may be frozen, frozen coolant packs can be directly transferred from the freezer to the cold box.

In the case that items will be damaged when frozen, the coolant packs need to be "conditioned" before being transferred into the cold box. That means bringing its temperature up to 0°C. The conditioning of coolant packs consists of laying the required number of frozen icepacks on a table or work surface (preferably not under direct sun light) and waiting until they all reach 0°C. This may take at least 30 to 45 minutes in hot weather and much longer in cool conditions (from 90 to 120 minutes at +20°C). In order to know when the icepacks are ready to be used, there must be liquid water inside every pack and the ice cores should be able to move freely inside the packs when shaken. To ease the process, place the icepacks in one



single layer and separated from each other.

The use of cool water-packs and warm water-packs can be pertinent for some shipments. Warm water-packs are used to protect freeze-sensitive items in countries where temperatures are frequently below 0°C. Warm water-packs are to be prepared at a room temperature between +18°C and a maximum of +24°C. Cool water-packs are to be prepared in a refrigerator at a temperature of no more than +5°.

### **Packing Keep Cool Containers**

The first action during packing is to dry any droplets on the coolant packs surface and placing it in a cold box according to the cold box manufacturer specifications: the correct size and number of coolant-packs must be used. The technical sheet for loading the cold box is often available inside each box.

Place the keep cool items inside the cold box, putting cardboard between thermo-sensitive products and icepacks to prevent them touching. Make sure that any remaining space is filled with packing material to avoid damage during onward transport.

When packing keep cool items without secondary package/carton box (common practice when using vaccine carriers), put the items and diluents in a plastic bag in the middle of the cold box or carrier to protect them from damage due to condensation.

Place the required temperature monitoring devices in the box or carrier. Do not allow monitoring devices to come into contact with coolant packs. If using a thermometer in the container, place it in a visible and easily accessible place to avoid long content handling during temperature checks.

When required, put the top layer of coolant packs and close the container.

### **Calculating Volumes for Vaccine Shipments using Keep Cool Boxes**

To calculate the volume of vaccine to be shipped, it is necessary to know for each vaccine and diluent in the shipment:

- The required storage temperature: 3 ranges of temperature are normally considered for vaccine transportation: -15°C to -25°C, +2°C to +8°C or ambient.
- The number of doses to be transported.
- The packed volume per dose (cm<sup>3</sup>/dose). The packed volume includes the vaccine vial, the packet containing the vaccine vial and any intermediate packaging (secondary packaging).

The maximum recommended packed volume per vaccine dose and diluents are:

Vaccine type	Dose per vial	cm <sup>3</sup> per dose
BCG (freeze-dried)	20	1.2
	10	3.0

<b>DTP Vaccine Type</b>	<b>Dose per vial</b>	<b>cm3 per dose</b>
	<b>20</b>	<b>2.0</b>
<b>DTP-HepB</b>	<b>2</b>	<b>6.0</b>
	<b>10</b>	<b>3.0</b>
<b>DTP-Hib</b>	<b>10</b>	<b>2.5</b>
<b>DTP+Hib (freeze-dried)</b>	<b>1</b>	<b>45.0</b>
	<b>10</b>	<b>12.0</b>
<b>DTP-HepB+Hib (freeze dried)</b>	<b>1</b>	<b>22.0</b>
	<b>2</b>	<b>11.0</b>
<b>HepB</b>	<b>1</b>	<b>18.0</b>
	<b>1 in UNJECT</b>	<b>30.0</b>
	<b>2</b>	<b>13.0</b>
	<b>6</b>	<b>4.5</b>
	<b>10</b>	<b>4.0</b>
	<b>20</b>	<b>3.0</b>
<b>Hib (liquid)</b>	<b>1</b>	<b>15.0</b>
	<b>10</b>	<b>2.5</b>

<b>Vaccine type</b>	<b>Dose per vial</b>	<b>cm3 per dose</b>
<b>Hib (freeze-dried)</b>	<b>1</b>	<b>13.0</b>
	<b>2</b>	<b>6.0</b>
	<b>10</b>	<b>2.5</b>
<b>Measles (freeze-dried)</b>	<b>10</b>	<b>3.5</b>
<b>MMR (freeze-dried)</b>	<b>1</b>	<b>16.0</b>
	<b>10</b>	<b>3.0</b>
<b>MR (freeze-dried)</b>	<b>10</b>	<b>2.5</b>
<b>Meningitis A&amp;C</b>	<b>20</b>	<b>2.5</b>
	<b>50</b>	<b>1.5</b>
<b>OPV</b>	<b>10</b>	<b>2.0</b>
	<b>20</b>	<b>1.0</b>
<b>TT in UNJECT</b>	<b>1</b>	<b>25.0</b>
<b>Yellow fever</b>	<b>5</b>	<b>6.5</b>
	<b>10</b>	<b>2.5</b>
	<b>20</b>	<b>1.0</b>
<b>Diluent for BCG</b>	<b>20</b>	<b>0.70</b>

Vaccine type	Dose per vial	cm <sup>3</sup> per dose
Diluent for Hib	1	35.0
	10	3.0
Diluent for measles, MR, MMR	1	20.0
	10	4.0
Diluent for meningitis A&C	20	2.5
	50	1.5
Diluent for yellow fever	5	7.0
	10	6.0
	20	3.0
OPV droppers	n/a	17.0 (per unit)
Diluent for BCG	20	0.70

Be aware that the volume obtained from multiplying the packed volume per dose by the number of doses only takes into consideration the primary and the secondary packages: it doesn't include the cold box packaging. Estimating the final transport volume (including the cold box) is necessary to correctly plan the transport means. For this purpose, a transport box bulking factor can be used. The bulking factor depends on the type of vaccine. WHO *Guideline for establishing or improving primary and intermediate vaccine stores*, recommends the following transport box bulking factors:

- BCF, OPV, measles, MMR, MR = 6.0
- Other vaccines = 3.0
- Diluent, droppers = 1.5

**Type of Vaccine** – The type of vaccine is of key importance because different vaccines have different presentations. The most common are vials (or ampules), however single-dose pre-filled syringes may be used in humanitarian operations. Depending on the vaccine, vials can

contain different number of doses, normally 1, 10 or 20 doses. The key variables used to calculate the required volume for vaccine storage and transport are the number of doses to be stored and the estimated volume per dose. The estimated volume per dose (or packed vaccine volume) quantifies the space needed to store or transport vaccines and diluents and will depend on the number of doses per vial, the physical size of the vial or ampule (primary package) and the bulkiness of the external packaging (secondary packages).

*Example multi-dose vaccine vial:*



*Example single-dose pre-filled vaccine syringe:*



Some presentations include the diluent in the same packaging as the vaccine. In such cases it is necessary to refrigerate the diluent as well as the vaccine. In all cases, diluents should be refrigerated 24h prior to vaccine preparation. Refrigeration of diluents is normally done in the last step of the vaccine supply chain.

Whenever possible, the packed vaccine volume per dose should be calculated using data from the vaccine manufacturer or supplier. It is also recommended to use the WHO guidance document for vaccine volume calculation: [How to calculate vaccine volumes and cold chain capacity requirements](#).

## Transportation of Clinical Samples

Humanitarian logistics personnel may be required to organise the transportation of clinical samples from the outbreak location to a reference laboratory may be required, especially

during disease outbreaks, such as Ebola Haemorrhagic Fever. The transportation of samples is usually handled by either the local government, or by a WHO representative, or by a specialised agency tasked with the process in the local context.

Clinical and biological samples are considered "dangerous goods", and transport of these is subject to very strict regulations. Before transporting clinical samples always consult local regulations and international best practice. Commercial air and sea transporters will often have clear guidelines on the transportation of clinical and biological samples – reference the [dangerous good section of this guide](#) for more information. In absence of a clear local regulation, humanitarian agencies might refer to WHO's "[Guidance on regulations for the transport of Infectious Substances](#)".

Biologic samples are separated into two different categories when prepared for shipping:

<b>Category A</b>	An infectious substance which is transported in a form that, when exposure to it occurs, is capable of causing permanent disability, life-threatening or fatal disease in otherwise healthy humans or animals. If a Category A substance were released from the craft carrying it and/or protective packaging used during the transportation, it could have severe consequences on the health of any humans or animals that came in contact with it.
<b>Category B</b>	Infectious substances that contain biological agents, capable of causing infection in humans or animals, but NOT meeting the criteria for Category A (i.e. the consequences of an infection are not considered severely disabling or life-threatening).

Adapted from: [WHO's - Guidance on regulations for the transport of Infectious Substances](#)

## Packaging

Both Category A and Category B substances have their own forms of approved packaging, and all samples must be transported in their respective approved packaging, usually some form of triple packing. Consider that in some contexts, this type of packaging won't be available to be purchased locally. Certain health actors or specialised medical agencies may have stock available.

The system for transporting samples consists of three layers:

1. Primary container containing the sample: Tube or bottle tightly closed and labelled.
2. Secondary container intended to protect the primary container: Waterproof box/tube (Category A) or plastic bag (Category B) with enough absorbent material to absorb all the liquid in case of breakage.
3. Outer packaging intended to protect the secondary container: Reinforced cardboard box with UN labelling.

*Example Packaging for "Category A" Biological Samples*

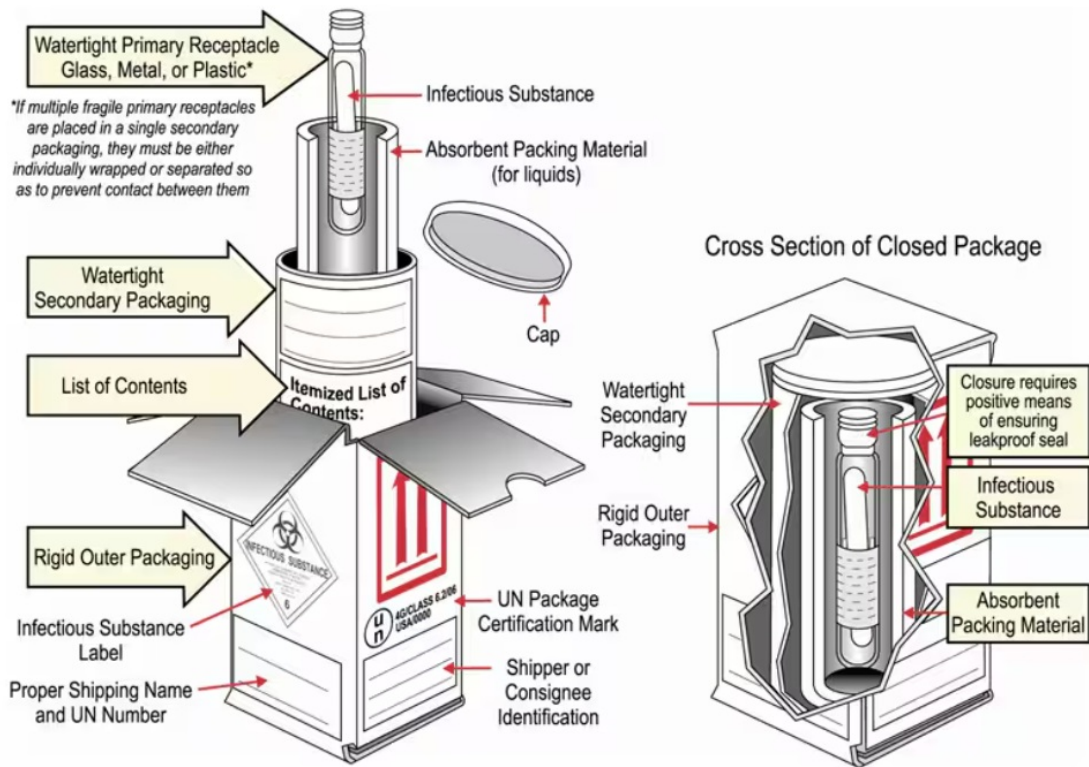

**Example Packaging for "Category B" Biological Samples**

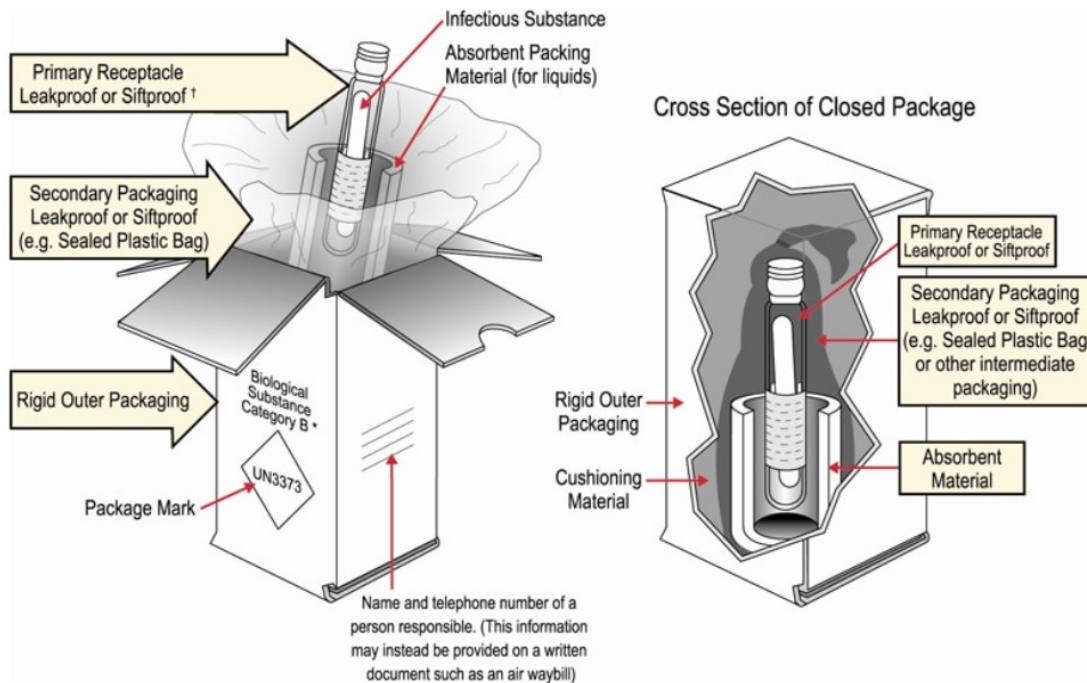

The choice of container depends on the classification of the sample to be transported and whether or not it is necessary to transport the sample at controlled temperature; some samples will require +2°C to +8°C temperature.

Usually, individual transported biological samples will be uniquely identified with information such as the name or patient code number and date/place of collection and will be accompanied by relevant clinical and epidemiological information. Information to be contained on the on the outer packaging of the box should include:

- Shipper.
- Consignee.
- Emergency contact: mention the name and the phone number of the person to contact in case of emergency (i.e., incidental opening or leakage).
- UN approved marking and product category/class.
- Net capacity of sample only.
- Mandatory marking: "Infectious substance" logo and additional required approval markings.

The shipper is responsible for classifying, declaring, packaging and labelling the samples. Any transporter or service provider involved in the transportation chain, must be informed about the material being sent. If there is any problem during the transport, the shipper must be able to prove that he has strictly followed the regulations. If humanitarian organisations organising the transport of biological samples have any questions on labelling, they may also consult their freight forwarder or transport company.

The person enacting the shipment be sure to inform the receiving party in advance, specifying the nature of the sample as well as the planned shipping date to ensure readiness to receive the sample. In some cases, biological samples will be delivered to third party laboratories or government offices who may have very little understanding of the humanitarian operation. Shippers should also tell transport companies well in advance as well, as they may have their own protocols for handling and managing these types of shipments.

Below is a list of UN ID numbers and packing instruction per category that should be included with every shipment.



UN No.	Proper Shipping Name	Category	Hazard Class	Packing Instructions
UN2814	Infectious substance affecting humans	Category A	6.2	620
UN2900	Infectious substances affecting animals	Category A	6.2	620
UN3549	Medical waste, Category A, affecting animals only, solid	Category A	6.2	622
UN3549	Medical waste, Category A, affecting humans, solid.	Category A	6.2	622
UN3291	Biomedical waste, n.o.s., Clinical waste, unspecified, n.o.s. or medical waste, n.o.s. or regulated medical waste, n.o.s.	Category B	6.2	621
UN3373	Biomedical Substance Category B	Category B	6.2	650

More information on identifying dangerous goods categories can be found in the [dangerous goods section of this guide](#).

## Health Supply Chain Tools and Resources

### Templates and Tools

- [TEMPLATE - Cold Chain Temperature Monitoring Chart](#)
- [HHS - Emergency Response Medical Logistics Operational Toolkit](#)

### Sites and Resources

- [Approved essential medicines per country](#)
- [Basel Convention on the Control of Transboundary Movements of Hazardous Wastes](#)
- [DG ECHO - Review of quality assurance \(QA\) mechanisms for medicines and medical supplies in humanitarian aid](#)
- [ICRC - Medical Waste Management Guidelines](#)
- [Immunizationacademy.com](#)
- [JSI - Guidelines for the Storage of Essential Medicines and other Health Commodities](#)

- [MSF - Cold Chain Evaluation](#)
- [PATH - Total Cost of Ownership Tool for Cold Chain Equipment](#)
- [PATH / WHO - Delivering Vaccines: A Cost Comparison of In-Country Vaccine Transport Container Options](#)
- [Stockholm Convention on Persistent Organic Pollutants \(POPs\)](#)
- [Technical Network for Strengthening Immunization Services](#)
- [USAID - Logistics Handbook, A Practical Guide for the Supply Chain Management of Health Commodities](#)
- [UNICEF - Cold Chain Technical Support](#)
- [UNICEF / WHO - Effective Vaccine Store Management Initiative](#)
- [UNICEF - Procurement Guidelines for Walk-In Cold Rooms And Freezer Rooms](#)
- [UNICEF - Procurement Guidelines, Compression System Refrigerators and Freezers](#)
- [UNICEF - Procurement Guidelines, Solar Direct Drive Refrigerators and Freezers](#)
- [UNICEF - Procurement Guidelines, Temperature Monitoring Devices](#)
- [UNICEF - Procurement Guidelines, Vaccine Carriers and Cold Boxes](#)
- [UNICEF / WHO - Decommissioning and Safe Disposal of Cold Chain Equipment](#)
- [WFP Logistics Cluster - Downstream Logistics in Pandemics](#)
- [WHO - Effective Vaccine Management \(EVM\) model standard operating procedures](#)
- [WHO - Expert Committee on Specifications for Pharmaceutical Preparation](#)
- [WHO - Interagency Emergency Health Kit](#)
- [WHO - Guidelines on the International Packaging and Shipping of Vaccines](#)
- [WHO - Guideline For Establishing Or Improving Primary And Intermediate Vaccine Stores](#)
- [WHO - Guidelines for Medicine Donations](#)
- [WHO - Guidance on Regulations for the Transport of Infectious Substances](#)
- [WHO - How to Monitor Temperatures in the Vaccine Supply Chain](#)
- [WHO - How to calculate vaccine volumes and cold chain capacity requirements](#)
- [WHO - How to use passive containers and coolant-packs, 2015](#)
- [WHO - Introducing Solar-powered Vaccine Refrigerator and Freezer Systems, A Guide for Managers in National Immunization Programmes](#)
- [WHO - Immunization in practice: A practical guide for health staff. Geneva](#)
- [WHO - Model List of Essential Medicines](#)
- [WHO - Performance, Quality and Safety \(PQS\)](#)
- [WHO - Safe Disposal of Unwanted Pharmaceuticals](#)
- [WHO - Safe Management of Wastes from Health-Care Activities](#)
- [WHO - Solar direct-drive vaccine refrigerators and freezers](#)
- [WHO - Selection of Essential Medicines at Country Level](#)
- [WHO - Study protocol for temperature monitoring in the vaccine cold chain](#)
- [WHO - Supplement 01 - Selecting sites for storage facilities - May 2015](#)
- [WHO - Supplement 02 - Design of storage facilities - May 2015](#)
- [WHO - Supplement 03 - Estimating the capacity of storage facilities - May 2015](#)
- [WHO - Supplement 04 - Security and fire protection in storage facilities - May 2015](#)
- [WHO - Supplement 05 - Maintenance of storage facilities - May 2015](#)
- [WHO - Supplement 06 - Temperature and Humidity Monitoring Systems for Fixed Storage Areas - May 2015](#)
- [WHO - Supplement 07 - Qualification of Temperature-controlled Storage Areas - May 2015](#)
- [WHO - Supplement 08 - Temperature Mapping of Storage Areas - May 2015](#)
- [WHO - Supplement 09 - Refrigeration equipment maintenance - May 2015](#)
- [WHO - Supplement 10 - Checking the accuracy of temperature control and monitoring devices - May 2015](#)
- [WHO - Supplement 11 - Qualification of refrigerated road vehicles - May 2015](#)
- [WHO - Supplement 12 - Temperature-controlled Transport Operations by Road and by Air](#)

[- May 2015](#)

- [WHO - Supplement 13 - Qualification of shipping containers - May 2015](#)
- [WHO - Supplement 14 - Transport route profiling qualification - May 2015](#)
- [WHO - Supplement 15 - Temperature and humidity monitoring systems for transport operations - May 2015](#)
- [WHO - Supplement 16 - Environmental management of refrigerant gases and refrigeration equipment - May 2015](#)
- [WHO - Thermostability of vaccines](#)
- [WHO - User's handbook for vaccine cold rooms and freezer rooms](#)

## Information and Communication Technology (ICT)

### Common Terms in ICT

---

**ISP**

Short for "Internet Service Provider" - any company that provides internet to a user or agency.

---

**Propagation**

The method by which a radio signal is transmitted and interacts with the physical environment.

---

**Frequency**

The common measurement used in radio communications - measured by how close wavelengths of a radio wave are.

---

**LEO**

Short for "Low Earth Orbit" - when a satellite orbits close to the earth's surface.

---

**Geostationary**

An object in orbit of the earth that stays in a singular fixed location.

---

**NOC**

Short for "Network Operation Centre" - a central hub through which internet communication passes through, usually for linking remote connections with the rest of the global internet.

---

**Carrier**

A company that provides mobile voice communication.

---

**Omnidirectional**

An antenna does not have to be specifically pointed, and can send/receive signals from any orientation.

---

---

<b>Unidirectional</b>	An antenna that can only send and receive signals in one direction, and has to be pointed directly at the satellite.
<b>Radio</b>	Any analogue communications device that uses radio waves to transmit and receive signals.
<b>Repeater</b>	A device that amplifies and extends the range of a radio signal.
<b>GPS</b>	Short for "Global Positioning System" - a protocol for determining precise locations on the earth's surface using a network of satellites
<b>Latency</b>	Delay in time between a transmitted and received signal.
<b>VSAT</b>	Short for "Very Small Aperture Terminal" - a ground based satellite internet protocol.

---

## Tampere Convention

The Tampere Convention – short for The “Tampere Convention on the Provision of Telecommunication Resources for Disaster Mitigation and Relief Operations” – is a binding international convention that governs the use of radio and satellite communications in response to disasters. Among the provisions, the Tampere Convention requires states who are signatory to ensure “the installation and operation of reliable, flexible telecommunication resources to be used by humanitarian relief and assistance organisations.” In real terms, if an emergency has been declared in the country that has ratified the convention, and the country has accepted the assistance of the United Nations, then said nation cannot impede the use of telecommunications equipment in support of humanitarian assistance.

It should be noted legal obligations to provide free access to telecommunications only apply to member state who have fully ratified the convention. At the time of writing this guide, only 49 member states have fully ratified the Tampere Convention, with another 31 agreeing to ratify in the future. Many of the countries in which humanitarian organisations currently operate have not expressed any commitment to sign onto the convention, and even states who have ratified the convention may find specific reasons to impede or deny access to telecommunications services to humanitarian actors. Prior to importing communications equipment into a country, humanitarian agencies should consult with local authorities, customs brokers, and other humanitarians on the ground to understand what restrictions may be in place.

The full text of the Tampere convention can be found in [Spanish](#), [French](#), [English](#) and [Arabic](#).

## Computer Networking

The computer networking needs of an office or compound are very specific to the budgets, the size, the capacity, and the overall operational needs of the agency. Agencies should investigate hiring dedicated IT and networking staff to support setting up office and sub office networks.

## Office/Compound Set Up

In most field locations, there will be a mix of several very coming office network equipment. These items might include:

**Connection to External ISP** – Connection to an external Internet Service Provider (ISP) may come in the form of satellite internet, telephone line, or some other form of dedicated connection to a grid proved by the ISP.

**Modem** – Modems receive signals coming from ISPs and translate them into usable signals by home or office networks. Modems also contain user specific information which is used to identify, trace and monitor traffic for security and billing purposes. Without a modem, any home or office based networking equipment would be incapable of actually speaking to outside networks.

**Router** – A Router is a device that splits and manages internet traffic, enabling multiple computing devices to have their own unique IP and MAC addresses, and communicate with the internet and each other at the same time over a network. Routers have a variety of configurations and functions. Some can monitor and control traffic on the local network, and others have wifi capability. The type of router used will depend on the operational needs.

**Firewall** – A firewall is any device that specifically monitors and filters internet content coming from outside networks. Firewalls are useful for preventing malicious software, casual unauthorised intrusion into networks, or even block content not allowed by the IT policy of individual organisations. In simplified networks, firewalls are often merged with modems or routers, but advanced networks can have standalone firewalls that have different protocols for different users of the service.

**Switch** – A network switch is like an advanced form of a router – it controls and distributes the internet between multiple networked devices, however switches are capable of detailed monitoring and control down to the individual device level. Switches are also used to filter, block and secure internal networks similar to firewalls securing external threats.

**Server** – Servers are defined a computers that are fully dedicated to storing and sharing files within a network. Servers can be as simple as regular desktop computers, or as complex as large specialised computing devices that have special installation requirements. In recent years, many agencies have started using “offsite” servers, which host and manage files and data from locations outside of offices, sometimes from a different country. Offsite servers perfectly acceptable solutions, however if the users of the server have inconsistent connection to the internet, a localised server may be preferable.

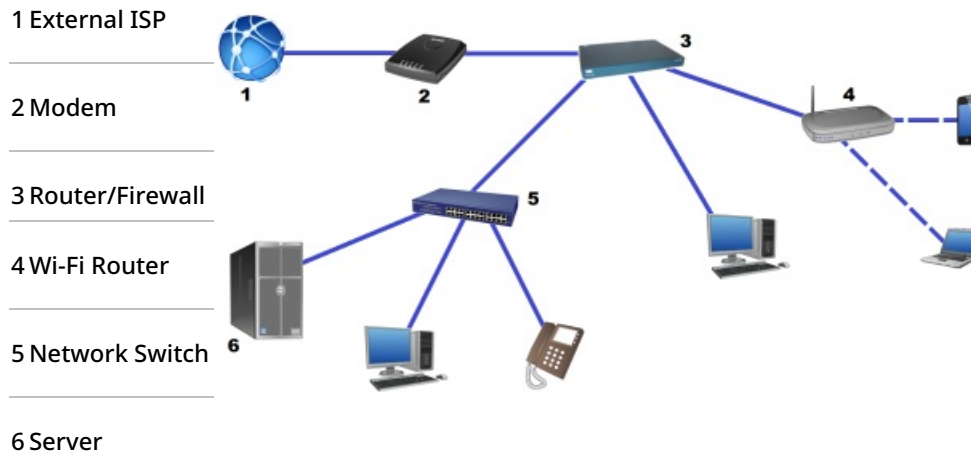

## Operational Security

The operational security requirements of each of local networks should follow basic rules.

**Access Control** – Only authorised persons should have access to networks and computing devices. All computers should be password protected, and wifi routers should also require a login credentials. Some networks allow for temporary guest access, however the needs for special settings vary depending on the operational environment.

**Malicious Software** – All computing devices on networks should have some form of anti-virus software, and operating systems should always be up to date. Agencies should consider installing firewalls and/or switches with managed settings to also cut back on the intrusion attempts or the transmission of malicious software.

**IT Policy** – Agencies should develop and share internal IT policies for all employees and users of the network. IT policies should include rules and regulations for what is considered acceptable behaviour, what the rules for using different types of hardware is, and establish guidelines for failure to comply.

## Wireless Communications

A large and increasing portion of communications technology is becoming wireless. As more and more processes become wireless, the more complex the infrastructure surrounding them becomes. Understanding the basics of wireless communication is becoming important for the average user.

## Electromagnetic Radiation

All forms of wireless communication rely on what is known as “electromagnetic radiation.” Electromagnetic radiation refers to waves of energy in the electromagnetic field, which carry – sometimes referred to as “propagate” – electromagnetic radiant energy across three dimensional space. Though the term “radiation” has negative connotations in common usage, used here it simply implies that a single point source is giving off – or “radiating” – energy. Electromagnetic radiation isn’t necessarily harmful to humans, however certain frequencies and in sufficient quantities it can be.

Observers perceive electromagnetic radiation in a variety of formats; both radio waves and

light waves are forms of electromagnetic radiation, they just happen to have different wavelengths and fall on different parts of the spectrum.

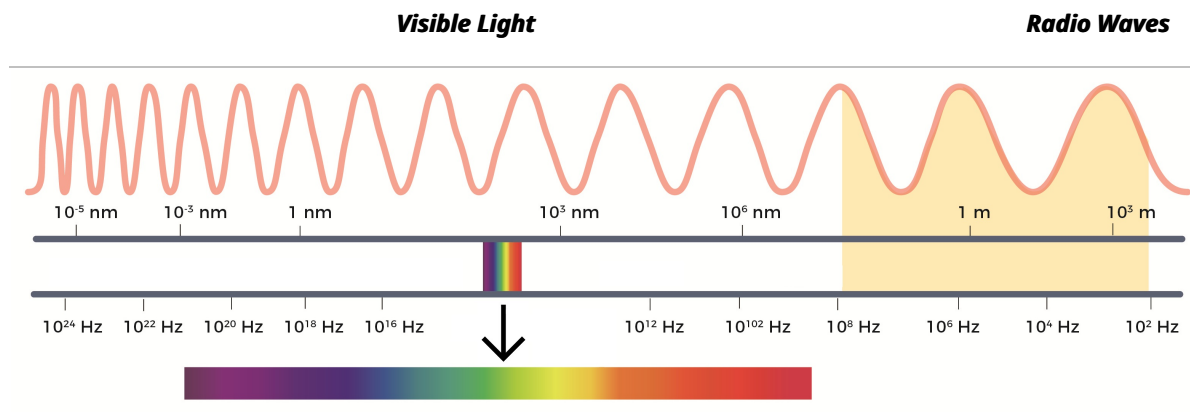

In a vacuum, all electromagnetic radiation travels at the same speed – the speed of light. As electromagnetic waves travel through different substances, their speed and/or ability to transmit begins to change based on the properties of the physical matter and the wavelength of the electromagnetic radiation itself. For example, both light and radio waves are able to pass through the earth's atmosphere, while only radio waves can pass through the walls of a building as light bounces off the solid structure. In any situation when electromagnetic radiation interacts with any form of matter, the radiation will always lose at least some of its strength as electromagnetic waves interact with molecules of the physical matter itself.

### Wavelength and Frequency

In electromagnetic radiation, there is a direct relationship between energy, wavelength and frequency. The shorter the wavelength, the shorter the period between the peaks of two waves. Because all electromagnetic radiation travels at the same speed, as the wavelength becomes shorter, the relative frequency of the wave increases, as the period between the peaks of two waves becomes shorter. As the frequency increases, more energy is conveyed over the same period of time, meaning shorter wavelengths with higher frequencies appear to be more energetic when received from a relative vantage point.

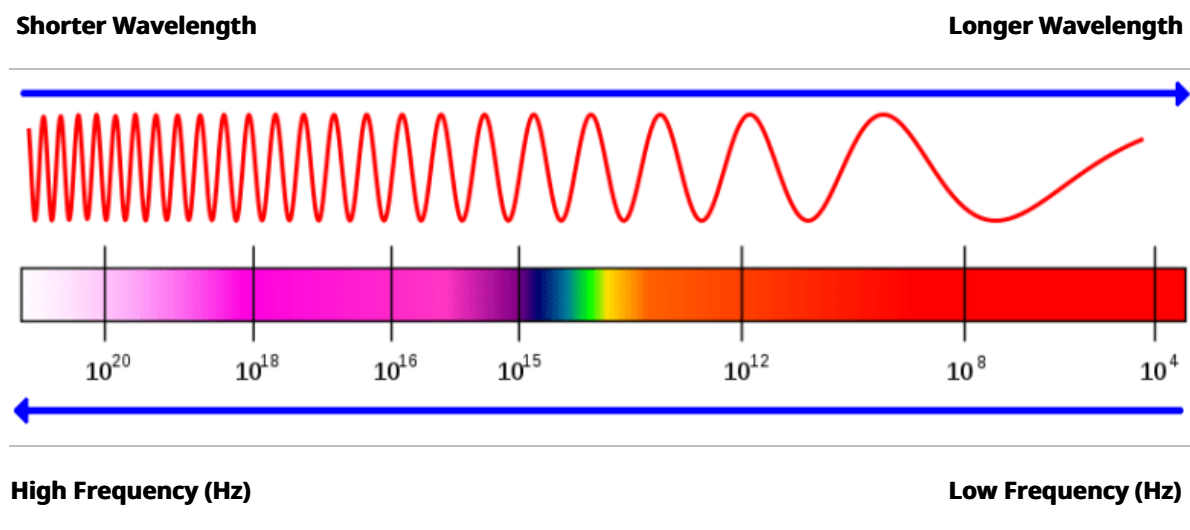

### Antenna Size/Structure

As there is a direct relationship between wavelength, wave frequency, and wave energy, there is also a direct correlation between wavelength and the size of the required antenna to transmit/receive a signal. Practically this means that the higher the frequency of a signal, the smaller the receiving antenna needs to be, the implications being that radio waves on the lower end of the frequency of transmission will require significantly larger antennas. For humanitarian agencies, there are real world trade-offs between the usefulness of a certain band of transmission, and how large their radio reception equipment can actually be.

## **Radio Propagation**

Propagation speed is defined as the length of time it takes for one thing to move to another. The speed of radio propagation in a vacuum is the speed of light, and this speed can be impacted by passing through a variety of transparent or semi-transparent mediums.

Additionally, as different wavelengths of electromagnetic radiation move through any transparent medium, there are subtle and very specific ways in which they are altered or interact with that medium which are governed by a variety of factors. When it comes to using radio or microwave signals within the earth's atmosphere, there are modes of propagation that impact communication.

**Line of Sight Propagation** – Line of sight propagation means radio signals can only successfully be received and transmitted if there is no large object blocking the path between the two. Line of sight propagation does not mean that both the transmitter and receiver need to be able to physically see each other – such as a satellite in orbit of the earth – nor does it mean that there has to be completely open space between two objects – such as a VHF radio working inside a structure with radio-transparent walls. Line of sight propagation is important because, hills, large structures, and even the curvature of the earth will limit how far a line of sight signal can go. Most VHF/UHF and microwave radio communications devices are limited by this method of propagation.

**Groundwave Propagation** – Radio waves can be propagated using what is called groundwave or “surface waves”. Groundwave propagation involves radio waves moving along the surface of the earth and bouncing off solid structures such as hills or buildings. VHF and UHF communications might benefit from groundwave propagation a little, but generally only higher frequency signals benefit from groundwave propagation.

**Skywave Propagation** – HF radio waves in the earth's atmosphere propagate using skywave or “skip” propagation. Skywave propagation enables signals transmitted along portions of the HF frequency to bounce off the earth's ionosphere and oscillate within the earth's atmosphere well beyond the horizon. Skywaves are able to reach around the curvature of the earth's surface, sometimes to great distances, however distances are impacted by a complex series of environmental factors.

In practice, all spectrum of radio waves interact with their environment in many different ways, meaning multiple forms of propagation may be possible.

- **Absorbed** – Radio waves are absorbed and neutralised by large stationary objects like buildings.
- **Refracted** – As radio waves pass through any medium of varying density, their course may be altered.
- **Reflection** – Radio waves bounce off stationary or solid objects, sending signals in a new direction.
- **Diffraction** – The tendency for radio waves to bend towards large objects as they pass over/around them objects.



The combined effects of these different effects creates what is known as multi-path propagation. Multi-path propagation practically results in signals being received in seemingly random or inconsistent ways. It is why signal strength can be increased or decreased by moving one or a few meters in one direction or another, and what may create dead-zones for radio communication.

## **Terrestrial Connections**

In a world with ever increasing technology, locally available and locally provided telephony and internet service is becoming more and more accessible. Locally provided service is referred to here as service provided by and to parties within countries of response, usually by local companies who may or may not operate in other countries.

## **Surveillance and Intervention**

Locally provided telephony and internet may end up being cheaper and faster than any other solution, and the use of local services is encouraged where safe and available. Humanitarian agencies operating in multiple contexts should always keep in mind that local voice and data providers always operate under the authorisation and limits of national authorities and regulations.

Many phone carriers and internet service providers are required to provide surveillance to governments about some or all users of their services. In some cases, telecommunications companies are partially or wholly owned by governments, and may be extensions of state intelligence or security apparatuses. In extreme cases, telephone and internet service may be shut off or denied to key persons, organisations, or all users of the service at once due to concerns over conflict, political unrest, or other security related matters.

Humanitarian agencies utilising locally provided voice or data services should always operate under the assumption that their activities may be surveyed or monitored at any time, and seek out redundant communications systems in case of internet or voice being shut off for whatever reason. Some governments heavily restrict the usage of outside or independent communications, such as radio or satellite communications, limiting options for redundant communications may vary from mission to mission.

## **Mobile Phones / Data**

Mobile phones and mobile provided data are quickly becoming ubiquitous throughout the world. While most people are becoming familiar with the regular use of mobile phones and data, there are a few things to keep aware of.

## **Wireless Carriers/Providers**

Wireless carriers and wireless providers are companies that interface directly with clients to provide wireless mobile service. The wireless carrier is often the same company that pays for the installation of a wireless network, however frequently providers rent or lease bandwidth from other company's cell phone towers to enhance their coverage.

A wireless carrier established in any given country will have close ties to regulators, working within the national laws and restrictions for provision of wireless communications. Due to the fact each country may have subtle differences in wireless regulation or usage based historical or financial reasons, the specifics of the service provided in each country may be slightly

different. Each wireless carrier in a country will broadcast on slightly different frequencies to ensure their individual signals have the least interference. Specific “instructions” telling the phone exactly which frequency to speak on come from the SIM card provided by the carrier.

### **Mobile Virtual Network Operator (MVNO)**

In recent years, there has been an increase in what are called Mobile Virtual Network Operators (MVNOs). MVNOs are mobile providers who don’t actually own or manage any of their own network infrastructure, and instead are essentially companies who’s service rests upon other service providers.

The MVNO model may seem counter intuitive – paying for a company who then pays another company seems like it should always be more expensive. The MVNO model has distinct advantages, however; MVNOs can buy service on multiple networks, including international networks, yet continue to provide one singular seamless service to users. MVNOs can also buy bandwidth and airtime in bulk from other larger carriers, and sell smaller portions to multiple parties who may not be willing or able to pay for traditional large service packages.

### **Wireless Protocols**

---

**Global System  
for Mobile  
Communications  
(GSM)**

The most widely adopted wireless communication protocol for mobile phones. GSM was developed by European Telecommunications Standards Institute as a method of dealing with standards across multiple countries in Europe, and has since become the default for most countries globally.

GSM is easiest to identify by the use of SIM cards.

---

**Code-division  
multiple access  
(CDMA)**

An older and less widely adopted wireless communications protocol, first established prior to the invention of the modern mobile phone. CDMA makes up less than 10% of global mobile communications.

CDMA phones don’t utilise SIM cards as a mode of linking the phone to the carrier, however many CDMA phones have SIM card slots for GSM usage as well. CDMA phones must be directly programmed to speak to the mobile carrier network, and often CDMA phones can only ever be used for one provider.

---

GSM has become the dominant standard globally. In the early days of commercial cell phone service, carriers would sell phones that would only work on their specific frequency, which helped drive costs down because phones only had to have one set of antenna. This would however lock phone usage to single networks and discouraged competition. Consumer advocacy groups and a rise in phones used in international markets prompted the sale of phones that work on all available frequencies available at the time of manufacturing. Modern cell phones can accommodate operating on a wide variety of carrier networks, and with the rise of large singular brands and globally popular phones also helps keep manufacturing standardised.

Even with phone capable of supporting multiple frequencies, carriers will still sometimes sell locked phones – meaning the phone is programmed to only operate within that specific carrier network. This is usually justified by the fact the carrier might have subsidised the cost of the phone to the consumer, and is recovering the cost through monthly service fees. The practice of locking phones is becoming widely discouraged, however it still occurs in many places.

In some contexts, using a single mobile carrier is not sufficient, and users may wish to use two

or more. Many mobile phones come with slots for two SIM cards, or may even have the ability to connect to both CDMA and GSM networks.

When acquiring mobile phones, humanitarian agencies should consider:

- Does this phone need to operate in a different country?
- Does this phone need to connect to more than one carrier?
- Will the phone need to be unlocked, or will it work natively with any network?
- Does this phone have the capacity to operate in the areas where it is needed?

## **Mobile Phone Generations**

The technology surrounding how mobile communications work are segregated into “generations” or referred to a “G” for short. This is frequently shortened even more to a number to help reduce confusion, such as 3G, 4G, 5G, etc...

There is no one specific technology that composes a “generation,” rather a generation is defined by a series of minimum standards, including voice communication encryption, data speeds and certain specifications for phone design. Each new generation of mobile communication is accompanied by new processors and new antenna technology which may not be compatible with previous generations. As such, as new mobile phone generations are introduced, older mobile devices will probably not work with new services.

## **Mobile Data**

Internet service from mobile carriers has become ubiquitous and almost more important than regular voice communication. The same limitations on hardware, wireless protocol, generations, carrier lock ins and general coverage still apply to data specific mobile applications. If humanitarian agencies are planning on acquiring mobile hot spots or dongles, they should consider all areas of operation equally as they would a mobile phone.

## **Landline**

Traditional landline communication is one of the oldest methods of electronic communication still in usage in humanitarian contexts. Landline voice communications are facilitated through physical infrastructure, usually telephone lines transmitting signals through large copper wires. Individual homes and offices are connected to the telephone network through a physical connection, usually requiring some form of professional installation from the telephone provider. Phones with dedicated phone numbers are called “dedicated lines.”

Wireless communications are quickly eclipsing the use of physical landlines, especially in humanitarian contexts where physical landline telephony might not have been available in the first place. Landlines are also susceptible to physical damage and may be harder to repair. Many agencies may wish to use landlines because they are probably cheaper, and offer specialised business support. The choice to go with a landline dedicated phone is up to each agency, however it is recommended to always have redundant systems of communication to avoid problems should one system be cut off.

## **Internet Service**

An Internet Service Provider (ISP) is any provider of internet in any format, however the term ISP is usually closely associated with internet provided by in-country terrestrial based companies. Traditionally, ISPs provided internet over telephone lines, however there is

currently a wide spectrum of different methods of providing internet to a fixed location, including phone, cable, fibre optic, and even point to point wireless. As mobile communications have become increasingly popular, the methods and nature of ISP provided internet service has started to blur with other forms of mobile communication.

The global internet infrastructure is extremely complicated and ever evolving. In the broadest terms possible, local ISPs serve as the bridge to services and content largely hosted outside of the country of operation. General concepts for internet service provision are:

**IP Address** - Every computing device connected to the internet has what is called an IP address, short for Internet Protocol Address.

**Web Servers** - Web services – such as websites and apps – are hosted on large “servers”, computers that store data and respond to incoming queries. Servers have IP addresses just like personal computers. Web hosting servers may or may not be in the same country as the person using the service hosted on the server. Many large companies have started hosting large numbers of services in one or a few locations globally.

**URLs** - The name of a website (example:[www.logcluster.org](http://www.logcluster.org)) are defined as Uniform Resource Locators (URLs). URLs are what most people commonly understand as web site addresses.

**DNS** - Specialised servers called Domain Name Servers (DNS) are what hold the key to translating what we know as URLs into the unique IP addresses of remote servers. DNS servers may or may not be controlled by ISPs in a specific country.

Local ISPs have incentives or disincentives to prioritise or block certain traffic. Many local laws prohibit certain types of content for cultural or political reasons. Additionally, weak local regulation may result in privately owned ISPs favouring some companies or services over others, purely out of collusion or anti-competitive practices. ISPs have the ability to filter or block websites fairly easily, especially if they manage their own DNS servers.

## Satellite Communications

The availability and access to satellite communications has been steadily growing for the past few decades, and while the number of providers and wide scale availability of land based or localised internet and voice providers has dramatically increased in the past decades, humanitarian agencies are still heavily reliant on satellite communications in a variety of contexts.

## Technical Considerations with Satellite Communications

### National Regulations

Even though satellite signals can theoretically be received in any location under the satellite's coverage area, there are still national rules and regulations governing the use satellite communications in different countries. Some countries may require special licenses and registrations for the use of satellite equipment, while other countries may ban them outright. Many governments have close ties with local telecommunications providers which enables them to monitor and control voice and internet traffic – satellite communications devices can and do circumvent many of these controls. Some states allow for the use of some satellite communications equipment, but require additional hardware be installed at a user's location to properly monitor activities.

Prior to buying, importing, using or selling any satellite communications equipment, humanitarian agencies should research and understand what the local regulations are. Failure to comply with regulations may result in severe penalties.

## **Latency**

The delay in time between when a signal or packet of information is sent and when it is received is known as “latency” in ICT terms. Latency is something that impacts all forms of electronic communication, however users of satellite communications are especially impacted by this. The inherent distances involved with satellite communication and the types of communications infrastructure in place to support satellite communications can lead to fairly high levels of latency between users. This is especially noticeable when communicating by voice over a satellite phone or VIOP connection – users will likely encounter some form of delayed feedback and must moderate their communication styles accordingly.

## **Antenna Focus**

Satellite communications devices can use both what are called “omnidirectional” and “unidirectional” antennas.

- **Omnidirectional** – Antenna does not have to be specifically pointed, and can send/receive signals from any orientation.
- **Unidirectional** – Antenna can only send and receive signals in one direction, and has to be pointed directly at the satellite. Unidirectional antennas tend to be used for stronger signals.

The antenna used by each device depends on the nature of the device, and it’s relationship to the satellite.

## **Spot Beams**

In the process of delivering communications to the ground, satellites use a variety of antennas to transmit and receive frequencies. In order to better control specific areas served by the satellites, or to compensate for potential equipment failures, many communications satellites utilise what are called “spot beams”.

When a spot beam set up is used, the satellite will break the signal up into many smaller geographic coverage areas. Often times, these spot beams directly correspond to physical hardware components, such as processors, individual antenna components or other stand alone features. In most cases, while special spot beams enable satellite communications providers to turn up or turn down the bandwidth available in specific spot beams, they also limit the maximum throughput per spot beam. In other words, the maximum data output capable of the entire satellite cannot necessarily be used in just one location.

**Example: Spot Beams**

**Real World Spotbeam Coverage - Inmarsat**

---

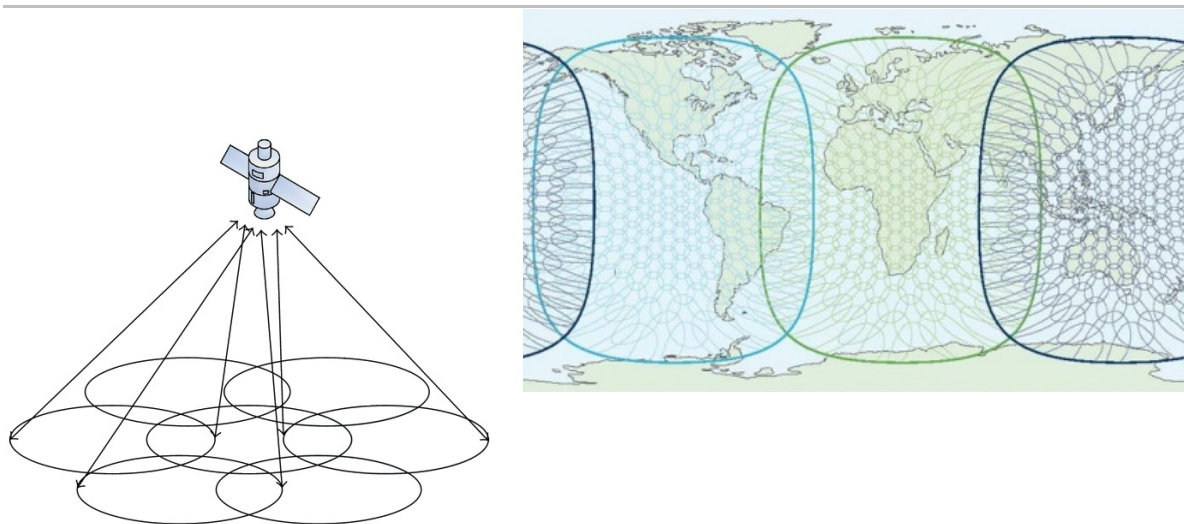

Understanding spotbeam coverage is important for humanitarian organisations utilising satellite communications. Often times, in post disasters or in complex emergency settings, many humanitarian agencies are co-located in the same clusters of towns and compounds. In situations where most or all actors are trying to access the same satellite communications service at the same time, they can overload the capacity of that specific spot beam. This is why even if only one or a few persons are using voice or data within your compound the system may still run slow – all of your neighbours may be doing the same thing at the same time.

### **Contention Ratio**

Contention ratio in normal networking terms refers to the ratio of the potential bandwidth capacity of a network compared to its actual network usage. In the world of satellite communications, contention ratio takes an entirely new context however. The contention ratio of a refers to the number of individual base stations that are using the same connection and the same channel at the same time. A ratio of 8:1 would indicate that eight total base stations are connecting to the satellite at once, and any organisation using a contract with a built on 8:1 ratio must be prepared to share bandwidth with seven other organisations at any given time.

In humanitarian response settings, the contention ratio of users can cause problems quickly. As many organisations pour into a disaster setting, often without any other functioning communications infrastructure, the number of concurrent organisations utilising a satellite communications network can add up quickly, especially for internet services. Many satellite communications providers can offer tailor made packages that guarantee lower contention ratios, however such packages tend to be more expensive. When planning to use a satellite communications device, plan ahead and know what it's intended use will be. Will this device be used for casual usage in areas where regular phone or internet coverage is spotty? Or will this device be used as the primary access point for multiple business essential users? If a data device is meant to be heavily used in emergency settings, perhaps a lower contention ratio package should be considered.

### **Network Operation Centre (NOC)**

In satellite communications, the term “Network Operation Centre” (NOC) is colloquially used to

refer to any location where a satellite routes terrestrial traffic through. When using a satellite phone or satellite internet, though the handset or base station may be speaking to the satellite directly, the satellite itself must still eventually route its traffic through another form of connectivity to complete the communication. Very few satellites offer direct communication point-to-point, while the vast majority of the time the other receiving end, either a computer, mobile phone hosted service is on a different network entirely.

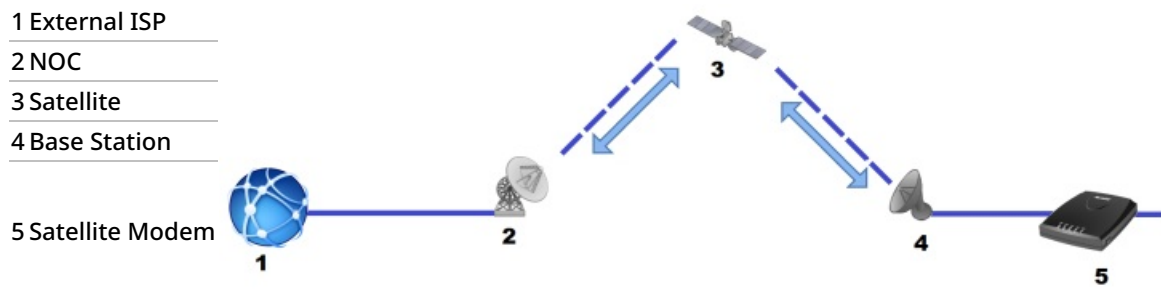

NOCs are the gateway rest of the world, and can route communications appropriately. NOCs are specially operated, and may be owned or sub-contracted by the satellite provider. In large satellite communications networks, a complex series of NOCs can be utilised to cover different geographic regions and special purposes. NOCs are also one many pieces of infrastructure required to enable satellite communications, but can also be another point along the communications chain that can slow down connections, and unfortunately service users have virtually no control over issues caused by NOCs.

## Bands of Transmission

Communications satellites operate using various form of radio and microwave transmission, both of which found on the spectrum of electromagnetic wavelengths. Communicating with satellites from the earth and vice versa requires wavelengths that can penetrate the atmosphere and deal with a wide range ambient interference. Additionally, satellite communications providers have settled on certain standards that comply with state and international regulations. When speaking about satellite communications, the most common bands of transmission are:

- L** 1.0 - 2.0 gigahertz (GHz), radio range
- C** 4.0 - 8.0 gigahertz (GHz), microwave range
- Ku** 12.0 - 18.0 gigahertz (GHz), microwave range
- Ka** 26.5 - 40.0 gigahertz (GHz), microwave range

## Understanding Orbits

Satellites by definition are above and outside the earth's atmosphere, and move along curved paths that circle the globe called orbits. Two objects in the vacuum of space will interact with each other, relative to their respective masses, their velocities, and the distances between them. In order to maintain a consistent orbit around the earth, satellites will need move along their orbital paths at different speeds depending on their orbital distance from the earth – moving too slow would result in the satellite crashing back into the earth's atmosphere, while moving too fast would result in the satellite breaking orbit and flying freely into space. In addition to variable speeds based on their distance from the earth, the further a satellite is from the earth, the longer it's circular orbital path.

The differences in speeds and the length a satellite has to travel in orbit, combined with the

fact the earth spins on its axis, result in extremely different experiences when satellites are viewed from a relative location on the earth's surface. If a single satellite is orbiting close to the earth, it may only be "viewable" for a short period of time from any given point on the earth's surface. If a single satellite is orbiting close to the earth along a predefined path that does not change – along the earth's equator for example – it may never be "viewable" from certain angles, such as from areas near the earth's poles.

Inversely, the further away from the earth a single satellite orbits, the wider the viewing angle it may have, meaning it may be more consistently reachable from any given point on the earth. However, the speed at which a satellite may orbit the earth at a further distance might dictate that the satellite may be unreachable for longer periods of time, or unreachable at all depending on the viewers location.

Understanding how satellites work is essential for humanitarian organisations that plan to use satellite communications as an integral part of their own operations.

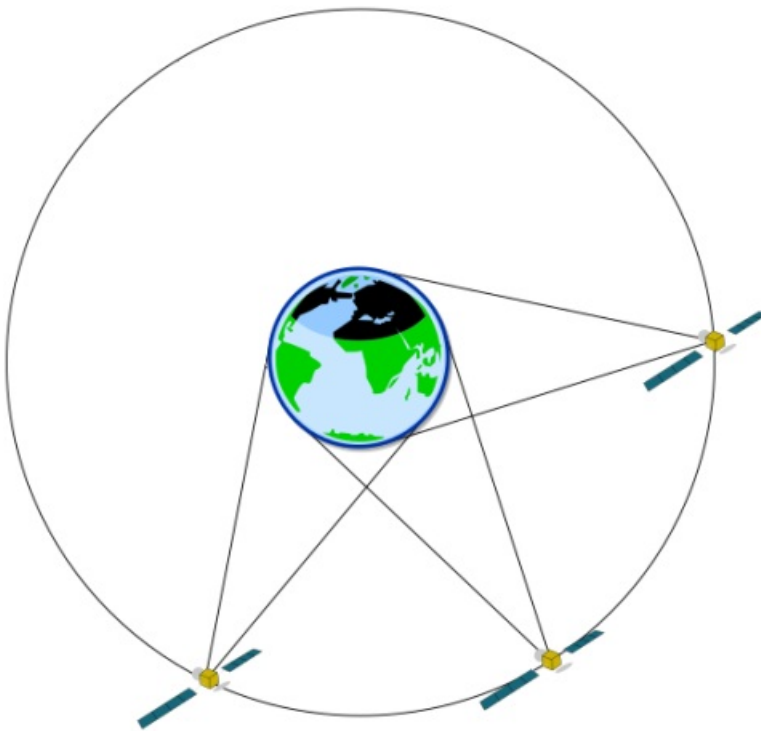

### **Geosynchronous/Geostationary Orbit**

When the time it takes for a satellite to complete one full orbit matches the time it takes for the earth to complete one full revolution on its axis, and when the satellite is orbiting directly above the equator and in the same direction as the earth's revolution, it is in what is known as a "geosynchronous" orbit. The practical result of a geosynchronous orbit is that when viewed from the earth's surface, the satellite appears to stay in the exact location above the earth's surface at all times, and can be called a "geostationary" satellite.

A geosynchronous satellite will always be at a fixed altitude of 35,786 km, and will be able to reach approximately 40% of the earth's surface in the area immediately under the satellite. At the closest distance there will always be a delay of at least 240 milliseconds, or 0.25 seconds between the time data/a message is sent, and when it is received on the other side. However, depending on the network arrangement, the speed of the physical hardware, and where the



transmitter/receiver are within that 40% coverage area, latency can be greater.

Satellites in geosynchronous orbit are useful for when there are only one or a few satellites required or used to provide a continuous service to a wide area. Due to the fact the satellites don't move relative to the viewer, communications devices accessing a geostationary satellite will need to be permanently installed and oriented, and cannot be moved or reoriented easily. This means that though the satellite receivers are not mobile, they also don't need to be compact, and can scale to be as large as required for the job.

Unfortunately, single satellites covering a large area means that singular geostationary satellites can and do service a high number of fixed base stations, and all users within the geographic area of coverage are reliant on a single source to transmit and manage their communications. This often leads to limited bandwidth availability, and can cause security problems – a single satellite poses a single point of failure. Additionally, geostationary satellites are easy for governments or militaries with the appropriate technology to block or jam, as the overall wavelength will remain constant and can be balanced out.

## **Low Earth Orbit**

Low Earth Orbit (LEO) satellite is a catch-all term used to describe any satellite that operates below an altitude of 2,000 km, while the term Very Low Earth Orbit (VLEO) is reserved for any satellite that orbits below an altitude of 450 km. There is no one defined path or distance of communications satellites that may inhabit the LEO range, and there are a wide variety of different providers and satellite configurations who make use of this system.

LEO satellites orbit relatively rapidly compared to the earth's rotation, and will make at minimum at least 11.25 orbits of the earth in a single day, with more being possible for lower LEO satellites with shorter orbital distances. Due to the fact LEO satellites are much closer to the earth, their field of "view" is much lower, and each LEO satellite can only cover a small percent of the earth's surface at one time. LEO satellites are also not constrained by the direction of their orbit; LEOs may orbit north to south along the poles, along the earth's equator, or in diagonal patterns that constantly shift their relative coverage areas.

If a communications device on the earth's surface were to only communicate with one LEO satellite, the satellite would be out of communication for large portions of the day. To remedy this problem, satellite communications providers will establish multiple satellites and have them communicate with each other in a satellite constellation or array. LEO satellites in an array will communicate with either directly, or through multiple NOCs on the ground. The number and approximate coverage area of LEO satellites in an array is extremely variable, and can range from a small number for specific applications to potential arrays of hundreds of satellites serving a single purpose.

LEO satellites offer advantages, in that the increased number of functional communications satellites can dramatically increase the availability of useable bandwidth. LEO satellite arrays also offer some security benefits – if a single satellite has technical problems it likely won't impact the other satellites in the constellation. LEO satellites are also much harder to radar jam, as their movement makes signal interference more technically challenging.

Unfortunately, LEO satellites also lead to significantly higher start-up and usage costs because sending multiple satellites into orbit and maintaining them adds more cost to the process. Also, due to the fact LEO satellites have narrower fields of view, a consistent signal may be harder to maintain in some operational environments.

There has been a recent increase in the number of LEO and VLEO providers as commercial

space cargo becomes more financially viable, and the hardware to make communications satellites becomes smaller and cheaper.

## **Very Small Aperture Terminal (VSAT)**

VSAT satellite internet is probably one of the most established and widely used forms of satellite communication by humanitarian agencies. VSAT – short for “Very Small Aperture Terminal” – technology was developed in the 1960s, and became widely commercially available starting in the 1980s. Though prohibitively expensive in the beginning, today VSAT providers can be easily found in most countries where VSAT communications are allowed by local laws. VSATs are distinctive by their large, unidirectional satellite dishes.

VSATs work exclusively off of geostationary satellites. A variety of companies have launched multiple VSAT specific geostationary satellites in the past few decades, usually positioned above regions of the world where they believe most customers are or will be located. Though there are some universal parts to VSAT equipment, it should be noted that VSAT installations cannot switch between different satellites without obtaining new hardware, repositioning the dish, and likely entering into a commercial contract with a different service providing company. VSATs largely use the C, Ku and Ka band spectrum, and communications providers will even use specific frequencies within those bands. For this reason, specific components for VSAT provider likely cannot be used for a different provider.

VSAT connections are usually billed on a monthly basis just like a regular terrestrial based internet provider, however special arrangements can be made for usage only certain times of the day/week, or to only be used during emergency settings. The monthly cost for VSAT provided internet varies dramatically, depends on the data plan, usage, the number of VSATs governed under one contract, and the general geographic location, but can easily cost upwards of 1,000 dollars a month for a basic connection. Download speeds also vary, and depend on the hardware and the terms of the contract.

The internet service provided by VSATs, while expensive, is still largely one of the cheaper satellite internet connections available. Additionally, VSAT internet is usually capable of and suitable for supporting multiple connected computers and IP enabled devices concurrently. While upload and download speeds will never be equal to most terrestrial based connections, VSATs are still largely considered the preferred satellite option for business settings, or guesthouses where multiple persons will live and work.



Though the term “very small” would imply VSATs are little, they are actually currently one of the largest satellite communications terminals commercially used. The satellite dishes used in VSAT installations can be very heavy and measure up to 1.5 meters in length, or even more, and require a firm anchor.

### **Fixed VSAT Installations**

In fixed installations, the dishes themselves are usually firmly attached to a standalone metal pole, which is sunk into the ground with concrete or anchored to a building. Fixed installation dishes installed at a specific location are specifically designed to match both the GHz transition frequency of the connecting satellite and the geographic location of the base station, and need to be carefully aligned and calibrated to work with the selected ISP. Installation of VSATs should only be conducted by professionals, usually working on behalf of the ISP.

### **Mobile VSATs**

Recently, many emergency responders have moved towards more advanced mobile VSAT technology. While other mobile ground terminal technology exists, what is important about mobile VSATs is that their underlying technology is the same as regular VSATs: relatively large, specially made dishes that work off geostationary satellites. Mobile VSAT equipment must be purpose made with the mobile application in mind, including:

- Dishes that can be collapsed or taken part.
- Possibly multiple BUCs or Modems.
- Adjustable dish mount.

Some mobile VSATs are capable of automatically detecting the appropriate satellite and aligning themselves, and are referred to as “self-acquiring” VSATs. Other mobile VSATs require manual configuration every time. Mobile VSATs tend to be very expensive, and require

specialised training to handle and set up. Before attempting to buy a mobile VSAT, an organisation should understand its intended end use. A mobile VSAT should never be used in place of a permanent VSAT wherever possible.

## VSAT Components

Unlike other self-contained mobile ground terminals, VSATs are made of multiple pieces of specialised equipment that must be specified for the application.

1. Satellite Dish (also called a "reflector") – a parabolic dish of non-radio transparent material that reflects information going to and from the satellite to the focus of dish.
2. Block up Converter (BUC) – BUC units convert low energy signals to high energy signals, and are used to "send" the signal from the VSAT
3. Low Noise Block Converters (LNB) – LNBs convert high energy signals to low energy signals, and are used to convert data received from the satellite into a usable signal for the modem.
4. Modem – proprietary hardware that translates the signal from the satellite into usable data for a computer or computer network.



BUC, LNB and modems all require some form of external power, though usually relatively low. If a base or office will be without power for multiple times of the day or week, it will have to consider a battery back up for the VSAT if satellite provided internet is required at all times. Additionally, BUC and LNB units are outside and easily accessible. Though they are relatively low powered, users should avoid touching them or coming into contact with them while power is supplied. If necessary, the dish can be marked with a warning sign, or even be fenced off in a secure location.

## Common Problems with VSATs

Though VSATs are fairly well established and well used, they are not without their problems

and users can and do make common mistakes.

**Bad Weather** The bands used by VSATs – C and Ku – can be adversely impacted by bad weather, including heavy rain, thunderstorms, sandstorms and even thick fog. Any tiny particles suspended in the atmosphere can and will impact the radio signals coming to and from a satellite.

---

Satellite dishes used for VSATs should have a direct line of sight to sky to properly function. Buildings and structures, trees, hills, vehicles and even people can block signals if placed in front of satellite dishes.

**Blocked Signals** When installing a satellite dish, users should plan for activities that might occur around the dish, or future changes that might impact the installation. Trees may eventually grow to block a signal, and the tree will either need to be pruned or the dish moved. Sometimes parked vehicles or stored materials can block dishes un-intentionally. Also, do to the mostly permanent nature of the dishes, users may simply forget how they work – building a new structure or raising a compound wall may block the signal.

If users are experiencing problems with VSAT signals in good weather, they should investigate if something is blocking the signal first.

---

**Low Power** VSATs equipment still requires power to receive, transmit and interpret signals from space. Sometimes, under-powered equipment may still appear to be working but not actually able to perform well. Low powered or under-powered equipment may come from a poorly maintained generator or power grid.

---

## Mobile Voice and Data Satellite Systems

There has been an increase in the number of and availability of mobile voice and data devices that work off communications satellites. These devices usually run off proprietary satellite arrays that have their own configurations, shortcomings and special considerations. Many companies that started offering only one type of voice or data solutions have begun offering a spectrum of products for both voice and internet utilising their own satellite networks. For this reason, it makes sense to speak about them by provider instead of by service type.

### Iridium

The Iridium satellite constellation is one of the earliest entrants into the mobile satellite communications services market, going online in 1998 and providing continuous service since. Today, Iridium is widely used by military, commercial companies, and humanitarians alike.

The Iridium network is comprised of 66 LEO satellites that orbit the earth from pole to pole, and utilise the L Band for uplink and downlink.

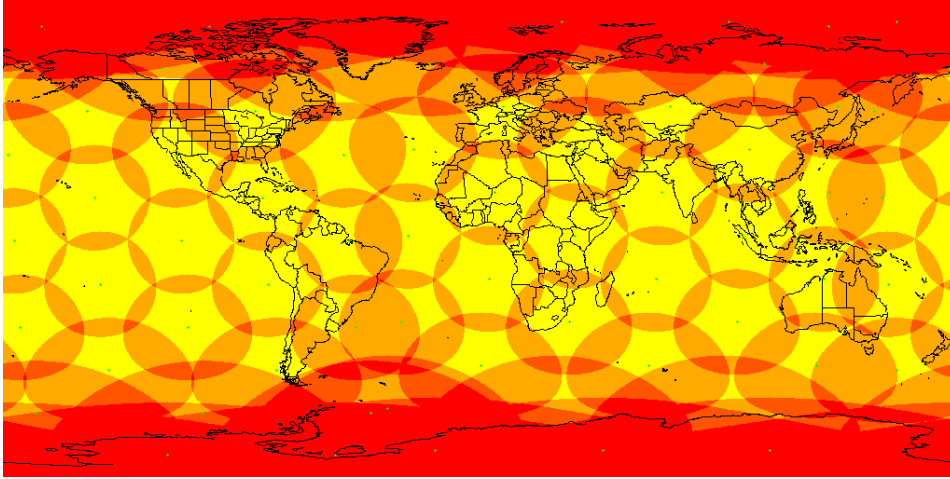

### *Iridium Coverage Map*

Originally, Iridium provided voice only service, using large handsets that communicated with the overhead satellites, however Iridium now offers limited data service for internet connection. The basic idea behind the network isn't dissimilar to modern cell phone towers; there is a signal "hand-off" between satellites, meaning users on the ground may not notice when one satellite moves past the horizon and phone connects to another satellite.

The benefits of the Iridium network are that its coverage is global, and will realistically work on any place on the earth's surface. Iridium is beneficial for agencies that may send users to any or multiple locations on the planet, especially in unplanned emergencies. Its global coverage has made it very attractive to some industries, such as aviation and maritime. In practice, Iridium phones face the same challenges that any LEO satellites face – the fact the satellites are in constant motion means that they will inevitably move towards positions of less coverage. If a user is in an urban environment, a forest, or surrounded by mountains or canyon walls, signal strength may be intermittent.

Iridium devices connect via unidirectional antennas, and come in a variety of form factors. Though Iridium devices do provide data services, it is usually limited to below one megabyte per second download. The majority of the commercial Iridium devices used in the humanitarian sector are self-contained, meaning they only need a battery charge or connection to a power source to work, however there are a variety of accessories to augment usage.

## Example Iridium Handset Phone

---



---

**Thuraya**

The Thuraya network, like Iridium, started offering consumer grade satellite voice services and has become a widely used and trusted network. Thuraya first began services in 2003, and currently uses two geostationary satellites to provide voice and data services to ground users.

Due to the geosynchronous nature of the satellites, the Thuraya network only serves a fixed number of geographic locations on the earth, predominantly in Europe, Africa, the middle east, South and Central Asia, and Oceania.



*Coverage Map. Source: Thuraya*

Thuraya voice devices work off the L band spectrum, and use omni-directional antennas to connect. The use of only two geosynchronous satellites drives down operating costs, however limitations include increased latency, increased interference, and the potential for more environmental interference. Additionally, Thuraya unfortunately cannot service anywhere in the Americas, or any location too far north or too far south in any of the hemispheres.

Thuraya also offers internet service through a proprietary terminals. The Thuraya internet terminals are unidirectional, and require physical orientation to connect to one of the two satellites, however there are self-pointing models available at higher costs, and depending on the needs of the user. Thuraya ground terminals can easily reach speeds of to 400 kilobytes per second.



### Thuraya IP Mobile Internet Terminal



### Thuraya Handset Phone



---

### Inmarsat/BGAN

Inmarsat began its life as a non-profit organisation in support of maritime vessels, but was privatised in 1998. Inmarsat began offering global satellite internet data starting in 2008 through what is called the Broad Global Area Network (BGAN). The BGAN network runs off on three geosynchronous satellites strategically positioned to cover most areas of sea and landmass used by human settlements and activity.

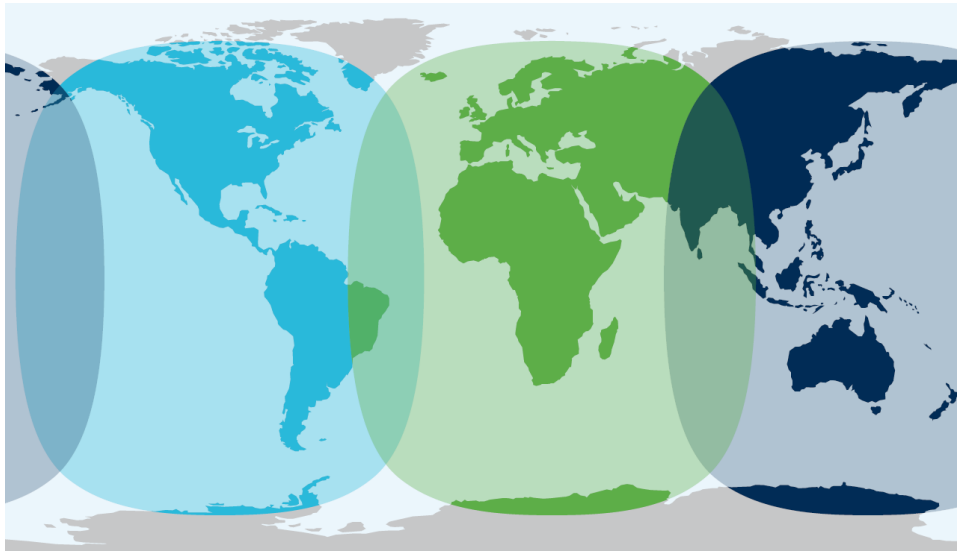

*Coverage Map. Source: Inmarsat*

Inmarsat offers a wide range of BGAN terminals that are designed for different levels of throughput and usage. All BGAN terminals are unidirectional, run on the L band, and require orientation by the user, however various models include self-pointing models for use on moving vehicles. Depending on the type of terminal, BGAN speeds can reach 800kbps, and some BGAN terminals can even be linked together to produce speeds of over one megabyte per second. Because all Inmarsat satellites are geostationary, the same usual limitations apply.

Beginning in the early 2010s, Inmarsat also began offering standalone voice service as well. Dedicated voice plans run off standalone handset phones that use omnidirectional antennas, and work in all places BGAN service is provided.

#### **BGAN Terminals**



#### **Roof Mounted Self Acquiring BGAN**



### **Starlink**

One of the newer companies to offer high bandwidth satellite internet is Starlink. Starlink began launching satellites in in 2018, and now has over 6,000 satellites in orbit, with more planned in the near future. Starlink satellites provide coverage for the entire planet, however local regulations may limit this.

The Starlink satellite constellation takes a different approach than previous satellite internet providers – Starlink has launched satellites in various orbital paths in LEO and VLEO orbital planes. The LEO/VLEO satellites have very short orbital periods, circling the earth multiple times

a day. The satellites all actively transmit data between each other, forming a virtual “net” around the world. This means Starlink satellites both actively transmit data to ground stations (NOCs) but also between each other, speeding up data transmitted around the globe.

Individual Starlink satellites are not designed to have long service lives, and their orbits are designed to decay after several years. The act of replacing the satellites allows the company to replace older models with upgraded hardware, and increase its network offerings.

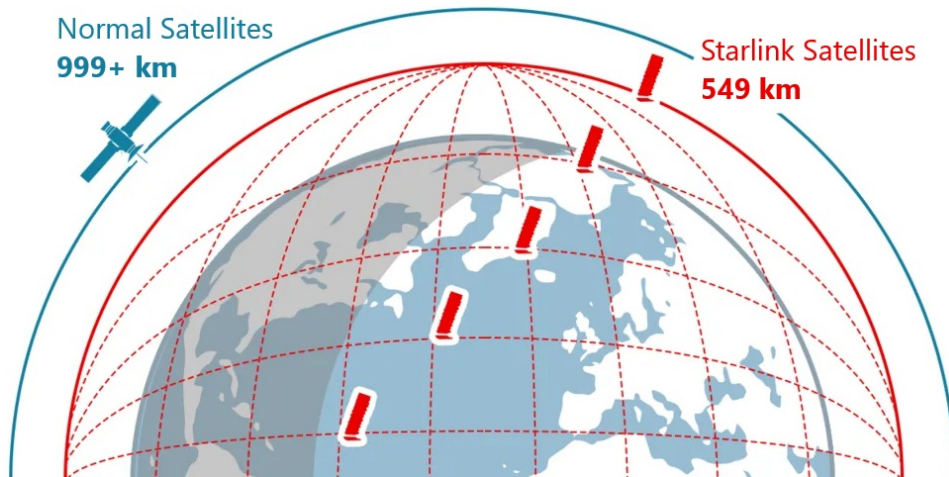

Starlink ground antennas are designed to be omni-directional, and don't require special orientation, however they will still require clear, unimpeded access to the sky. Nearby obstructions such as buildings or tall trees will still disrupt service. As the satellites rapidly orbit the earth, the antenna will automatically register and connect to satellites rising on the horizon. New antenna models are continually being produced.

Example Starlink antenna:



Other advantages of Starlink as a service include:

- The high number of satellites create critical redundancy, reducing the strain on any one orbital satellite, as well as compensate for any one satellite that may be experiencing problems.

- The network has extremely high bandwidth compared to most other satellite providers.
- The network will slowly evolve, enabling enhancements to internet speeds and newer hardware to be used.

Some disadvantages of Starlink as a service might include:

- The ground antennas and modems require comparably larger amounts of energy to maintain a constant connection.
- Many governments heavily restrict or block access to Starlink.
- As the satellite network slowly upgrades, older antennas and equipment may no longer function.

Consult with a professional supplier on hardware and ground installation needs before making a purchase of Starlink internet services.

## **Additional Providers**

There are a number of additional providers of satellite communications that have either entered the market in the past few years, or will be entering the market in the very near future. Advances in technology and new investments will substantially increase not only coverage, but overall data speeds, while keeping costs at a manageable rate. It is very likely that in the next decade there will be a substantial increase in the number of commercial providers that humanitarian agencies will be able to use.

## **General Guidance on Mobile Satellite Device Management**

### **Operating Costs**

The operating costs associated with current mobile satellite devices can be extremely prohibitive for many agencies. The physical devices themselves can range from hundreds to thousands of dollars, while the voice and data rates can cost vastly more than regular terrestrial based providers, especially for mobile satellite internet. Any individual or agency who plans to own and operate a mobile satellite communications device should investigate plans up front, and know what costs are going to be incurred.

Any personnel using satellite devices should be educated on their proper use and what costs are associated with each one. As our working environment becomes more and more dependent on connectivity, casual users may not be aware of all of the background data a single connected computer may use, including downloading system updates, emails, or corporate file sharing programs. Unless users are on some form of unlimited plan, all unnecessary data usage should be restricted, and no unauthorised access to the satellite terminals should be allowed! A single mobile satellite data terminal may end up costing tens of thousands of dollars in a single month if used like a regular connection, a problem that is compounded if more than one terminal is in use by an agency.

### **Hazards**

Some satellite communications equipment, especially unidirectional satellite data terminals, can emit harmful amounts of radio and microwaves when in use. Users should clearly read the instruction manuals and pay attention to any hazard or warning stickers or labels. Users should never stand within 1 meter of the front of a unidirectional ground terminal, and ideally terminals should be placed at higher elevation to avoid risk of mismanagement.

### **Radio Transparency**

A common mistake many users make is trying to use the satellite connected device indoors, under structures or generally obscured by physical objects. Many casual users are used to mobile devices such as phones that will work in most areas, and may not instinctively understand the need to have a clear line of sight to the sky, especially for users of sat phones. Generally, satellite connected devices will not work under roofed buildings, or any other solid structure that is not sufficiently "radio transparent" – meaning radio waves cannot easily pass through them. Material such as concrete, sandbags, metal rebar, and other common building components can interfere with and block radio waves all together. Satellite connected devices might be able to work under some materials, such as tent material or plastic tarpaulin, however users will need to be aware that this still may not work in all cases.

### **Extensions/Masts**

Mobile satellite communications providers offer a wide range of accessories that assist and enable the usage of the phones and data terminals. These might include:

- **Extension cables** – to mount some devices on roofs or above tree lines.
- **External antennas** – to increase signal and broadcast strength.
- **Docking stations** – to permanently power or mount some devices like sat phones.
- **Self-orienting options** – devices that can auto detect and point data terminals while in motion.

Depending on the needs of a humanitarian operation, users should consider all options where required, and speak with providers to better understand what may be available or feasible.

### **Calling Codes**

Due to the fact satellites provide telephony is never actually tied to a specific country, satellite communications providers have been provided their own "country code." Calling a satellite phone from an outside network required dialling the full country code prior to the satellite phone number. The calling codes for each provider are:

**Iridium/Thuraya: +882 16**

**Satellite Country Calling Codes** \_\_\_\_\_

**Inmarsat: +8708**

Additionally, calling from a satellite phone to a terrestrial based network requires dialling the full country code to reach the intended number, even if users are in the same country as the number being called.

### **SIM Cards and Devices**

The vast majority of mobile satellite solutions work off the use of SIM cards, just like GSM mobile phones, while communications hardware have serial numbers and other identifying codes. When obtaining new satellite communications devices and plans, users should record SIM numbers and International Mobile Equipment Identity (IMEI) numbers of hardware devices. Both SIM cards and IMEI numbers should be tracked, and ideally audited periodically.

In emergencies, devices can be lost, stolen, or simply forgotten about. Users should take care not to misplace SIM cards, as the liability and costs associated with the service are tied to the card and not the device itself. If a SIM card is lost, it can be misused by other knowledgeable persons, possibly for criminal or violent activities. Users should be instructed to report loss or theft of satellite communications equipment as soon as they are able, and if a device is lost or

cannot be accounted for, the service connected to the SIM card should be deactivated immediately to prevent misuse.

### Resellers/Providers

The majority of satellite communications devices and plans are sold through resellers – other companies specialised in local laws and local markets. Different resellers can negotiate with the primary networks to offer a variety of different plans to end users. These plans may include:

- **Pay as you go** – plans that only bill as they are used – especially useful for emergency responders.
- **Monthly** – payment for all devices made monthly, with either fixed rates or flat fees.
- **Pre-paid** – plans with predefined limits that will only work up until the dollar value paid in advance.

There are also a variety of custom payments and plans that can be available to requesting agencies. As an example, humanitarian agencies that have a high number of active devices may choose to enter global plans that cover all active devices in a single bundle. Additionally, speed or bandwidth can be throttled in some parts of the world during periods of low usage (night time) to allocate to other areas of high usage (daytime) at the same moment. Any humanitarian agency seeking satellite communications devices should speak with multiple suppliers and obtain multiple quotes.

### Common Problems with Mobile Satellite Devices

<b>Signal is Weak or Broken</b>	<ul style="list-style-type: none"><li>• Is the device being used indoors, or obscured from a direct line of sight to the sky?</li><li>• Is there some other transmitting device or frequency that may be interfering with the device signal?</li></ul>
<b>Device Won't Connect to Satellite</b>	<ul style="list-style-type: none"><li>• Does the device have a SIM card in it?</li><li>• Is the device SIM card Active?</li><li>• Is the device being used indoors or around tall structures, hills or trees?</li><li>• For unidirectional satellite antennas, are they pointed in the correct direction?</li></ul>
<b>The Device Is Connected But no Service is Provided</b>	<ul style="list-style-type: none"><li>• Has the service connected to the SIM card been activated?</li><li>• Has the service connected to the SIM card been paid for, or is the SIM connected to a post-paid account?</li><li>• Has the service connected to the SIM card been suspended or terminated for any reason?</li></ul>

### Radio Communications

The use of mobile radio communications has a long standing history within the humanitarian response community, and is still widely used today. There are currently a wide variety of mobile communications devices available to humanitarian responders, however not too long ago radio communication was basically the only way to maintain continuous communication with a distributed network of humanitarian actors.

As radio networks are essentially completely self-maintained by humanitarian agencies, they

are still in real terms the fail-safe within a communications network; state or military actors may shut off or disable commercial communications networks, but radios will work as long as the humanitarian agency keeps their radio networks active and well maintained.

## Technical Concerns with Radio Communications

### National Regulations

The use of radio communications to support humanitarian operations is generally considered an acceptable and legal practice in most countries of operation, however there are a few countries where radio communication may be banned or heavily constrained. Even if the use of radio communications is considered legal, there will almost certainly be a national registration process where owners and operators of radio networks will need to apply for and obtain licenses for lawful use.

The predominant reason that national authorities may wish to track and regulate radio communications is to protect the usefulness and functionality of already used radio frequencies, while deconflicting future use of frequencies. In most countries where humanitarians operate, some form of radio communications is already in use by national and state actors, including police, military, and emergency first responders.

To manage this process, national authorities usually have a pre-allocated frequency range that non state actors such as humanitarian organisations can communicate using. As part of a registration and licensing process, national or local authorities may also allocate specific frequencies to each requesting organisation, so any activities associated with that frequency can be linked directly to the licensed body. Any humanitarian agency granted a specific license will be expected and obligated to utilise the frequencies provided, and will either need to program their own radios or find a means to have those radios programmed.

### Constraints of Radio Communications

**Distances** – Depending on the type of radio, the size of the antenna and the energy source behind the radio, radios may only be able to communicate up to a few kilometres. In urban environments or places with dense vegetation, hills or canyons, this distance may be even less. Agencies or personnel utilising radio communications should have an understanding of the capabilities of the devices they are utilising, and ideally the IT, security and logistics personnel of a humanitarian organisation should have a sense of what geographic areas might be supported by the type of equipment in use.

**Dead Spots** – Even in areas of overlapping radio coverage, there may still be dead spots, brought on by structures, hills, vehicles, or other materials that might block radio signals. When conducting operations, personnel should be aware of that dead spots may occur, and may need to periodically conduct a radio check to determine if radio is still usable in a specific stationary location.

**Interference** – Radio signals can and will interact with other electronic equipment. Household appliances such as microwave ovens or other equipment using radio waves such as traditional broadcast TV might impact or impair radio operation. Objects with large electrical charges also produce electromagnetic fields that might impact radios as well – telephone power lines, large transformer boxes, and even large generators may affect a signal. Avoid installing or using radio equipment under or near power lines or radio towers used by other companies or agencies.

## Components

### Mobile Radio Unit

**Mobile Radio/handset units "transceivers"** – radio equipment that can both send and receive a signal. Some radio units are completely self-contained and come with batteries to power the device for several hours or a full day, while others require external power sources, like those mounted to vehicles. Additionally radios can be defined as mobile – radios that travel around with persons or vehicles, or as stationary – radios that are permanently connected to a ground station.

#### Handheld Radio

#### Vehicle Mounted Radio



---

**Point to Point** – when a radio units communicate with each other directly without a base station or a repeater between them, they are conducting point to point communication. Depending on the type of radio and the frequency used, point to point communication may be very limited. Most handheld radios that run off of batteries don't have the energy output or large enough antennas to push signals very far, and will be limited to hundreds of meters of point to point communication.

**Networked/Relayed Communication** – When two radio units communicate using at least one intermediary device, such as a base station, that communication is not point to point, and can be called a networked or relayed connection.

#### Antenna



Antennas are what physically enables the radio to capture radio waves and conduct the signal into the unit. The shape, size and overall construction of the antenna is determined by the type of radio, including the width, length, orientation and composition materials. Antennas are essential for the communication process, and users should be wary of damage or obstruction to antennas to avoid communication lapses.

Common Antenna Terms:

- **Antenna Gain** - The factor by which input power to the antenna will be multiplied to provide higher output power. Higher output power results in greater broadcast distance and signal strength.
- **Antenna Bandwidth** - The range of frequencies over which antenna operates satisfactorily. The difference between highest and lowest frequency points is referred as antenna bandwidth.
- **Antenna Efficiency** - The ratio of power radiated or power dissipated in the antenna structure to the power input to the antenna. Higher antenna efficiency means more power is radiated into three dimensional space and less is lost within antenna.
- **Antenna Wavelength** - If wavelength is the distance a radio frequency wave travels during one cycle period, the antenna wavelength is the size of the antenna based on the wavelength. The longer the wavelength, the longer the antenna.
- **Antenna Directivity** - It is the ability of the antenna to focus EM waves in particular direction for transmission and reception.

## **Base Station**

Radio base stations are also transceivers, usually installed in a fixed location in an office or living compound. The fundamental programming and etiquette of a radio base station isn't different than mobile radio units, however base stations can have significantly larger antenna arrays, and can supply greater power from the grid or generator to boost the signal to much further distances than mobile radios. The antenna arrays of base stations usually are more complex than mobile or hand held radios, often with two separate antenna structures separated by up to a meter or more – one antenna to receive incoming signals and another to broadcast outgoing signals, segregated so multiple communications do not interfere with each other.

Base station radios can also be configured to function as repeaters – taking a signal coming from one mobile radio unit, and amplifying it/rebroadcasting it so that it can reach a much further distance. Occasionally, specialised radio base stations are designed to accommodate multiple types of radio configurations at once, HF/VHF/UHF and others. These types of multi modal communications base units are highly specialised and typically used by agencies with professional radio and communications experts.

## Example of a Base Station

---



---

## Repeaters/Repeater Networks

Radio Repeaters are devices that can receive a radio signal, and rebroadcast it while at the same time amplifying its signal. In terms of voice communication, this means that a mobile handheld radio working off a radio repeater will be able to stay in continuous communication over longer distances. If two or more mobile radios are working off the same radio repeater, and are programmed to the same channel and frequency, they will be able to maintain direct communication while being far outside of point to point communication range. The requirements for a repeater are similar to a base station, in that a large external antenna array with multiple antennas and an external power source will be required to provide continued communications.

In some instances, governments or agencies may install what is called repeater network – more than one repeater arranged a pre-determined network that can continually share voice and data signals between them. A well-established repeater network can cover a wide area of terrain, however it will also require maintenance. If a repeater is installed in an insecure location, or in a location with intermittent access to power it will no longer serve its core function and may not be worth the effort or cost.

## Simplex vs Duplex

The concepts of simplex and duplex apply to any form of communication, however they are

especially important for radio communications.

### **Simplex**

Simplex communication is best described as “one way” radio – a configuration in which voice or data can only be broadcast in one direction. The basic example of a simplex network is a traditional TV or music radio broadcast signal; a primary source broadcasts a signal and a receiver with the appropriate hardware can pick up the reception.

### **Duplex**

Duplex communication is best described as “two way” radio – both ends of the radio transmission can send and receive a signal. Radios used by humanitarian agencies for coordination and security would only really make sense utilising duplex communication, and the vast majority of radio communications equipment available on the market is built around duplex communication.

The concept of duplex communication is an oversimplification of how most mobile radios work, however. A true duplex configuration requires two more independent antennas, each broadcasting on a slightly different frequency so that signals can be broadcast and received simultaneously. Simultaneous broadcasts would in effect allow users to both talk and hear voice commands at the same time, not too dissimilar to modern phones.

Most mobile radios however frequently do not possess the ability to both send and receive a signal at the same time. There are multiple reasons for this, but fundamentally duplex mobile radios would be bulky and expensive and the trade-off includes using what is sometimes referred to as **half duplex**. In half duplex, a single antenna is used to both send and receive a signal, and users utilise “push to talk” communication. When the user of a mobile radio unit is depressing the talk button, they cannot hear incoming signal, and vice versa. Though a base station may be able to manage and interpret multiple signals, users in the field on a mobile unit will not. It is important that users understand this – if they depress the button continuously they may miss important messages.

### **Operating Security**

There are a variety of security constraints pertaining directly to radio usage in humanitarian contexts. Radios are widely available and used throughout the world, and humanitarian actors may be utilising radios alongside police, military and non-state armed actors.

### **Unencrypted Signals**

The majority of radio communications used by humanitarian actors operate on open frequencies, and are not encrypted. An unencrypted signal means that anyone on the same frequency can listen and hear all communications. Many governments may require agencies to not use encrypted signals simply because they too wish to monitor activities of humanitarian agencies. National legislation may also limit the types of data that can be transmitted over radio, such as data. Even if an organisation is using a fully encrypted radio signal, if a radio is lost or stolen by a bad-faith actor they may still be able to eaves drop on radio communications.

*Some* radio networks are highly advanced, and allow users to call each other directly through a numerical dialling system, similar to a telephone. In instances where users may reach each other directly, it is advised to carry out as much communication directly as possible. The majority of radio networks operate on a “broadcast all” system however, meaning anything said into one radio unit can be heard across all units within reception and listening range.

Agencies using mobile radio for voice communication should always operate as if someone else is listening in on communications.

- Users should communicate only using calls signs – referring to themselves or each other by each persons assigned call sign. The list of call signs can be generated based on organisational structure or the local security personnel.
- Users should avoid talking about money, high value shipments, sensitive personnel issues, or anything else that might attract violence or theft. If certain key issues must be discussed over the radio, users should utilise pre-defined and mutually agreed upon code words or phrases.
- Users should establish common codes for identifying vehicles, geographic locations or buildings. Use of these codes will help speed up communication or remove ambiguity, but also make it harder for listeners to know exactly who is where.
- If at any time a radio is lost or unaccounted for, it should be reported immediately to the respective security focal point.

### **Radio Checks**

The act of intentionally calling from one radio to another to ensure proper connectivity is known as a “radio check.” The need and frequency of radio checks depend on the security constraints of the organisation and the operating contexts. In any context, it is advisable to conduct regular checks to ensure operational continuity. Unlike modern mobile phones, many radios generally cannot identify signal strength, and users may not know if they are within communication range or not.

- **Routine checks** – organisations may wish to conduct routine radio checks, including daily, weekly or monthly, depending on the security needs of the site. The routine checks might include a base station calling every single radio user separately by call sign, and asking the radio user to respond. Radio users should be advised of the radio check schedule, and their adherence to the schedule should be recorded. Any radio user that does not check in may be a sign of a faulty radio, or lack of understanding of the system.
- **Movement Checks** – Agencies may also wish to establish routine checks dedicated to the movement of vehicles. Depending on the security context, vehicles may be required to check in at pre-set intervals – usually every 1-2 hours – to provide status and location. This ensures that the base knows where the vehicle is, and that the vehicle is still within radio range to avoid possible gaps in coverage in case of incident.

### **Dedicated Radio Operators**

As part of routine security measures, many humanitarian agencies choose to hire and train full time radio operators. The profile of a radio operator might vary, but the general function is to physically sit near a base station, route messages and conduct radio checks as needed. A dedicated radio operator is usually cross trained in variety of radios and communications devices, and may be expected to operate multiple communications base stations at once.

Radio operators are usually used in larger operations with multiple parties moving between different locations at once. Radio operators also work closely with IT, vehicle fleet and security personnel in the process of tracking movement, flagging emergencies and ensuring proper communications are functioning at all time.

The duties of a radio operator might include:

- Updating a manual tracking system indicating where vehicles are.
- Conducting daily radio checks.

- Sending out updates or emergency signals.

When conducting daily radio checks, radio operators should have a list of all personnel and call signs, and should keep a running daily tally of who may be in the area and who is responding to radio checks. While conducting routine checks on vehicles in movement, radio operators may be expected to update movement boards or even record movements on a map. The rules and requirements for both routine checks and movement monitoring will depend on the needs of the agency and the security context.

### **Usage Requirements**

Depending on the contexts, users may be required to keep a radio near them and on at all times. To facilitate this, all users should have access to:

- Spare batteries.
- Charging equipment.
- Carrying equipment (cases, clips).
- Maintenance instructions.

### **Programming of Radio Equipment**

The act of programming a radio might include pre-defining:

- Frequencies of operation.
- Communications channels.
- Radio specific IDs for direct calling.
- Password protection.
- Encryption or other special functions.

Not all radios have the same functions, and even different models of radio coming from the same manufacturer might have a different set of functions. As an example, not all radios units will have the ability to establish direct calling links or offer higher levels of security such as encryption – these are usually specified at the time of procurement.

At a bare minimum, radios used by humanitarian agencies should have programmable frequencies and multiple communications channels:

- The **specific frequency** of use is usually defined by state or national authorities, and use of unauthorised frequencies may result in punishment. Different types of radio equipment have a defined spectrum in which they can operate, but within this band there are numerous specific frequencies that multiple parties may use at the same time without interfering with each other.
- The **communications channels** used are usually defined by the humanitarian agency. It is very common to define channels numerically (1, 2, 3...) however some agencies may wish to use specific names such as “calling channel” and “emergency channel” for clarity sake. A properly programmed radio will display the pre-defined channel name on the readout screen, if available. In instances where multiple agencies are using the same network, the channel names/numbers are usually defined by the lead agency controlling the network.

Programming radio equipment can be a very complicated task. Different manufacturers of radio equipment have different proprietary hardware and software packages to enable programming, and there is no one single method of programming all radios.

When agencies are planning a radio communication network they should consider the following:

- Who will be responsible for programming the devices? Does the humanitarian organisation in question have the capacity to program the radios themselves, or will the process need to be outsourced?
- What types of features are required for radios in their radio network?
- What is the plan for servicing equipment or making changes in the future?

Many accredited radio equipment sellers will have the capacity to program radios to the client's specifications for a fee, however the client will need to know all the required information up front. Prior to purchasing radios, humanitarian organisations should investigate what state and local laws are to avoid any restrictions, and should investigate the process for applying for any licenses or waivers utilising open airwaves.

Agencies may also investigate hiring a dedicated radio technician who can install, program and troubleshoot radio networks as needed. Another possibility is speaking with other NGOs or UN agencies to determine who may have spare capacity to support programming, or who may offer services for a small fee.

## Very High Frequency (VHF)/Ultra High Frequency (UHF)

Very High Frequency (VHF) and Ultra High Frequency (UHF) radios are by far the mostly commonly used radio type by governments, military, police, maritime organisations, emergency responders and other entities that operate in environments when regular communications networks may be inconsistent or not properly functioning.

VHF radio waves occupy band between 30 to 300 megahertz (MHz), while UHF radio waves occupy the range between 300 MHz and 3 gigahertz (GHz). VHF/UHF radio waves are propagated by a line of sight path; they will not reach around the curvature of the earth and they can be blocked by hills, mountains and other large dense objects. The maximum broadcast distance of a VHF radio is around 160 km while the maximum broadcast distance of UHF radio is around 60 km – these distances are greatly variable however and depend on a number of operating and environmental factors. In almost all contexts, VHF and UHF signals will not reach their maximum potential distances.

Approximate distances for VHF communication:

Communication Devices	Approximate Communication Range
<b>Handheld to handheld</b>	about <b>5 km</b> depending on terrain
<b>Vehicle to vehicle</b>	about <b>20 km</b> depending on terrain
<b>Vehicle to base</b>	about <b>30 km</b> depending on terrain
<b>Base to base</b>	about <b>50 km</b> depending on terrain

*Adapted from RedR*

There are a wide variety of applications and devices for VHF/UHF radio transmission, including

traditional FM radio and broadcast television, GPS devices and mobile phones. VHF/UHF waves can penetrate buildings and other radio transparent structures, but any object will cause some form of interference; though a VHF/UHF radio may work in a building, the signal will be weaker, and the more buildings in the surrounding area the more impacted the signal will be. Use of VHF/UHF communications in dense urban settings, thick forests, or deep valleys will significantly limit ranges even further.

## Common Problems with VHF/UHF Communications

Some common problems encountered by users of VHF/UHF might include:

**Dead spots** - areas where signal is impossible to find and communication cannot occur. Dead spots are caused by an object of sufficient size/density blocking the incoming/outbound signal. If radio users are in a dead spot, they may need to relocate to obtain a proper connection, if that means moving only a few meters in one direction or another.

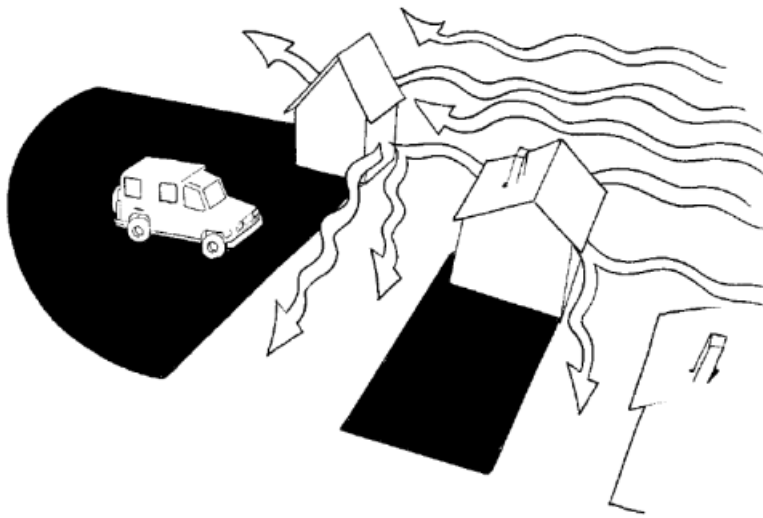

Adapted from [ICRC "Staying Alive"](#)

**Electromagnetic Interference** - Objects that produce sufficient electric currents, such as overhead power lines or electrical plants can also block or interfere with signals, even if the source of the electromagnetic radiation isn't directly between the two radios experiencing interference. If experiencing issues, radio users should try moving away from overhead powerlines or other possible causes to get a better signal.



Adapted from [ICRC "Staying Alive"](#)

**Antenna Direction** - VHF/UHF radios transmit signals using line of sight propagation, meaning that their signals work best when perpendicular to the earth's surface. For the best experience and best signal, the long edge of the antenna should be pointing at the horizon, while the tip of the antenna should be facing the sky.

## VHF/UHF Walkie Talkies

Despite the relative limitations of using VHF/UHF for two way communication, the vast majority of response organisations prefer VHF/UHF radios due to their portability. The size of the VHF/UHF wavelengths don't require massive or specialised antennas, while the relatively low energy requirements enable long lasting battery powered portable "walkie-talkies." Handheld walkie-talkie radios can be relatively expensive, but they are still cheap enough to buy in bulk and distribute to key personnel on the move.

### Example Mobile Handheld Walkie Talkies



---

There are a variety of manufacturers of VHF/UHF handheld radio equipment available to humanitarian agencies. Though different devices from different manufacturers can be programmed to operate on the same frequencies and interoperate with each other, buying two different models of radio is strongly discouraged. Handheld radios have a variety of removable and replaceable parts, and having a standard fleet of handheld radios will greatly simplify for maintenance and repair.

**Replacement Antenna**

**Removeable Battery**

---





Users of VHF/UHF radios should know how to properly turn on their radios, adjust the volume, and cycle through different channels. Each radio manufacturer may have slightly different standards and modes of operation, so users should familiarise themselves with operation.

Depending on the security environment, users may also be required to keep their radios on at all times, and continually charged. Users should be supplied with charging base stations and spare batteries so radios can be operated even in power outages. Users should also familiarise themselves with how to charge and replace batteries, and if a radio only holds a charge for less than 2-3 hours should ask for a replacement battery.

### **VHF/UHF Base Stations**

Roof mounted antenna installations for VHF/UHF base stations are noticeably larger than antennas on the mobile handheld radios, however they are still relatively small compared to other types of wireless communication. A roof mounted VHF/UHF antenna will need to be able to broadcast/receive on the same frequencies as the intended mobile radios, and be compatible with base station in use.

A roof mounted VHF/UHF antenna will also need to support duplex two-way communication. Some VHF/UHF antennas are pre-made to handle both incoming/outgoing channels at the same time, while other configurations will require installing two separate antennas relatively close to each other. Roof mounted antennas will connect to radio base stations through proprietary cables, and unless otherwise configured, the antenna will draw its power from the base station unit.

Roof mounted antennas should be installed at the highest point of the building roof, with no obstructions on any side. The antenna must be installed vertically, so the long edge of the

antenna is pointing at the horizon while the narrow point is facing directly upwards. To facilitate this usually, the antenna is attached to a sturdy metal pole which is attached to the side of the building. The metal pole can also be used to increase the height of the antenna as needed. Some agencies may attach antenna to stand alone radio towers to reach sufficient height. Irrespective of what the VHF/UHF roof mounted antennas may be attached to, the proprietary cable should still be able to reach the base station, and the antenna should always be grounded in case of lightening strike.

### **Example Roof Mounted Antennas**



### **Vehicle VHF/UHF Radios**

VHF/UHF vehicle transceiver installations are also extremely common. A variety of manufacturers produce vehicle installation kits and vehicle specific radios, which are permanently mounted on, in or under the dash of the vehicles. A vehicle installed VHF/UHF radio will not noticeably increase its communications range or functionality, and the same limitations that apply to all VHF/UHF communications apply to mobile vehicle installed VHF/UHF radios.

The advantage of a vehicle installed radio however is that it draws its power from the car's battery meaning significantly longer periods of operation as long as the vehicle's battery is functioning and/or the vehicle is in motion. A VHF/UHF vehicle transceiver will be permanently wired to the vehicles electrical system, and requires special installations as holes may have to be drilled in the dash and conductive cabling pulled into the engine of the vehicle where it will be connected to the battery. Wires will also have to permanently connect to the antenna, and

may require special installation as well. VHF/UHF vehicle antennas are also less obtrusive than other radio antennas and can be mounted with simple magnets.

**Example Car Mounted UHF Radio**



**Example UHF Car Antenna**



## High Frequency (HF) Radio

Another widely used radio band used by humanitarian actors is the High Frequency (HF) range. HF is used less frequently by commercial or governmental organisations, but due to the extremely long range communication provided by HF, it has become popular for use in aviation and remote exploration.

HF radio waves occupy the band between 3 and 30 megahertz (MHz), and are part of what is known as the shortwave band. HF transmit using “skywave” or “skip” propagation, giving HF the ability to send and receive over long distances. HF radio waves occupy a spectrum that interacts with the earth’s atmosphere in a very specific way – when broadcast at an angle towards the they will refract off the ionosphere and back towards the earth’s surface where it will bounce back multiple times. HF radio wave are capable of broadcasting signals beyond the horizon and around the curvature of the earth’s surface. In optimal conditions and using the appropriate set up, HF waves can even be transmitted between continents, however this should never be relied on as a primary mode of intercontinental communication. HF radio waves refracting off the ionosphere greatly reduce dead spots and radio “shadows” cast by hills our mountains, however dense surrounding buildings may still effect HF usage.

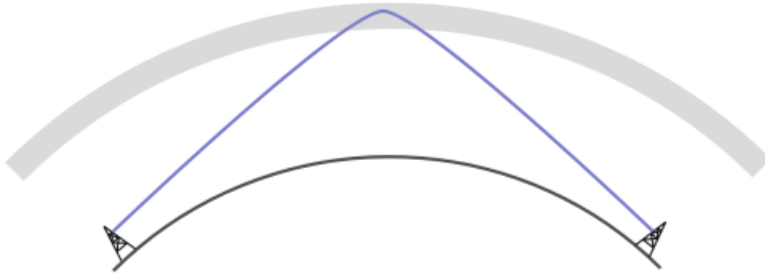

While HF may offer an advantage in the distance of its communication, it also comes with limitations. Notably, the equipment required to transmit and receive HF signals is bulky and large, and requires a significantly larger antenna and a larger energy source. Generally speaking, there are no good solutions for handheld mobile HF radios used by humanitarian agencies – HF is almost always limited to vehicles and stationary buildings.

### **Vehicle HF Radios**

HF communication has become the default for vehicle communication for many large humanitarian agencies. Due to the fact HF signals can reach far beyond VHF/UHF, and given the size of the equipment, HF is an excellent complement to other forms of communication and a vital for vehicle security.

The vehicle mounted HF transceivers are very similar to other vehicle mounted radio units – HF radios are installed on, in or below dashboards, and must be permanently wired to the vehicle's battery or electrical system. Additionally, given the placement of the HF antenna, additional wires will have to be run through the chassis or body of the vehicle to properly reach the transceiver.

A distinguishing factor of an HF antenna is its sheer size. The length of an HF antenna installed in a car – sometimes called a "whip" - may be several times the height of the vehicle. Also, while the antenna may not be especially heavy, its length will apply pressure to the base of the antenna as it encounter breeze or as the vehicle starts and stops. The HF whip will need to be securely bolted to the body of the vehicle, usually on the front or rear bumper.

## Example HF (Codan) Vehicle Antennas

---



---

The antenna itself may cause security concerns. While the radio is in use, there is a significant amount of electricity flowing to the antenna if only for a short period of times. Persons or animals in contact with the antenna while in use may suffer heat or electrical injuries. Additionally, the height of the whip can easily become caught on trees, bridges, or any low hanging materials or structures, damaging the structure, the whip or both.

To remedy the height issues, users may want to tie back or anchor their HF antenna to a roof rack or other anchor point on the roof of the vehicle. While this is a perfectly acceptable solution and does not impact the functionality of the radio, users should be aware:

- Anchored whips are under high tension, and may injure people or animals if it breaks free.
- Whips can only be anchored using special built tie downs, available from the

manufacturer.

- The whip should never be closer than one meter to the body of the car.

### HF Vehicle Antenna Configurations

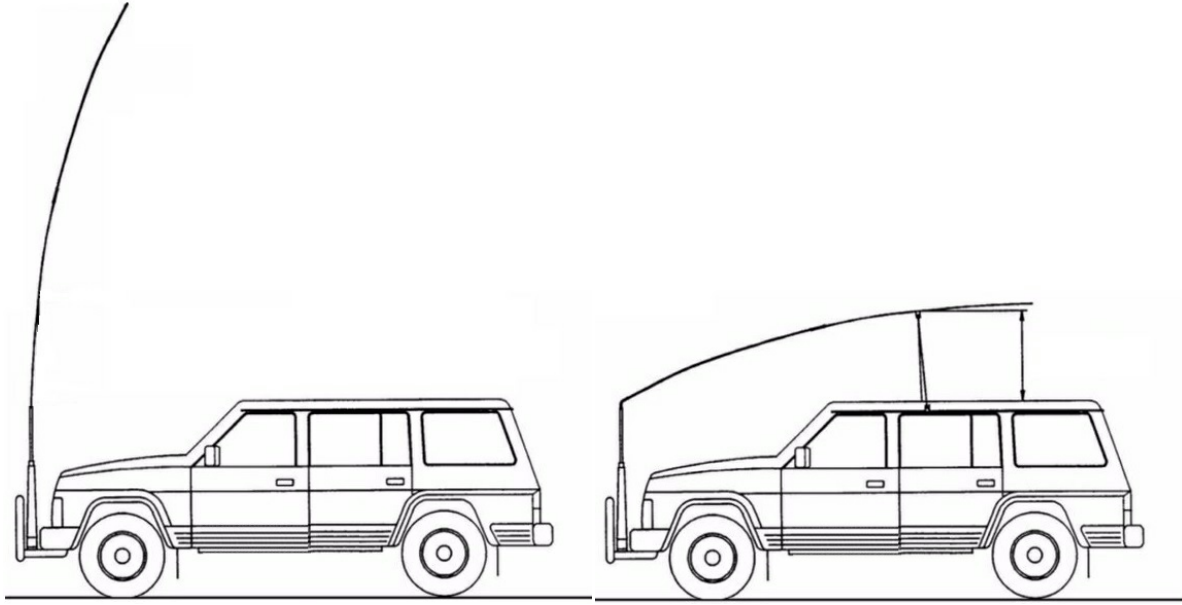

### HF Base Stations

The size and usage of an HF base station isn't dissimilar to other radio base stations, however specific usage requirements will depend on the specific unit and the programming needs of the agency.

A significant difference with using permanent HF building installations however is the size and orientation of the HF antennas. Due to the relative size of the HF radio wave, HF base antennas need to be extremely large. To accommodate this, HF antennas tend to be made of flexible materials that can be shaped to match the contours or needs of the grounds. The most common HF antennas come as di-polar - two separate conductive cables interrupted in the middle. The two separate cables are loose hanging, but separated by rigid bodies that prevent the two from making contact with each other.

### Di-Polar HF Antenna

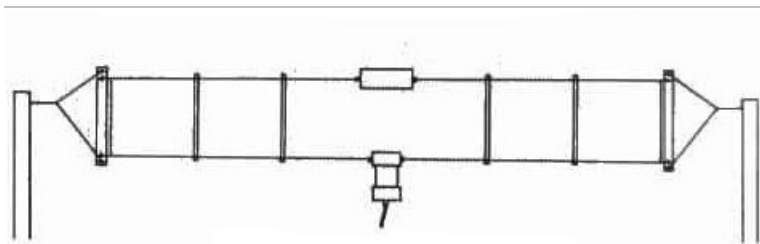

The HF di-polar antenna can take up quite a bit of space in a compound area. The antenna can be up to 40-50 meters long insulator to insulator, and actually be longer accounting for the tie

downs and the anchors. HF Antennas also must be mounted fairly high above the ground. The general rule of thumb is radio antennas should be mounted at least half the height of their corresponding wavelengths. For HF radio installations, it is recommended to install the antennas at least 12-15 meters above the ground.

Considering the ground space required to accommodate this, there are several configurations that users can adopt:

#### **Horizontal Configuration**

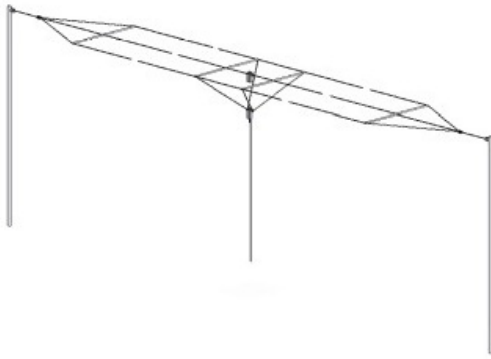

#### **Inverted V Configuration**

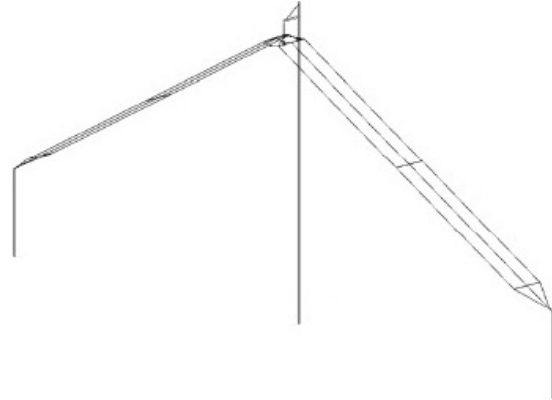

**Horizontal Configuration** – The di-polar antenna is tautly suspended from both ends at equal heights. The cable connection to the base station is free hanging, though ideally it will still be secured to something near the ground level or anchored to a sturdy pole to prevent movement in the wind, and to take weight off the installation. The horizontal configuration is considered the best case, and will carry a signal the furthers.

**Inverted V Configuration** – To save ground space, agencies may opt for the inverted V configuration, where the sides of the di-polar antenna are sloped like a tent. Important components to an inverted V configuration:

- The angle formed by the inside of the V should never be less than 90 degrees. The closer to flat the better.
- The middle will need to be suspended from a strong, non-conductive material using the proper anchor.
- The anchors at the low points of the slope should still be raised above the ground, connected to “stub masts”. Ideally, the main mast would be raised higher than the minimum height to accommodate the height of the lower points.

Any form of antenna and mast configuration will need to be safely secured. Each antenna type comes with a certain wind rating, and users should understand what annual weather might impact antenna selection.

Additionally, HF antennas can consume and output large amounts of electricity. HF di-pole antennas while in use consume 250-350 watts of power on average, and can have peak consumption of up to 1,000 watts. Di-polar antennas are largely just exposed metal, and any thing bridging the connection between those two wires will pose a serious risk. Tree branches or trash might catch fire, while wires can seriously injure or kill humans or animals. At no point should humans or animals be able to grasp or bump into the wires of an HF radio, and if a radio wire is knocked down, persons in the vicinity should be instructed to stand back until the power is cut.

# Using Radios For Voice Communication

The overall privileges and limits of the use of radio communication may vary from organisation to organisation, however it is strongly advised that each organisation establish and develop its own policies for the proper use of radio, and disciplinary plans for misuse of radio equipment.

## Channels

When using any network sometimes there are separate calling channels used to establish communication with other radio users, who then specify another dedicated channel. As soon as such communication is established both radio stations should move to determined talking channel to leave calling channel for other stations to establish contact. The use of calling channels is used especially in networks with high volumes of shared traffic, or in networks hosted by third parties such as UN repeater networks which multiple humanitarian agencies might use.

## Etiquette

In general, there are rules that should be followed when communicating via voice using two-way radio. These might include:

### Use of Pro-Words

Procedural Words (Pro-Words) are a pre-defined set of short phrases with precise meanings that have been developed to help network users and operators keep their transmissions brief and prevent confusion and misunderstanding. It is important that one understands these words and their meaning, to be able to understand what is said on the radio network and to be able to send short and precise messages. The following are commonly used pro-words and their meanings:

<b>Pro-Word Phrase</b>	<b>Meaning</b>
<b>Affirmative</b>	Yes/Correct
<b>Break, Break, Break</b>	Interrupt ongoing transmission for an urgent message
<b>Correct</b>	You are correct, or what you have transmitted is correct



**Pro-Word  
Phrase**

**Meaning**

---

**Negative** No/Incorrect

---

**Negative  
Copy** Your last message was not understood

---

**Wrong** Your last transmission was incorrect

---

**Over** This is the end of my transmission to you and a response is expected. Go ahead and transmit.

---

**Out** This is the end of my transmission to you and no answer is required  
**Do not use OVER and OUT together!**

---

**Relay To** Transmit the following message to the identified addressees/recipients

---

**Roger** I have received your last transmission satisfactorily

---

**Say again** Repeat the last message.  
**Do not say "repeat" on the radio! Repeat is commonly used by militaries to request soldiers to continue firing a weapon.**

---

**Stand-by** Do not transmit until contacted. I need extra time.

---

**Use the NATO Phonetic Alphabet:**

The NATO phonetic alphabet is frequently used to remove ambiguity from radio communications. Voice commands over radio can be difficult to understand or signal strength than be weak. To work around this, radio users will frequently use the NATO phonetic alphabet when spelling out words or discussing single letter codes. As an example, a mobile ambulance vehicle might have the call sign "Mobile Ambulance 1" or MA1 for short. When pronounced using the phonetic alphabet, it would be spoken as "Mike Alpha 1".

<b>Letter</b>	<b>Phonetic</b>	<b>Letter</b>	<b>Phonetic</b>
<b>A</b>	Alfa	<b>N</b>	November
<b>B</b>	Bravo	<b>O</b>	Oscar
<b>C</b>	Charlie	<b>P</b>	Papa
<b>D</b>	Delta	<b>Q</b>	Quebec
<b>E</b>	Echo	<b>R</b>	Romeo
<b>F</b>	Foxtrot	<b>S</b>	Sierra
<b>G</b>	Golf	<b>T</b>	Tango
<b>H</b>	Hotel	<b>U</b>	Uniform

Letter	Phonetic	Letter	Phonetic
<b>I</b>	India	<b>V</b>	Victor
<b>J</b>	Juliet	<b>W</b>	Whiskey
<b>K</b>	Kilo	<b>X</b>	X-Ray
<b>L</b>	Lima	<b>Y</b>	Yankee

**Keep messages short** - Messages sent over the radio must be brief and to the point. If longer conversations cannot be avoided, they should be broken into segments. Long conversations may block other users from accessing the network as well.

**Use Radios for Official Business Only** - Communication should be kept to official business. No personal business should be conducted over radio waves, including personal conversations.

**Making Calls** - Before making a call, always verify that the intended radio channel is not in use by listening in for a few moments. If needed, increase the audio output.

The general procedure for making a call is as follows, with a radio user with the call-sign BF3 calling another user:

*(BF3 Calling) - "BF31, BF31 (from) BF3"*

*(BF31 Responding) - "BF3 go ahead."*

*(BF3 Responding) - "Please give me the status of shipment 12345, over."*

**Example:**

*(BF31 Responding) - "12345 is packed and shipped already, over."*

*(BF3 Responding) - "Thanks, nothing further, BF3 out."*

*(BF31 Responding) - "BF31 out."*

If for some urgent reason an ongoing conversation needs to be terminated, the procedure is as follows:

**(Ongoing conversation) - (Talk)... over**

**(BF1 Breaking in) - Break, Break. BF3, BF3 (from) BF1**

**Example:** **(BF3 Responding) - BF1 Move channel 3, over**

**(BF1 Responding) - Moving channel 3, BF1 out**

**(Ongoing conversation) - (Talk)... Over**

---

*Adapted from International Medical Corps*

**Call Quality** - To determine the quality of the audio connection, or if the transmission is already difficult, users should ask "How do you read?" To clarify radio strength and clarity, users may state "I read you loud and clear" however users may also state "I read you "X" by 5" where "X" is a number between one and five. Five corresponds to a loud and clear transmission and zero means complete lack of communications/signal.

## Common Problems with Radio Communication

<b>Radio Won't Turn on.</b>	<ul style="list-style-type: none"><li>• Is the battery charged?</li><li>• Is the radio connected to a power source?</li><li>• Is the power source under powered or weak?</li></ul>
<b>Transmissions are not being received, or no one is responding.</b>	<ul style="list-style-type: none"><li>• Is the transmission being sent on the intended frequency?</li><li>• Is the radio in a dead spot?</li><li>• Is the radio within the expected transmission range?</li><li>• Is the antenna connected properly?</li><li>• Are the other radios possibly off?</li></ul>
<b>Signal is weak or broken</b>	<ul style="list-style-type: none"><li>• Are there atmospheric or environmental factors that may be interfering with the signal?</li><li>• Is the radio being used indoors or around tall buildings or trees?</li><li>• Is the radio being operated around power lines or other radio equipment.</li></ul>

---

## GPS Systems and Devices

Global Positioning System (GPS) enabled devices and services are quite common for modern day technology such as computers and cell phones, and many current users interact with systems benefiting from GPS daily. The underlying concept behind GPS was once considered relatively exotic, and was used primarily by governments.

GPS enabled devices work by speaking to a loose network of navigational satellites called the Global Navigation Satellite System (GNSS) that continually orbit the earth at a variety of orbital altitudes and speeds. GNSS satellites continually transmit a weak radio signal that devices on the ground can detect. A GPS enabled device requires concurrent line of sight to at least three GNSS satellites to triangulate its position on the earth. Navigational satellites were first launched in the 1970s by the United States government for military use only, however by the mid-1990s GPS had become widely available for commercial use. Today, the GNSS constellation is made up from dozens of satellites from a variety of countries.

## Using GPS Coordinates

GPS enabled devices communicate in a coordinate system, which are generally known as “GPS Coordinates”. GPS coordinates define an exact location the surface of the earth within a pre-defined grid system. There is more than one grid system used, however the vast majority of communications systems are built on latitude and longitude:

**Lines of Latitude** – Lines of latitude are horizontal lines that stretch from east to west across the globe. The longest and main line of latitude is called the Equator.

The Equator is represented as 0° latitude, while the north and south poles are both represented as 90°. The space between the equator and the poles are evenly distributed between 0 and 90.

Latitude lines are expressed as 0-90° North (N) and 0-90° South (S), written as (example):

**32° N**

---

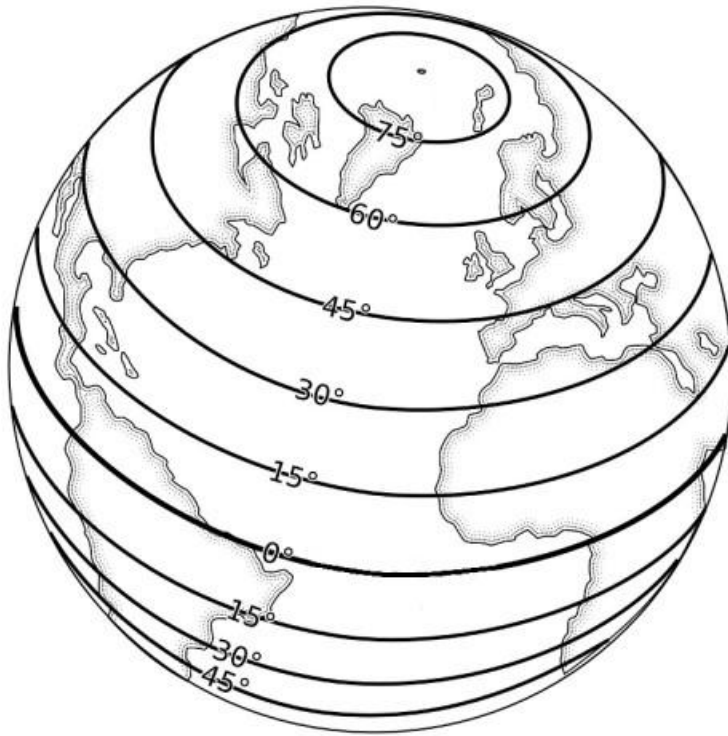

**Lines of Longitude** - Lines of longitude are vertical lines that stretch from the North Pole to the South Pole. The main line of longitude is called the Prime Meridian.

The Prime Meridian is represented as  $0^\circ$  longitude, while vertical lines east and west increase incrementally until  $180^\circ$ , making  $360^\circ$  in total.

Longitude lines are expressed as  $0-180^\circ$  East (E) and  $0-180^\circ$  West (W), written as (example):

**$163^\circ$  W**

---

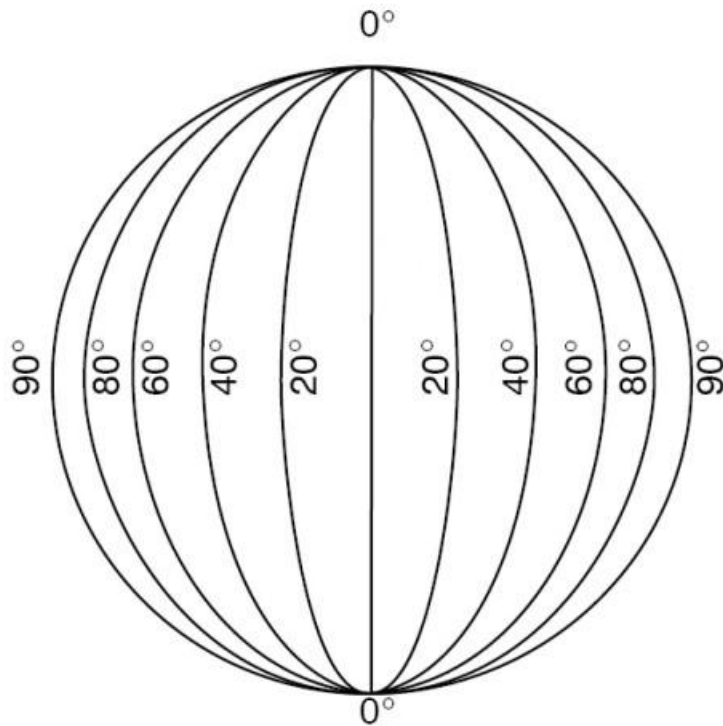

Combined together, the grid structure generated from combining longitude and latitude would look like:

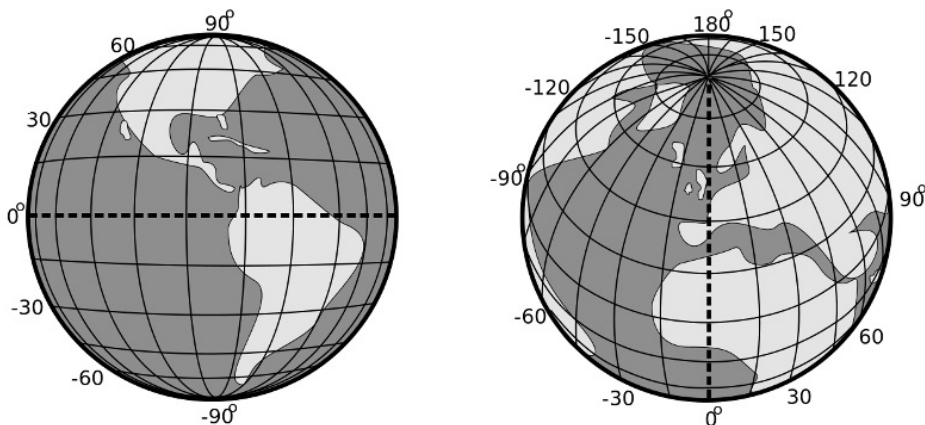

To more accurately describe GPS coordinates, the lines of longitude and latitude are broken down into smaller and smaller increments. Detailed incremental GPS coordinates can provide accurate locations anywhere on the earth's surface to down to less than a square meter.

In all GPS coordinates, the North/South orientation is always expressed first, followed by the East/West orientation. Unfortunately, there are multiple methods of expressing these coordinates, and they are not interchangeable. The different GPS coordinate formats are:

GPS Coordinate Grid Type	Explanation	Example GPS Coordinate Layout
<b>Degrees, Minutes, and Seconds (DMS)</b>	The most common historical method of expressing GPS coordinates was in degrees, arc minutes and arc seconds. While the degree number matches the line of latitude and longitude, minutes and seconds are expressed in units of 1-60, with sixty arc minutes in a degree. Traditional coordinates also require a N, E, W, or S to indicate their relation to the equator or prime meridian, as the numbers alone can represent different locations.	<b>41° 49' 17.3" N, 12° 24' 27.0" E</b>
<b>Decimal Degrees (DD)</b>	Decimal degrees are quickly becoming the most common method for expressing GPS coordinates, as they are the easiest to read and understand for computer systems. A decimal degree is expressed as a whole degree (latitude or longitude number) followed by a decimal point and up to six numbers past the decimal point. The numbers past the decimal point are essentially fractions of a whole degree, and based on units of 1-10. Decimal degrees west of the prime meridian or south of the equator are expressed as negatives. As an example, a point off the coast of Peru (both in the southern hemisphere and western hemisphere) would be expressed as:  <b>-9.791500, -81.199971</b>	<b>41.821468, 12.407512</b>
<b>Degrees and Decimal Minutes (DMM)</b>	A hybrid between regular arc minutes/seconds and decimal degrees, where the regular arc minutes and seconds are expressed in decimal format.	<b>41 49.2881 N, 12 24.4507 E</b>

When generating and using GPS coordinates, it is important to understand the differences between the different formats! Because arc minutes and seconds use a base 60 system while decimal degrees use a base 10, the same location will have two different numbers. If someone is recording GPS coordinates from a device that reports in arc minutes/seconds, users must remember to convert the coordinates to decimal degrees if they plan on using tools that require decimal degrees, and vice a versa.

## GPS Devices

There are number of GPS devices available on the market for humanitarian organisations, all of which will have their own user requirements and instructions. It is important that users understand what the intended use of the GPS device is when making a selection.

**Offline/Standalone** - Many GPS devices are designed for the sole purpose of taking GPS readings. Usually these devices have a simple interface, and a powered by disposable or rechargeable batteries. Offline GPS units are frequently used for maritime, aviation and military, but are also use for wilderness orientation, extractive industries, or any application that requires being far away from a mobile or internet connection. Offline GPS devices are



generally just passive receivers of GPS signals from GNSS satellites, and will provide a flat set of coordinates when in use. Some GPS devices have mapping functions or the ability to leave waypoints. The need for these additional features will depend on the use and the agency.

**Online/Phone Based** – Most modern smart phones come with GPS capability, as well mapping and tracking applications. While most users are familiar with phone based GPS apps, there are a few important things to consider:

- Many phones also triangulate position based on mobile phone towers, and may not necessarily be getting a solid GPS reading from a GNSS satellite.
- Phones may be delicate, be less water/dust resistant, and have shorter batter lives than dedicated GPS devices.
- Without persistent connection to the internet, some GPS apps will not work.

Before relying on a smart phone as a primary GPS device, users should consider:

- How long will the device be required to operate for?
- Will the device withstand the environmental conditions required for the operation?
- Will this smart phone actually work without cellular connection?

## GPS Coordinate Converter Tool

## Managing Fuel

Fuel management can be a complicated task, and anyone approaching the problem maintaining a fuel supply needs to understand the benefits and limitations. Wherever possible, humanitarian organizations should seek to outsource fueling services, using direct delivery or refueling stations where possible. Unfortunately the humanitarian landscape requires direct active management of fuel supplies in many instances.

As a general rule, fuel should be treated as a specialized sub-category of storage and transportation, and requires special attention. Humanitarian agencies working in disaster settings should consider making special precautions and procedures for fuel management, especially if fuel management becomes a large part of the portfolio of activities.

## Common Terms in Fuel Management

**Dispenser** A nozzle, hose or other device that is used to deposit or deliver fuel from a storage container to a vehicle or another storage container.

---

**Flowmeter** A meter that is used to record the follow of fuel, usually liquids measured in litres. Flowmeters are usually used for recording usage over time.

---

**Drum** A common unit for transporting liquid fuel. The most common unit of drum is a 200 litre drum.

---

---

<b>Discharge</b>	The act of draining or removing liquid or gas from a tank/drum/canister or other form of container.
------------------	---

---

<b>Hot Work</b>	Any activity or process that generates a source of ignition, this could be through a flame, heat or a spark. Activities such as welding are considered "hot work."
-----------------	--

---

<b>Flashpoint</b>	The temperature at which flammable fuels become combustible when exposed to an external ignition source. Different substances have different flashpoints.
-------------------	---

---

<b>Fuel Reservoirs</b>	Any container of any kind that used to hold fuel. This may include canisters, drums, tanks, bladders and other form factors.
------------------------	--

---

<b>Phase Separation</b>	The gradual separation of a mixture of compounds into two distinct compounds. In the case of liquid fuel, phase separation entails fuel separating into different layers, including impurities and water.
-------------------------	---

---

<b>Stale Fuel</b>	Fuel that is old and has become impacted by chemical changes. Stale fuel is inefficient and can impact the performance or even damage engines.
-------------------	--

---

**Terminology**

It is common to use the term "fuel" to refer to different products. Furthermore, equal terms in different languages refer to different product types. The following translation sheet, illustrates the basics on fuel terminology:

French	English (US)	English (UK)	Spanish	Use	Handling Specifics
COMBUSTIBLE FUEL (Carburant)	FUEL (Motor fuel)	FUEL (Motor fuel)	COMBUSTIBLE (Carburante)		
METHANE	METHANE	METHANE	METANO	Town gas	Gas
ETHANE	ETHANE	ETHANE	ETANO		Gas

---

French	English (US)	English (UK)	Spanish	Use	Handling Specifics
PROPANE	PROPANE	PROPANE	PROPANO	Bottled gas for fridge, heating, etc.	Gas
BUTANE	BUTANE	BUTANE	BUTANO	Bottled gas for fridge, heating, etc.	Gas
G.P.L.	L.P.G.	L.P.G.	G.P.L.	Liquefied Petroleum Gas	Gas used for car fuel, (adapted engine)
AVGAS, LL100 Essence Avion	AVGAS, LL100	AVGAS, LL100	AVGAS, LL100	Aviation Gasoline: for piston engines	<b>Very volatile, fluid, blue colour, same smell as petrol.</b> Very flammable, explosive. Can be used in a petrol engine with 3% oil added
ESSENCE - super - normale - sans plomb	GASOLINE - premium - regular - unleaded	PETROL - super - regular - unleaded	GASOLINA - super - normal - sin plomo		<b>Volatile, fluid, colourless (or almost). Very flammable, explosive.</b> Cannot be replaced by diesel, but can replace Avgas in some aircraft. Various octane indices between regular and super
KEROSENE, JETA1	KEROSENE, JETA1	KEROSENE, JETA1	KEROSENO, JETA1	Turbine engine aircraft	<b>Same as for Paraffin but with aeronautical specifications:</b> Filtering, packing and storing.
PETROLE (Lampant), PARAFFINE (Canada)	KEROSENE (Lamp oil)	KEROSENE (Lamp oil), PARAFFIN (Oil)	KEROSENO, PETROLEO	Lamps, fridges, burner, etc.	<b>Colourless, specific smell.</b> Fuel for so-called "lamp oil" equipment

French	English (US)	English (UK)	Spanish	Use	Handling Specifics
GASOIL, GAZOLE	GASOIL, DIESEL	GASOIL, DIESEL	GASOLEO, DIESEL	Cars	<b>Greasy, yellowish, frequently coloured, heavy smell.</b> When pure, solidifies at -5°C and requires an additive (or 20% lamp oil). This also acts as the injection pump lubricant.
FUEL, FIOUL, MAZOUT	FUEL OIL	FUEL OIL, PARAFFIN	FUEL	Heating	Same as diesel without additives for low temperatures and lubrication
HUILE	OIL	OIL	ACEITE	Lubrication	Greasy, different viscosities for different uses
PARAFFINE	PARAFFIN, WAX	PARAFFIN, WAX	PARAFINA	Candles	
PETROLE LOURD	HEAVY FUEL	HEAVY FUEL		Slow engines	Heavy combustibile for marine engines and power plants
ASPHALTE, BITUME	ASPHALT	ASPHALT	ASFALTO	Road surfaces	
PETROLE (BRUT)	CRUDE PETROLEUM, KEROSENE	ROCK OIL, PARAFFIN	CRUDO	Natural state	

*Adapted from MSF*

## Fuel Storage

Storage of fuel can be extremely hazardous. Liquid or compressed gas fuels by their nature are highly combustibile and should be treated separately than other storage items.

## Choice of Storage Location

Any location used to store fuel should follow a few basic rules.

Fuel storage should always be separate from other stored items! Fuel should have its own storage location, outside of a main facility. A fuel storage location should be:

- At least 10 meters from the nearest warehouse or storage location (ideally more).
- As far away from offices and residences as possible. If possible, store fuel in a different

location than where people live and work entirely.

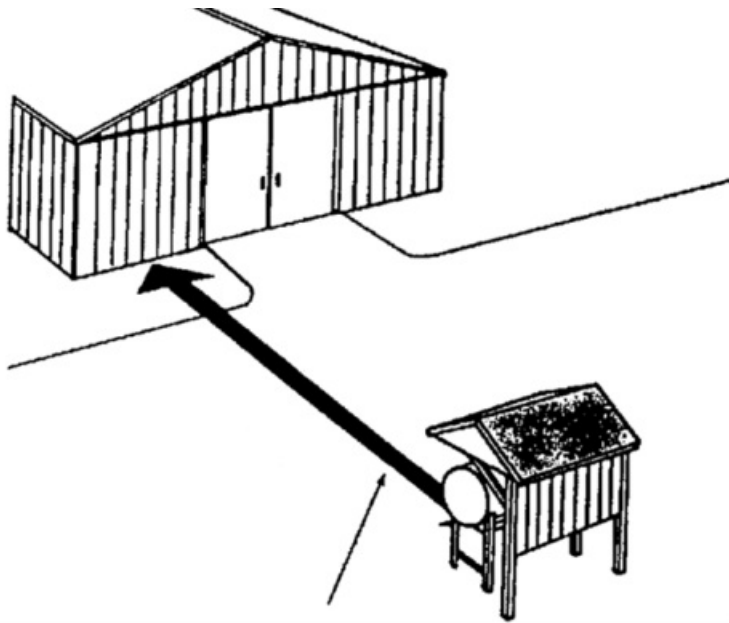

Minimum 10 metres

Access to the fuel storage locations should be controlled, and only authorized persons should have the ability to enter. All staff working around fuel storage should be informed of risks and safety procedures.

Fuel storage areas should be well ventilated to avoid the build-up of fumes, and should ideally be shaded to avoid excessive temperatures. Never store fuel in fully enclosed spaces such as shipping containers with the doors closed. Pressure, heat and increase in fumes can lead to combustion.

NEVER store fuel next to any form of chemicals that may cause a violent energetic reaction.

## General Storage Considerations

The overall size and consumption needs will determine the configuration of fuel storage arrangement. A few general rules to consider:

- Avoid storing fuel in drums as much as possible, and as much as the operation permits. Emphasize storage in tanks or bladders.
- Gasoline/Petrol should only be stored in small quantities, and in above ground, well ventilated places. Petrol is volatile and degrades quickly in ambient temperatures, and should be ordered in low volume, frequent quantities.
- Diesel fuel can generally last for up to six months before it shows signs of deterioration. Planners should aim to only store fuel for up to six months' worth of anticipated demand.
- Diesel can be stored above and below ground, but storage areas should always still be well ventilated.

Irrespective of the storage modality, planners should also consider key elements when developing fuel storage:

- Fuel storage should be on solid, firm ground, ideally purpose built for storage. Fuel in large quantities can be extremely heavy.

- Consider environmental impact. Depending on the arrangement, sawdust or sand may be scattered on the ground to absorb any spills.
- All storage locations should be well ventilated, and have adequate drainage.
- All fuels are corrosive and should not be used with plastic accessories, such as plastic buckets or plastic pipes. Also avoid contact with Teflon and tire inner-tubes.
- Managers should develop a spill response plan, and fire response plan. Plans should be continually communicated to employees or persons handling fuel.

Some general guidelines for site Identification include:

- Sites should be situated away from other potential hazards that might increase the likelihood of accidental fire.
- Fuel storage areas should have easy access for tanker trucks, if required. If vehicle refuelling is happening on site, pumps with counters should be readily available.
- There should be proper structures to accommodate shade and ventilation requirements of fuel.
- Site should have emergency exits in warehouses and perimeter walls.
- Area should not be prone to lightning strikes or seasonal fires.

*Example Storage Structures:*

**Built-up Fuel Storage Room**

- Next to generator storage area.
- Enclosed, but well ventilated.
- Separated from other storage locations.
- Fire extinguisher on site.
- Lockable door/access controlled.
- Mostly used for storage of drums/other moveable containers.



---

**Covered Fuel  
Dispensing Shed**

- Easy access for vehicles.
- Covered to prevent direct sunlight.
- Fire extinguisher on hand.



---

**Recessed / Below  
Ground Tank  
Storage**

- Large volume tanks, interconnected.
- Requires powered pumping system.
- Segregated sections for different types of fuel.
- Professional installation.
- Remote monitoring equipment in place.



Some organizations may wish to make one large central fuel repository to serve as a distribution center for other bases or other agencies operating in the area. Fuel depots or "fuel farms" can be a good idea if operations are running at sufficient scale, and managers understand the demand over the coming months, however they require specialized planning and management.

If agencies are planning specific fuel depots, things to consider:

- The fuel depot should be strategically located near consumption, but still in a safe location.
- Depots may require their own stand-alone locations, and require their own management and security on site.
- Depots should be in safe locations, free from flooding or persistent violent crime, and not

near potential targets.

- Depots should have sufficient and easy access for vehicles and refueling tanker trucks.
- Fuel storage sites should have specialized access control for visitors.
- Some countries may have heightened regulations for fuel storage locations over a certain size, including safety and security.
- Fuel depots should have an advanced fire prevention and fire suppression system in place, installed by a professional company.

## Monitoring Systems

There are a variety of monitoring systems available, including visual and remote monitoring systems.

**Remote/Electronic Monitoring** – Electronic monitors can be used to monitor both temperature and volumes of fuel storage tanks. Electronic monitors require specialized sensors to be manually inserted into fuel tanks that continually monitor the condition of the fuel. Electronic sensors are useful in that:

- They can be used to generate reports, such as stock outs.
- They can be set to trigger alarms in case of high heat or low volumes.
- The readout device does not need to be next to the fuel itself, and can be in an office or even communicate to mobile phones/computers.

Electronic monitors must be correctly installed and calibrated. When obtaining an electronic monitor, please follow manufacturer guidelines and consult with the seller.

*Example remote fuel monitoring devices:*



**Visual Monitoring** – Many tank or storage containers come with gauges or “sight tubes” that allow managers to quickly look at fuel levels without having to open the containers. Visual sight



tubes are by far the easiest and safest way to visually inspect fuel levels; other monitoring devices such as sensors or gauges can degrade over time or simply be calibrated wrong, but visually seeing fuel levels is significantly harder to misinterpret.

*Example Sight Tube:*



In case sight tubes and regular gauges are not available, managers can use what is called a “no-spark” dipstick - any clean wooden stick or ruler can be used to identify height within drums or tanks. Dip sticks work by inserting the stick into the fuel container at a 90 degree angle, and visually inspecting where the stick makes contact with the fuel.

Due to the nature of storage solutions, irregular shaped containers may make getting accurate readings difficult. It is advisable to make visual markings next to sight tubes or physically on dip sticks when adding fuel for the first time. As an example - place 20 litres (or whichever unit of measure makes sense) in the container, and then mark the relative height. Repeat with the same pre-defined interval until the container is full. This will enable faster and more accurate tracking of fuel levels.

## **Temperature Changes and Fuel**

Ambient and outside air temperatures can greatly impact fuel stored over any period of time.

**Flashpoints** - A flashpoint is the temperature at which fuel is combustible. Different types of fuel are only flammable at different ambient temperatures, meaning each one of them has an independent minimum flash point. It should be noted that even though external temperatures may not reach flashpoints for certain fuels, enclosed containers, enclosed storage spaces, or containers in direct sunlight can still reach unsafe limits.

<b>Fuel Type</b>	<b>Minimum Flash Point</b>
<b>Ethanol (70%)</b>	<b>16.6°C (61.9°F)</b>
<b>Gasoline (Petrol)</b>	<b>-43°C (-45°F)</b>
<b>Diesel</b>	<b>52°C (126°F)</b>
<b>Jet Fuel (A/A-1)</b>	<b>38°C (100°F)</b>
<b>Kerosene*</b>	<b>38-72°C (100-162°F)</b>

\*Mixture dependent

Liquid fuel also expands and contracts in changing temperatures at a higher rate than water. For example, diesel fuel stored at 25 degrees centigrade is approximately 2.5% more voluminous than diesel fuel stored at 0 degrees centigrade. Though that may seem like a small overall percent, it can certainly impact physical structures and can impact storage and consumption planning. Fuel delivered on a cold day but stored in an underground temperature regulated environment will expand, meaning users will have slightly more fuel than anticipated. The inverse is also true, however, and fuel stored in warm conditions may functionally be less than planned at the point of consumption. It should be noted that engines that consume liquid fuel still generally consume the same volume of fuel for the same activities, meaning more fuel will generally be consumed in colder climates.

When planning large reservoirs of liquid fuel to be used over a long period of time, planners should anticipate changes to volumes based on the location of storage and seasonal temperature changes.

*Change in density in diesel fuel per temperature:*

<b>Temp</b>	-	-	0	5	10	15	20	25	30	35	40	45	50	55	60
<b>C</b>	10	5													

---

<b>Litre</b>															
<b>per</b>	1.175	1.180	1.185	1.189	1.194	1.199	1.204	1.209	1.213	1.218	1.223	1.228	1.234	1.239	1.24
<b>KG</b>															

---

<b>KG</b>															
<b>per</b>	0.851	0.848	0.844	0.841	0.837	0.834	0.831	0.827	0.824	0.821	0.817	0.814	0.811	0.807	0.80
<b>Litre</b>															

---

## Fuel Storage Containers

### Drums

The global standard for storing and transporting fuel in drums is the 200 litre metal drum. There are however multiple variations, including metal drums and containers of various sizes, and drums made from plastic. Drums are useful because they are mobile, and can be moved and stored as single units, however basic caution must be taken.



Drums should be stored on pallets, separated from the ground. Though ground storage is possible, pooling water from rain/flooding, or other spilled chemicals can impact containers and contents. Pallets used for drum storage should be sturdy and not structurally compromised. Drums stored on pallets should be centred on pallets and not hanging off edges.

Drums used for storage should be in safe, usable condition. A drum in good condition:

- Should not leak.
- Should not display excessive signs of rust.
- Should be able to be safely and tightly sealed/resealed.
- Should not be so bent/damaged that it cannot be safely moved or stored.
- Should not have debris or dirt inside.

Fuel contained in a leaking drum should be transferred without delay to a drum in good condition. Be aware that there is no effective way to seal a leaking drum that is full. Drums can be sealed by welding, which should never occur around any amount of fuel. Leaks are often caused by improper handling of drums.

Full/partially full drums should not be double stacked unless there is a proper and safe racking system in place. Avoid placing full drums on top of other full drums. NEVER stack above two drums high. Full/partially full drums should be stored sitting upright. Drums should only be stored on their sides if:

- There is a safe and purpose built structure that can support the weight of the drum and contents.
- The drums are completely resealable and will not leak.
- The drums are empty.

Storing fuel in drums can be considered “modular” because the numbers and types of drums can change based on need while a fuel tank is static. There are however challenges when managing fuel in drums.

Drums containing different types of fuel should be completely segregated, ideally with a physical structure or sign differentiating the different types. Drums should be clearly marked as containing fuel, or not mislabelled as containing something else. Labels should clearly indicate the type of fuel contained inside, and the date of purchase. Intermixing of fuel types can cause problems – the wrong fuel placed in the wrong engine can permanently disable vehicles and generators.

The general rule is that fuel should be dispensed under the First In/First Out (FIFO) rule – the oldest fuel should be consumed first, and stock cards and warehouse ledgers should clearly reflect purchase dates. Long term storage of fuel should be in metal drums or containers.

For handling and moving drums comes with its own safety needs. Wherever possible persons moving drums should wear gloves.

Ideally, drums should be moved using safely operated handling equipment:

- Right sized hand truck or dolly to move individual drums.
- Drums can be moved on a pallet using a forklift, however drums must be braced and secured on the pallet.

Drums can be rolled to vehicles/storage locations, however:

- The ground must be smooth, and free from hazards that can puncture a drum or generate

sparks.

- Drums must be tightly sealed.
- Ramps or planks can be used to move up and down between two heights, but inclines should not be more than 30 degrees.

Care must be taken when opening and working around open drums. Fuel drums that are hot to the touch should be opened very slowly to avoid rapid release of pressurized content. When opening drums, the tops of drums should be cleaned off to avoid debris falling into the fuel. When checking fuel levels, use a “no-spark” dipstick – any clean wooden stick or ruler can be used to identify height within drums.

## Tanks/Reservoirs

Fuel tanks are widely considered the best practice for large scale or long term (up to six months) storage of fuel.



Tank/reservoir storage has many advantages:

- Capable of storing and moving high volumes of fuel relatively efficiently.
- Allows for adequate and necessary electronic and remote monitoring equipment.
- Minimizes accidental spills.

There are multiple configurations for tank storage, the advantage of which is scale ability. General rules for managing fuel tanks:

- The total volume stored in tanks should not exceed anticipated six months' worth of consumption.
- Tanks should be in well ventilated, and well shaded.
- Tanks should ideally have built up walled structures around them. Walled structures will need to have the appropriate holes to run fuel lines in and out of the secured space.
- If tanks are stored in the open, there should be a protective crash barrier surrounding them.
- If tanks are stored in recessed or below ground, dug-out spaces, the site should not be prone to flooding, and there should be adequate drainage.
- Tanks should be in good condition, without leaks or signs of distress.
- If different types of fuel are stored in different tanks, they should be clearly marked and clearly separated, possibly by a physical barrier.
- Tanks generally require cleaning every six months, both inside and out. When tanks are cleaned, all loose debris, build up and any other substance should be cleaned as much as possible.

- Inspections around a fuel tank should be conducted several times a year to look for signs of degradation, warping or leaking.
- Some tanks are installed with a slight incline to enable evacuation from a dedicated drain.
- In some contexts, permanent fuel storage will require special signage under local regulations. Consult with local authorities on regulations regarding marking fuel tanks.
- Using multiple tanks can function like a FIFO system – with fuel only being refilled one tank at a time, enabling distributors to “cycle” through oldest fuel first.

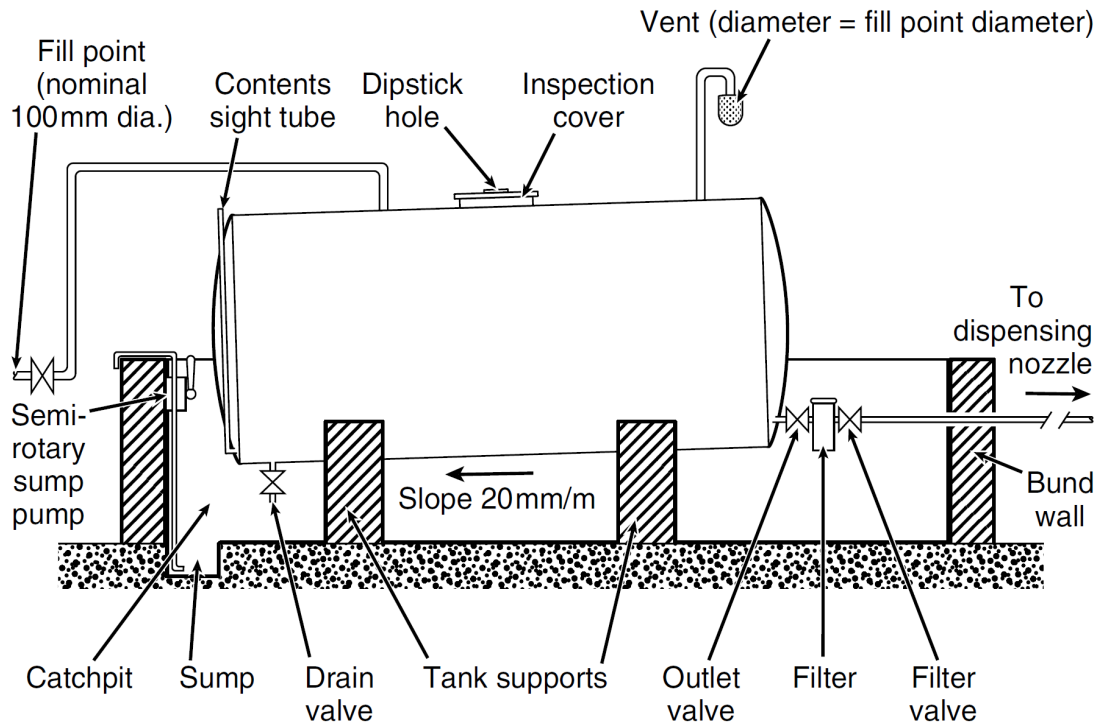

Source: Red R, *Engineering in Emergencies*

In general, tanks will come with a variety of openings, perforations.

**Fill/Discharge** – Tanks should have at least one valve dedicated to refilling and/or discharging fuel for regular consumption. Sometimes tanks will have multiple lines, one for refilling and one for discharge. Discharge lines should never be at the very bottom of the tank, and should be at least 1/10 of the height from the bottom.

**Drainage** – Used for draining tanks completely so cleaning/debris removal can be undertaken.

**Air Intake** – A small inlet to equalize pressure when discharging fuel, or to release pressure build-up when temperature differences between the outside and inside of the tank.

**Inspection Cover** – Depending on the tank, there may be one or more larger openings that allow for dipsticks, visual inspection, cleaning, or other activities. Sometimes inspection covers are used for refilling as well.

### Connected Fuel Tank Systems

Tanks can be networked or linked where required.



Linked tanks enable storage planners to “right size” their storage needs, using as much or as little storage as required. Linked tanks can even be used to push fuel between reserves with specialized equipment and pumps.

Installation and use of networked fuel tanks generally requires fairly advanced knowledge. Agencies thinking of installing and managing larger fuel reserves should first solicit outside companies that have experience with these types of projects.

## Fuel Bladders

In some contexts, agencies may employ flexible fuel bladders to store fuel. Fuel bladders have the advantage of being collapsible, meaning they are easier to transport and warehouse. This makes them extremely useful for prepositioning and rapid deployment.



Before using bladders for fuel storage there are some points humanitarian agencies should consider.

Though fuel bladders can be used for long term storage, agencies should always consider permanent hard-sided structures where available. In the event a bladder is deployed in an emergency, agencies should consider replacing them after a few months.

Fuel bladders should be made from PVC, or other chemical resistant material, and must be specifically made for the storage of fuel. Bladders should be UV resistant.

Bladders should be inspected for damage or tears along the seams before deployment/set up. Always follow manufacture recommendations for storage, handling, and overall life span. Bladder stored in excessive heat may experience degradation faster than normal.

Fuel bladders should follow the same precautions as other forms of storage. Bladders should:

- Be properly shaded.
- Clearly marked as containing fuel.
- Segregated by fuel types.
- Kept in a secured location with controlled access.
- Be kept away from open flames and sparks, and have adequate fire safety precautions

taken at all times.



## Fuel Storage Safety

### Fire Safety

The use of proper fire suppression tools are essential around fuel storage.

Any location used to store fuel should have proper fire extinguishers on hand and readily accessible. There are different classes of fire extinguishers used for different purposes.

Fire Extinguisher Classes Per Region:

American	European	UK	Australian/Asian	Fuel/Heat Source
Class A	Class A	Class A	Class A	Ordinary combustibles
Class B	Class B	Class B	Class B	Flammable liquids
	Class C	Class C	Class C	Flammable gases
Class C	Unclassified	Unclassified	Class E	Electrical equipment
Class D	Class D	Class D	Class D	Combustible metals
Class K	Class F	Class F	Class F	Kitchen Grade (Cooking oil or fat)

The only extinguisher type that should be used on fires caused by liquid and gaseous fuel are Class B fire extinguishers. Class B extinguishers work by emitting CO<sub>2</sub>, which "suffocates" the flames. Class B extinguishers technically emit a toxic compound, so persons using the extinguishers should know how to do so safely, and only operate them in the proper manner.





Large foam based extinguishers can be used for large quantities of fuel storage, but they must be rated for liquid fires.

NEVER attempt to put out a liquid or gas fire using water:

- Water may evaporate almost instantly in a fuel fire and give the flame more oxygen to expand.
- Flammable liquids tend to be lighter than water, so running water may actually spread flaming liquid around.

Fire extinguishers must be routinely checked and refilled/repressurized. Extinguishers should be checked once a month, recharged once every 6 months, or according to the manufacturer recommendations.

### Class B Fire Extinguishers



Fuel storage areas will also benefit from the use of “sand buckets” or other form of fire

suppression system using sand or dirt. Buckets full of sand should be placed on the ground near storage, and can be tossed onto flames to prevent spread. Sand buckets should be brightly coloured and clearly labelled so they are not accidentally removed or mistaken for trash.

*Example Fire Bucket:*



Depending on the size and complexity of the operation, fire or smoke detectors and alarms may be required. Local regulations may also require alarm systems around storage. Consult local authorities to understand the prevailing laws surrounding fire prevention and suppression.

Other general fire safety rules:

- NEVER conduct welding or other “hot work” near fuel storage facilities.
- Make sure all fire exits are not locked from the inside, and that all emergency evacuation areas are free from debris.
- Avoid at all costs storing reactive chemicals, medical items, food or anything else near fuel for whatever reason.

## Marking

Fuel storage areas should be well marked

Hazard signs should be written in plane the local language, but also display locally recognizable symbols. Signage should clearly indicate that smoking and other activities that might start a fire are prohibited.



Many countries and municipalities have special requirements for labeling and marking stationary fuel storage locations. Where required, signage and placards must follow local regulations. Consult with local authorities about what signage or placarding might be required in the country of operation.

*Example Regulation Signs:*



## Spill Response

In the event of a spill or leaking container, the supervisor of the facility should be notified. The person discovering the spill and the site supervisor should record information on the spill (when it occurred, why it occurred, what was spilled, volume spilled, personnel involved, etc.), and keep on file at the storage location.

In the event of spills of flammable or combustible fuel, the following steps are strongly suggested:

- Inform all persons in the immediate area to evacuate, except those involved in the clean-up process.
- Notify the safety and security focal point.
- Eliminate all ignition sources, including static electricity, electrical switches, running motors, and exposed wiring.
- Increase ventilation and exhaust fumes to the outdoors.
- Put on the appropriate protective equipment.
- Confine the spill by blocking it. This is done by using the absorbent material in the spill kit. Prevent the spill from entering drains or sewer system.
- Cover the spill with absorbent materials and safely and properly dispose of used absorbents.
- Safely dispose of contaminated equipment including personal protective equipment.
- Seal and label all containers of disposed items as hazardous waste.
- Store waste in a safe spot in or near the storage facility, ideally outside, until pickup by a licensed hazardous waste disposal company can be arranged.
- For a major spill, or one that cannot be contained, the area should be fully evacuated.

## Spill Clean-up

Materials used to support the clean-up spills should be readily available in all storage locations where fuel might be stored. These clean-up materials might include items such as the following:

- Oil absorbent pads.
- Brooms and squeegees.
- Large plastic covered trash bins.
- Nitrile gloves and latex gloves.
- Leather gloves.
- Boots.
- Respiratory masks.
- Salvage drums and containment pallets.
- Sandbags or bags of other absorbent materials.
- Danger tape.
- Safety cones.
- Helmet/ "hard hat".
- Face shield.
- Chemical resistant aprons.
- Emergency response guidelines.

## **Fuel Dispensing**

The type of fuel dispenser required depends on the location, functionality and overall needs of the operation. Ideally, any fuel dispenser in use will have access control and a calibrated counter that records fuel dispensed over time.

Additionally, the quality of the fuel will also guide how fuel will be dispensed to users. Fuel from unknown or low quality sources will often come with debris or sediment, or the mixture itself may be impure. If pumping low quality fuel, then users may require a filter (screen or cloth) as fuel comes out of the pump. Other general rules:

- Avoid pumping from the bottom of the container as sediment or debris may build up.
- Avoid also pumping from above the first 10 cm on the top of the tank.
- Avoid dispensing fuel until more than 24 hours after it is delivered – fuel in transit can become well mixed, and the fuel needs time for the debris to settle to the bottom.
- Pumps or dispenser systems must NEVER draw directly from the bottom of a tank. Outflows from tanks should be at least 1/10 from the bottom of the total height to avoid sediment from clogging the pipes/tubes/pumps.

## **Hand Pumps**

There are multiple types of handpumps, however they all follow the same logic; the pump is manually inserted into the fuel container, and fuel is drawn by mechanical hand motion. Hand pumps are useful when:

- Operating in emergency contexts with no other form of power.
- When dispensing fuel from a mobile platform (drums of fuel on the back of a truck).
- Dispensing fuel from small containers or when used relatively infrequently.



Hand pumps don't always have the ability to give a readout of flow, meaning persons using the hand pumps must find alternate ways of tracking and recoding the volume of fuel dispensed. One method is to pump fuel into standardized containers of known size (example: 20 Litre jerrycan). As quantities are dispensed, dispensers should also record outflow in a long book or stock card.

## Powered Pumps

Powered fuel pumping options are far more optimal for large scale fuelling operations. Powered pumps can be broken down into two general categories:

- Fuel dispensed directly into vehicles/small containers.
- Fuel pumped between two large storage containers.

### Fuel Transfer Pump

### Vehicle Fuel Dispensers



The process of dispensing fuel directly to vehicles, or dispensed into smaller hand carried containers will benefit greatly from stationary pumping stations. Stationary pumping stations can either be permanently fixed to the ground, or be permanently fixed to the side of a permanent structure. Pumping stations have a few considerations:

- Pumping stations require electricity to work, meaning a break in the availability of

electricity will halt distribution.

- Pumping stations have nozzles that are right sized for vehicle tanks.
- Some pumping stations have “flowmeters” built into them, that continually record volumes dispensed.

Pumping stations ideally should not be attached to or right next to fuel tanks – vehicles moving around and electrical equipment are additional hazards to fuel management. Additionally, a separating wall between tanks and pumps might mitigate risks associated with spills of fuel or fire related incidents. Even with safety precautions, pumping stations will still always be relatively close to fuel tanks, and personnel conduct around a pump station should be the same as any commercial refuelling station – no smoking, no open flames and always pay attention to safety!

Pumps used to convey fuel from one tank to another tank usually high volume, purpose built pumping mechanisms. Delivery trucks meant to fill up revisors or tanks should have their own sub pumps that are either diesel powered, or draw electricity directly from the truck engines.

## **Gravity Fed Distribution**

A gravity fed distribution system works by using gravity to carry fuel relatively short distances. The system works by placing the tank on a platform or elevated position, and feeding fuel from the side of the tank to a lower position using a hose.

The advantages of a gravity fed system include:

- No need for external power to move fuel.
- A flowmeter can easily be installed.

However, the disadvantages of a gravity fed system are:

- Not useful in all locations/space configurations.
- Require specialized setup, and a large tank.
- Not mobile.

Fuel tanks/reservoirs are ideal for gravity fed fuel distribution systems, however proper plans must be made when developing a gravity fed solution.

Tanks used for gravity fed distribution must be at sufficient height. The discharge point of the tank must be at least 50 cm above the highest point of distribution nozzle, however drops of 2-3 meters are recommended to adequately move fuel.

Platforms for elevated tank storage should be adequate for the anticipated weight of the planned storage container (estimate at least 0.85 kg per litre of storage + weight of the tank itself).

Ideally, gravity fed lines will be made of rigid pipes that run directly to the distribution points. Pipes should be clearly marked, and not exposed to hazards. Wherever possible, gravity fed pipes should be run overhead to final destination.

## **Transporting Fuel**

Wherever fuel is transported even relatively short distances, humanitarian organizations should endeavor to transport fuel as safely as possible.

## Road Transport of Fuel

Road transport is by far the most common method of fuel transport that humanitarian agencies will directly manage, and all precautions should be taken to ensure safe management. As a general rule, wherever possible transport and delivery of fuel should be outsourced to a qualified outside company. Self-managed transportation of fuel should ideally only be used when no other option is available, or when only limited quantities of fuel need to be transported.

Liquid fuels can easily move around inside their containers and dangerously shift weight while in transit. In all scenarios, fuel items transported by vehicle should be adequately braced and secured.

### Drums

Transportation of fuel in drums is ideal for transporting relatively small quantities of fuel, or when specialized storage equipment isn't available.

Drums containing fuel should always be properly braced and tied down. Review the [road transportation section](#) of this guide for more information on proper use of tie downs and working load limits.



Full drums should ideally be transported upright, along their flat edge to avoid rolling around while in transit. Avoid double stacking full drums unless there is specialized railing or securing mechanisms in place.

Both the loading and offloading points should be prepared to receive the drums. This includes handling equipment and ramps. If the delivery location does not have any capacity to offload, the vehicle may have to travel with portable materials suitable for making a ramp. Portable materials may include wooden planks, however whatever is used should be capable of supporting the weight of a full drum rolling on/off the bed of a vehicle.

### Bladders

In some circumstances, fuel can be transported using full bladders. Bladders can come in many sizes, and can easily take up the entire bed of a truck.

Any vehicle transporting fuel using a bladder should be capable of carrying the full weight of the load. Large bladders can easily become very heavy, and transporters may not fully anticipate weight requirements.



Fuel bladders on a vehicle should be properly braced and secured, just like any other load. Tie downs need to accommodate the full weight of the fuel, and the bladder itself should be properly rated for use as mobile transport. Consult with the manufacturer before using a bladder for transport purposes.

### **Tanker Trucks**

Tanker trucks are purpose-built vehicles designed to transport liquids, including fuel. Tanker trucks for fuel are usually only owned and operated by private companies. If a humanitarian agency plans on owning and operating its own fuel tanker vehicle, it will need to ensure that the vehicle meets standards for containing/transporting fuel, is registered and legally able to operate in the local context, and that the drivers are fully certified and trained to operate a specialized vehicle. Prior to buying a fuel tanker truck, agencies should consult with a professional vendor, and with local authorities that manage road safety.



### **Road Transport Safety**

Humanitarian agencies may own or operate their own vehicles, or may take a full responsibility in loading, securing and even driving vehicles transporting fuel. Even if regulations don't specifically stipulate them, there are several steps agencies should follow:

- Never ship fuel with any chemicals, combustible items, or other dangerous or reactive substances. If possible, avoid intermixing fuel with anything else in transport.
- Understand the local context – move the vehicle when is safest time of day and along the



safest route.

- Avoid moving vehicles containing fuel through cities and inhabited settlements wherever possible.
- Instruct staff and drivers on proper transport and handling methods.
- Place signs in local languages indicating:
  - Warnings that the vehicle has combustible fuel.
  - Signs should prohibit smoking around the vehicle.

Please consult the [dangerous goods section](#) of this guide for more information transportation of hazardous materials.

## Regulations

National and local regulations regarding the transport of fuel vary from context to context. These regulations might include:

- Specialized licenses or certifications for drivers.
- Limits on the overall volume of fuel that can be transported in different types of vehicles.
- Limitations on roads, routes, and hours of operation.
- The requirement to notify authorities in advance of vehicle movement.
- The need for specialized signage and placarding to mark vehicles.

Humanitarian agencies will need to speak with local police and local authorities to fully understand requirements.

*Example markings on the back for a tanker truck:*



## Air Transport of Fuel

The transport of fuel using aircraft is highly regulated. International aviation safety standards strictly limit types, quantities, packaging and marking of fuel for different types of aircraft. Some aircraft – such as passenger aircraft – may specifically completely prohibit the transport of fuel as cargo.

Prior to sending any fuel – liquid or compressed gas – by air cargo, humanitarian agencies should consult with the airline and/or the forwarder organizing the shipment.

- All fuel items should be clearly marked, indicating the [UN ID number and having the](#)

[appropriate label marking](#).

- Packages containing fuel should have the appropriate package size/overpacking requirements.
- Fuel items for shipment should be segregated from the rest of the cargo, or on the outside/top of a pallet for easy identification by loaders.
- Proper [shippers' declaration of dangerous goods and material safety data sheets](#) should be supplied.

Under no circumstances should humanitarian agencies attempt to ship fuel without notifying the airline/forwarder in advance. Serious injury or death may occur from unmarked or unidentified fuels in air cargo, and individuals and agencies can be subject to fines or jail time for failing to disclose fuel.

## Other Modes of Transport

The requirements around transporting fuel through other means varies from context to context.

- Sea transport of fuel is feasible, however unlikely that fuel would be transported in small quantities. For organizing fuel using commercial transport, agencies should consult forwarders and follow all [documentation guidelines](#).
- Transporting fuel using river barge is common and largely considered safe. Agencies should consult with the transport provider for proper procedures for packaging and loading.
- Use of smaller boats or pack animals to transport fuel is also acceptable, however all precautions for securing, weight and overall handling should be followed at all times.

## Quality Assurance of Fuel

### Purchasing Fuel

Fuel impurities often start at the level of the supplier. After an emergency, or in less developed markets, pure quality fuel may be difficult to come by, and agencies must take active steps to ensure that they monitor and prevent fuel purity problems from impacting their operations. Inappropriate or impure fuel in particular can damage vehicles and generators, costing significantly more money in the long run.

Some fuel impurities might include:

- Mixing of liquid fuel and water – this may be accidental or intentional on behalf of sellers to increase profits.
- Dirt and organic mater.
- Intermixing of different fuel types (example: petrol and diesel).

Agencies should monitor fuel as it's delivered and conduct their own purity checks. Ongoing issues with purity may indicate fraud, or at least will point out unreliable or poor quality suppliers. Any problems identified with purchased fuel must be recorded and actions should be taken against suppliers that provide poor quality fuel.

When purchasing fuel in drums, each container should be opened and checked with a no-spark measuring stick. If available and required, inspectors should also use "water detecting paste" – when applied to a measuring stick, water detecting paste changes color when it comes into contact with water, and is a useful way to identify impure mixtures early on.

## Filtration/Settling

Impurities in liquid fuel and intermixtures of different types of fuel can be addressed through the process of letting the fuel settle.

- **Debris** - Organic debris, rust, fuel byproducts and other solid contaminants are usually heavier than liquid fuel, and will eventually sink to the bottom.
- **Phase separation** - Liquid impurities, such as water and other fuel components are different densities, and will eventually separate themselves into distinct layers through a process called phase separation.

Once liquid fuel has been delivered to a storage location, it is advisable to let the fuel settle for a minimum of 3 days before using it. This will allow sediment to fall to the bottom, while also allowing for different compounds to separate. If fueling from a drum, never move the drum just before withdrawing fuel.

A quick method for identifying impurities on the spot is to fill a glass jar or transparent jerry can with samples from the liquid fuel. After drawing sample fuel from the bottom of the container, place the clear full container in a shaded location and let it sit for 30 minutes, making sure to not disturb or move the container in any way. A full separation of different impurities including water will take several hours, but observers will still be able to identify problems early on.

If there is an ongoing issue with the quality of fuel as it arrives, then agencies may wish to invest in a separate settling tank system. This includes placing fuel in a dedicated settling tank that is only used to monitor and remove impurities before being pumped into other longer term storage tanks.

When pumping liquid fuel, never pump the last 10 % of fuel in a tank. As water is heavier than diesel fuel, and water and most of the impurities will also go to the bottom of the tank. The remaining fuel in the tank must be filtered with care or used in the workshop for cleaning or other purpose.

When pumping fuel between two containers, it's advisable to use a mesh filter of some kind. Drums secured and delivered in remote locations can still accumulate debris inside, even after settling. It's also advisable to use a water retention funnel when pumping directly into a vehicle. Even fuel has been properly stored and settled, water can still build up inside containers from condensation, and excess water in fuel can damage engines of vehicles.

## Ongoing Quality Assurance

It is strongly advisable to use only dedicated pieces of equipment to each type of fuel. Never use the same pumping tools (pump, filter, funnels, etc...) for different fuels as this may lead to intermixing and impurities. These dedicated items must also always be kept clean and dust free.

Tanks will also need to be periodically emptied and cleaned. The frequency of needing to clean tanks depends on the purity quality of the fuel itself. A general rule is tanks should be cleaned every 2-5 years, or more frequently if required. Cleaning of tanks can be facilitated by having two tanks of identical capacity - simply emptying one tank into the other for the duration of the cleaning.

When cleaning a fuel tank, persons should use proper protective gear:

- Gloves
- Respirator mask
- Protective goggles
- Adequate and safe clothing

The cleaning process includes:

- Allowing all fumes to escape after all fuel has been removed - open the lid to the tank and leave open for at least 24 hours.
- Removing excess debris or grime using a shovel.
- Scrubbing the interior of the tank with steel brush or steel wool.
- Ideally cleaning can occur using only hot water, but cleaning solvents can be used as long as they are completely washed from the tank at the end.
- Once debris has been removed, the tank must be let to thoroughly dry.
- All debris from the tank must be disposed of in a safe and ecologically friendly manner.

## Shelf Life

Liquid fuels degrade and go “stale”. There is no predetermined rate for fuel expiration because there are multiple factors that lead to the degradation of fuel:

- **Hydrolysis** – Fuels exposed to water over a long period of time began to chemically break down.
- **Microbes** – Microorganisms can live in liquid fuels in certain conditions, and will reproduce rapidly, eventually breaking down the fuel.
- **Oxidation** – Excessive exposure to oxygen produces acids as a byproduct.

In all forms of degradation, the result is liquid fuel turning into sludge or a gummy compound that can no longer be used and can damage engines. Excessive exposure to temperatures above 30 degrees centigrade will make the degradation process even faster.

Though there is no specific shelf life, the general rule to follow is:

Fuel Type	Shelf Life Duration
Petrol	6 Months
Diesel	6-12 Months
Jet Fuel	6-12 Months
Kerosene	12 Months (if delivered by pumping) – 5 years (if in original unsealed container)
Propane	5 Years+ (also depends on how long the sealed container can last)

In reality, agencies should only purchase and store as much fuel as they plan on using in the next 3-6 months wherever possible. Excessive fuel stored on site can be dangerous and attract

thieves.

## Accounting

Fuel should be accounted for just like any stored item. There should be logbooks or stock cards that capture the inflow-outflow of fuel, including quantities, dates, intended use and persons involved in the transaction.

Because most fuel is delivered in liquid form, it can be challenging to properly measure consumption. There are a few strategies for proper accounting for liquid fuels:

Strategy	Example
<b>Only dispense into containers of known sizes</b>	Pump fuel into a completely empty 20 litre jerrycan, and record the deduction from stock as 20 litres.
<b>Use equipment with flowmeters where possible.</b>	Some hand cranks and powered pumps come with flowmeters - instruments that measure flow through a hose over the duration of the pumping. Use the reading as the number of litres deducted from stock.
<b>Measure empty space in before pumping</b>	If delivering fuel from a tanker truck or other delivery mechanism, and fuel is being delivered to a tank that is not empty, use a measuring stick to determine the volume first, then fill the tank to 100% full. Record the difference between the two numbers as deducted from stock.
<b>Only dispense full containers</b>	When handing out fuel, only dispense full 200 litre drums or full canisters of compressed gas, and record the deduction from stock. This method only works for some operations at scale however.

It is very important to remember that fuel contracts noticeably with temperature decreases, and that fuel itself can evaporate. There may be variations in the long run that make perfect accounting impossible. Best practice tips for tracking fuel include:

- Keep lids to fuel containers tightly sealed when not in use.
- Record the outside temperature on the stock card when fuel is first delivered and try to measure levels at or around the same temperature.
- With seasonal changes, expect a 2.5% +/- in overall volume as an acceptable variance. Fuel delivered in cold weather may appear as gaining volume while fuel delivered in hot weather may lose volume.

## Dangerous Goods

*“ Articles or substances which are capable of posing a hazard to health, safety, property or*

the environment. ([ICAO](#))

Dangerous Goods, frequently referred to as "DG" for short, are commonly handled by humanitarian organisations in field settings. Unfortunately, proper handling and storage of DG items is less commonly known, and many areas of humanitarian response lack regulatory oversight or enforcement of DG rules. Humanitarian actors should attempt to learn as much about DG items under their care for the safety of their own personnel, local communities, and the environment, and should seek to enforce proper handling and storage procedures wherever DG may be present.

## Common Terms in Dangerous Goods

<b>DG</b>	Short for "Dangerous Goods" – the term "DG" is used frequently in international transportation and storage.
<b>Flash point</b>	The lowest temperature at which flammable liquid ignited in the atmosphere when exposed to a source of ignition.
<b>Explosive article</b>	Any article containing one or more explosive substances.
<b>Overpack</b>	An enclosure used by a single shipper to contain one or more packages and to form one handling unit.
<b>Outer Packaging</b>	The outer protection of a composite or combination packaging together with any absorbent materials, cushioning and any other components necessary to contain and protect inner receptacles or inner packaging.
<b>Pressurized Containers</b>	Any container or vestibule that contains pressurised liquids or gasses of any kind. Pressurised containers can be considered dangerous goods even when evacuated and empty.
<b>UN Dangerous Goods Identification Number</b>	Four-digit ID number that quickly identifies the specific dangerous good and any associated handling or special transportation needs.

---

<b>ICAO</b>	Short for the United Nations “International Civil Aviation Organisation”.
<b>IATA</b>	Short for “International Air Transport Association.”
<b>HazDec</b>	Short for “Shipper’s Declaration of Dangerous Goods.” HazDecs are predefined declaration forms shippers must include when transporting DG items via air/sea.
<b>IMO</b>	Short for “International Maritime Organisation”
<b>DGD</b>	Short for “Shipper’s Dangerous Goods Declaration.” DGDs are predefined declaration forms shippers must include when transporting DG by air/sea.
<b>HazMat</b>	Short for “Hazardous Material,” used in reference to DG, most commonly in North America.
<b>Reactive Substance</b>	Any substance that may react to other specific substances nearby, especially when exposed to air, when improperly stored, or when the required storage container is compromised. Reactive substances may cause rapid energetic reactions, or slow reactions. Many reactive substances react strongly to other specific substances, such as water or other chemicals, and must be handled accordingly.

---

## **Hazardous Materials and Dangerous Goods Types**

Since 1956, the United Nations Committee of Experts on the Transport of Dangerous Goods has compiled, maintained and updated what are known as *UN Recommendations on the Transport of Dangerous Goods* ([UN Model Regulations Rev. 12, 2001](#)). These official recommendations include suggested standards on categorisation, labelling, and harmonised numbering of DG items for quick reference. These official recommendations are not binding - local regulations can choose to adopt, enhance or exclude regulations - and technically only pertain to transportation. Irrespective of the voluntary or specific nature of the guidelines, many international agencies have opted to adopt these standards and nomenclatures for daily use.

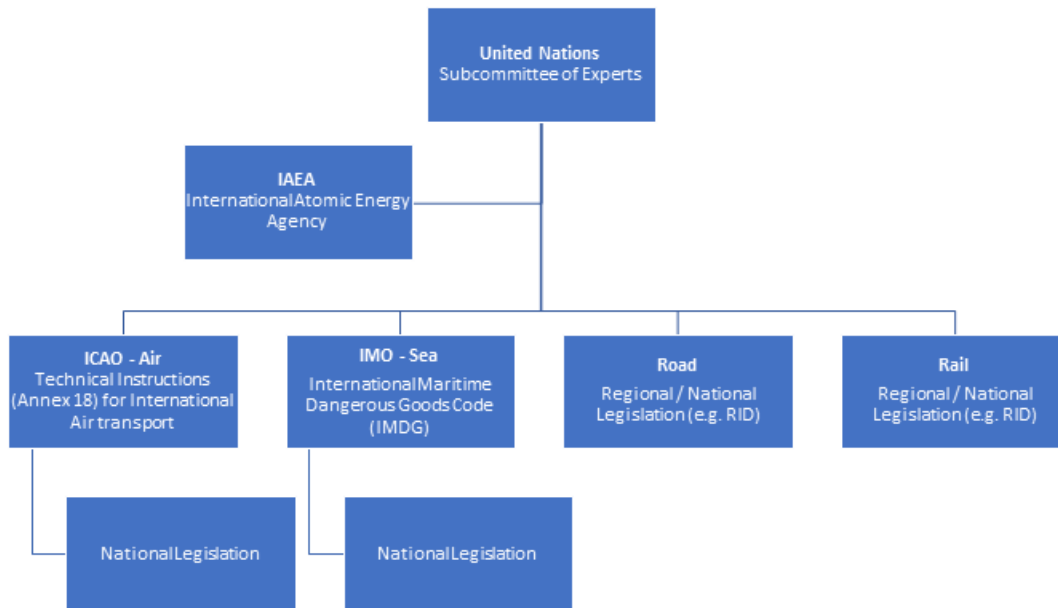

As part of the *UN Recommendations on the Transport of Dangerous Goods*, the United Nations Committee of Experts on the Transport of Dangerous Goods maintains what is called a "[Dangerous Goods List](#)," a consolidated and updated list of commonly transported DG items. The Dangerous Goods List serves as a quick reference tool for persons associated with the transport and handling of DG.











The overall types and number of DG handled by transporters and warehouse personnel can be vast. Different industries have a wide variety of material requirements, and suppliers and manufacturers tend to develop specialised expertise in specific areas of DG. Irrespective of the industry specifics, handlers of DG should have a general understanding of how to manage all potentially hazardous materials they may encounter.











## Hazard Class

When it comes to handling and managing DG, there are agreed upon categories of materials/substances that are commonly used between manufacturers and logistics providers, referred to by pre-defined corresponding classes. A table of these common categories and corresponding classes and sub divisions can be seen below.

Class	Category	Label	Example
	1.1 Mass explosion hazard		Demolition
	1.2 Projection hazard but not a mass explosion hazard		Fireworks



Class	Category	Label	Example	
<b>1</b> <b>Explosives</b>	1.3 Fire hazard and either a minor blast hazard or a minor projection hazard or both, but not a mass explosion hazard		Flares	
	1.4 No significant blast hazard		Safety Devices	
	1.5 Insensitive explosives with a mass explosion hazard		Blasting Agent	
	1.6 Extremely insensitive articles which do not have a mass explosion hazard		Explosive Extremely Insensitive Article	
	<b>2</b> <b>Gases</b>	2.1 Flammable gases		Butane, Propane
		2.2 Non-flammable, non-toxic gases		Argon, Oxygen
2.3 Toxic gases			Insecticide, Pesticide Gas	
<b>3</b>	<b>Flammable Liquids</b>		Diesel, Alcohol	
	4.1 Flammable solids, self-reactive substances and solid desensitised explosives		Sulphur, Safety Matches	
	4.2 Substances liable to spontaneous combustion		White or Yellow Phosphorus	
<b>4</b> <b>Other Flammable Substances</b>	4.3 Substances which in contact with water emit flammable gases		Lithium	

Class	Category	Label	Example
<b>5</b>  <b>Oxidizing Substances and Organic Peroxides</b>	5.1 Oxidizing substances		Calcium Chlorate, Oxygen Generator
	5.2 Organic peroxides		Hydrogen Peroxide
<b>6</b>  <b>Toxic (Poisonous) Substances</b>	6.1 Toxic substances		Pesticides
	6.2 Infectious substances		Patient Specimens
<b>7</b>	<b>Radioactive Materials</b>	  	Machine components, Radioactive isotope for diagnosis or treatments
<b>8</b>	<b>Corrosives</b>		Acids
<b>9</b>	<b>Miscellaneous Hazardous Materials</b>	 	First aid kit, Lithium Batteries

Some hazard classes – such as radioactive materials – may be extremely rare for most humanitarian organisations – but most humanitarian response organisations will handle a variety of different DG items throughout the course of their supply chains.

Some DG items have more than one hazard class, having what is known as a “subsidiary hazard

class” – the secondary (or more) set of hazards that define the DG item. As an example, an explosive substance may also be toxic, or a gas may also be corrosive. The leading primary hazard classes and subsidiary hazard classes are identifiable by referencing the substance in the Dangerous Goods List. The classification is universal across multiple modes of transport.

Such hazard classes and their respective labels provide quick and visual indication of all hazards posed by the article or substance. Direct recognition of all hazards, makes it easy to understand the risks, apply segregation (incompatibility) guidelines and ensure everyone is aware they are dealing with DG.

UN No.	Name and description	Class or division	Subsidiary hazard	UN packing group	Special provisions	Limited and excepted quantities		Packagings and IBCs		Portable tanks and bulk containers	
						(7a)	(7b)	Packing instruction	Special packing provisions	Instructions	Special provisions
(1)	(2)	(3)	(4)	(5)	(6)	(7a)	(7b)	(8)	(9)	(10)	(11)
-	3.1.2	2.0	2.0	2.0.1.3	3.3	3.4	3.5	4.1.4	4.1.4	4.2.5 / 4.3.2	4.2.5
124	METHYL PROPYL KETONE	3		II		1 L	E2	P001 IBC02		T4	TP1
1250	METHYLTRICHLOROETHANE	3	8	II		0	E0	P010		T10	TP2 TP7 TP13

## UN DG Numbering System

Contained within the Dangerous Goods List is a consolidated numbering system for the rapid classification of dangerous goods. This list is sometimes referred to as the UN Dangerous Goods Identification Number, Dangerous Goods Classification Number, or Sometimes just the UN Number.

This UN number is universal across multiple modes of transport, and consists of four digits

Example:

**Item Description** Calcium hypochlorite mixture, dry, corrosive with more than 10% but not more than 39% available chlorine

**UN ID Number** UN 3486

Understanding and utilising UN DG numbers is extremely important for anyone planning on procuring, transporting and storing any substance that might be considered dangerous goods. DG numbers are extremely specific to material or chemical composition, and referencing a DG number across the Dangerous Goods List will quickly inform handlers of labelling requirements, packing instructions and limits for different forms of transport, hazard class, special handling needs, and if there are potential secondary hazards such as reacting to other substances.

To enhance the safe handling and transport of goods, users must correctly and accurately identify the UN Number. UN Numbers can be found on the Dangerous Goods List in the first column next to the corresponding DG item. The UN DG number is extremely specific, and many

DG items with similar sounding names might have different ID numbers. When determining the ID number, users must use the accurate, full name of the DG item, and may even need to denote the percentages of its chemical composition or even the size of its packaging.

UN No.	Name and description	Class or division	Subsidiary hazard	UN packing group	Special provisions	Limited and excepted quantities		Packagings and IBCs		Portable tanks and bulk containers	
						(7a)	(7b)	Packing instruction	Special packing provisions	Instructions	Special provisions
(1)	(2)	(3)	(4)	(5)	(6)	(7a)	(7b)	(8)	(9)	(10)	(11)
-	3.1.2	2.0	2.0	2.0.1.3	3.3	3.4	3.5	4.1.4	4.1.4	4.2.5 / 4.3.2	4.2.5
1817	PYROSULPHURYL CHLORIDE	8		II		1 L	E2	P001 IBC02		T8	TP2
1818	SILICON TETRACHLORIDE	8		II		0	E0	P010		T10	TP2 TP7

Transporters will rely on this information for the process of properly securing and handling loads, especially air transporters who may be adversely impacted by DG items. If the UN DG Number is unknown, or isn't readily available, persons involved with the transportation or storage of DG items should not make up a number nor search in the inappropriate places. Wherever possible, logistics personnel should consult with manufactures, properly certified persons, or transport providers to properly identify the correct numbers.

## Marking and Labelling

In the context of DG handling, labelling refers to the proper placement of pre-defined labels on the carton, canister, or other form of packaging or overpacking that dangerous good or hazardous items are stored and transported in. The labelling of DG is absolutely essential for air transport, however DG container should be labelled at all points throughout the supply chain, including warehousing and all other forms of transportation.

- Any person or organisation shipping or handling dangerous goods for any reason should be able to clearly identify DG using the appropriate labelling.
- The hazardous material contained within the packaging defines the labelling required.
- Labelling should be easy to read and clearly visible on the outermost outer packing or overpacking, and should be affixed on the side/top of the carton, ideally near the shipping label.
- Mixed or consolidated packages of more than one type of hazardous material must contain proper labelling for each type of dangerous goods. NEVER mix or consolidate hazardous materials into a single package that might react with each other in any way.
- For storage: If at all possible, cartons containing DG should be stored in a manner that makes them easy to access and identify, meaning that the labels should remain visible at all times.
- For transport: If DG containers are palletised, pallets containing DG items should also be clearly labelled on the outside of the pallet wrapping or binding.
- For transport: Each label type must meet the size and colour requirements defined by ICAO and IATA, IMO, or other regulatory body relevant to the mode of transportation.

**UN Number** – Cartons or containers used for transporting DG items should clearly indicate the correct corresponding UN number.

**Hazard Class Labelling** – Containers of DG of any kind should be clearly labelled with the corresponding hazard class label. Hazard class labels should not be smaller than 10 cm along the edge. If a container has more than one DG hazard class, each hazard class must be indicated on the outside. Containers with DG that have one or more subsidiary hazard class must also be clearly labelled each subsidiary hazard class on the outside. The colour and

symbol of the hazard label, indicates the type of hazard (e.g. red for fire, skull and bones for toxic).

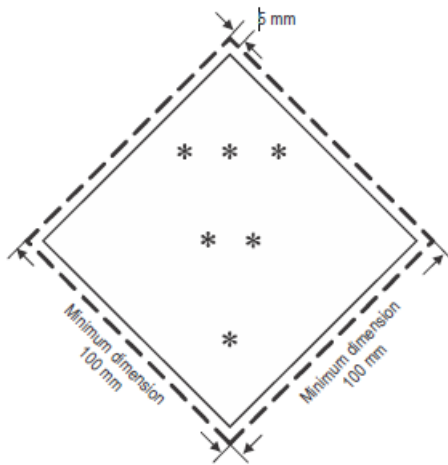

Example Hazard Class Labels:



**Handling Labels** – Handling labels should be used in conjunction with hazard class labels, but provide specific information specific to the DG that cannot be ascertained from the hazard class alone. This might include package orientation, special handling needs, or special considerations.

Example Handling Labels:



Note: the example labels serve as a guide only. Hazard labels have variations to express even more information, and there are even a wider set of handling labels. Both label types are routinely reviewed and updated by international regulatory bodies. For the most up to date set of labels, please coordinate with a properly certified person or transporter.

### Example Carton with DG Marking



## Placarding

A placard is a physical sign that denotes a large physical structure that either contains or transports one or more containers of DG items. Physical structures might include:

- Bulk packaging.
- Freight/Cargo container.
- Unit load device (ULD).
- Truck, rail car, or other surface vehicle transporting DG.
- Warehouse (area).

A placard functions much like a sticker label – it denotes the hazard class and specific attributes of the DG contained within vehicle or structure.

The use of placards is not universally regulated nor is it universally enforced, especially as it pertains to use inside of individual countries of operation. Many countries heavily regulate the use of placards on locations that store DG items, or on vehicles that transport DG items, while other countries have limited to no regulation, especially in humanitarian contexts. Persons or organisations operating in any country should understand local regulations surrounding placard usage, and should utilise the appropriate placard where available.

Vehicles or multi-modal containers that may cross international boundaries may be required by one or both countries to properly place placards on vehicles or containers,. Shipping containers that contain DG that frequently are transhipped between various ports are usually required to have some form of placarding, commensurate with port and private regulations.

In contexts where placard use is not regulated or enforced, humanitarian agencies should endeavour to still place placards where safe and appropriate. There is no one accepted guidance on placard usage, but as a general rule, any time the cumulative aggregate weight of DG on any one vehicle exceeds 500 kg, then vehicles should be properly marked. Additionally, long term storage locations containing DG should also be clearly placarded.

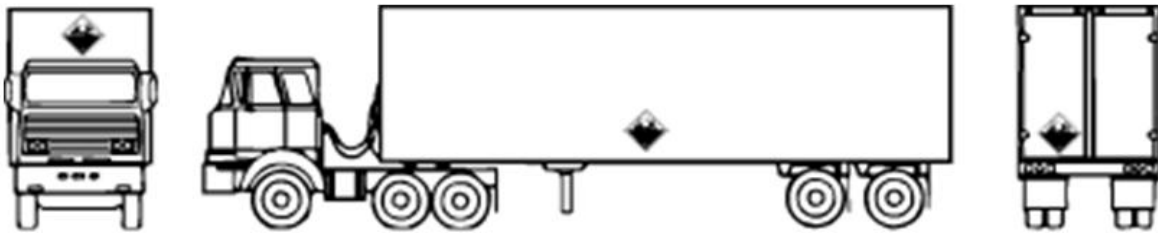

Title

Download - DG Hazard Labels

File



## Common Issues with Storage and Transport of Dangerous Goods

### Any Form of Multi-Modal Transport

Irrespective of form of transport, there are certain DG considerations all shippers including humanitarian agencies should be aware of.

#### Differing Standards

Though there is wide consensus on how to handle and process DG cargo, not all standards across all modes of transport are the same. The overall size or type of packaging for a DG item may vary depending on the mode of transport. As an example, a container of Calcium

Hypochlorite (HTH) might be allowable up to 20 kg per container for a seaborne vessel while only allowed up to 5 kg for an airborne vessel. Additionally, there are different declaration and labelling standards for different modes of transport. Humanitarian supply chain planners should think through their entire supply chain needs when deciding what DG to procure and how to properly package and label it, taking multiple modes of transport into account.

## **Responsibility**

The legal requirements for compliance with DG regulations vary greatly across operational contexts – commercial aviation will have strict regulations while field level operations may have no discernible regulations at all. This variation may cause problems throughout a supply chain – persons ordering or packing cargo at one end of the supply chain may not understand the requirements for another part. Humanitarian actors must still know what DG items they intend to handle, and know how to handle them. As DG items are stored and transported they will need to be properly labelled, packaged, identified on packing lists/manifests and have the appropriate accompanying declaration documentation. In highly regulated contexts, any failure to identify or properly classify a DG item can result in fines, cargo being rejected or impounded, or contractual penalties. Serious incidents resulting from mislabelled or misidentified DC can result in series legal penalties or jail time. In any context, incorrectly packed or handled dangerous goods can have on operations safety, in worst case scenario a spill, fire can result from incorrect shipment preparation or handling, with dramatic consequences for people and assets.

## **Certification in DG Handling/Shipping**

Private industries – such as international aviation and maritime associations – and some national or local regulatory bodies rely on specially trained persons or third-party experts to properly identify and manage the labelling, handling and transport requirements for DG. A properly DG certified person will have undergone specific training from relevant accredited bodies, and may have to undergo re-certification every year. The different levels and types of certification relate to the nature of the DG activity (air, sea, road, etc) and to the overarching bodies that govern the type of activity. Where possible, humanitarian agencies should work with accredited transport companies, forwarders, and local government authorities. Regulations in many parts of the world require certified persons to prepare and inspect DG items before they can even be loaded onto a vessel in the first place.

As an example, DG shipped using international commercial air transport must be managed by a person certified through an IATA recognised DG training program; the properly IATA DG certified person is ultimately responsible for signing all DG related declarations. Any person who is not certified to manage air transport of DG should not be certifying DG cargo, and failure to comply can result in accidents and penalties. Different regulatory bodies may require different forms of certification, and national and local laws may require DG certification for warehousing, sea and road transport supervision as well.

Humanitarian agencies may not have the capacity to employ full time personnel with all required certifications, but third-party logistics companies often can and do have properly certified persons on call who will work with agencies to properly document and certify DG cargo. To facilitate this process, humanitarian agencies may seek as much information on DG related products as possible. Manufacturers and vendors in more developed industries can supply DG related information, including:

- Special temperature or handling requirements.
- Local and international regulations.



- Specifications on packaging requirements for shipping.

## Safety Data Sheets

Many suppliers should be able to provide what is known as a Safety Data Sheet (SDS) / Material Safety Data Sheet (MSDS) / Product Safety Data Sheet (PSDS) – product specification sheets that can inform commercial handlers and transporters of any DG related properties to assist the transport process. Many transporters – especially air transporters – will ask for SDS/MSDS/PSDS to be submitted along with other documentation.

# SAFETY DATA SHEET

## SECTION 1: IDENTIFICATION

### 1.1 Product Identifier

**Product Form:** Substance

**Product Name:** Natural Gas

**Synonyms:** Methane

### 1.2 Intended Use of the Product

Fuel gas - domestic, commercial and industrial

Note: this Safety Data Sheet does not include information related to Liquefied Natural Gas.

### 1.3 Supplier Information

Supplier Name

Address

Country

Phone Number

### 1.4 Emergency Telephone Number

**Emergency Number** : 1-877-969-0999

## SECTION 2: HAZARD IDENTIFICATION

### 2.1 Classification of the Substance or Mixture

Simple Asphyxiant	Simple Asphyxiants – Category 1; A gas that is a simple asphyxiant.
Gases Under Pressure	Gases under pressure / Compressed gas
Flam Gas 1	Flammable gases - Category 1
H220	Extremely flammable gas
H280	Contains gas under pressure; may explode if heated

### 2.2 Label Elements

**Hazard Pictograms**



**Signal Word**

: Danger

**Hazard Statements**

: H220 - Extremely flammable gas.  
H280 - Contains gas under pressure; may explode if heated.  
H380 - May displace oxygen and cause rapid suffocation.

**Precautionary Statements**

: P210 - Keep away from heat, sparks, open flames, hot surfaces. No smoking.  
P377 - Leaking gas fire: Do not extinguish, unless leak can be stopped safely.  
P381 - Eliminate all ignition sources if safe to do so.  
P403 - Store in a well-ventilated place.  
P410+P403 - Protect from sunlight. Store in a well-ventilated place.

### 2.3 Other Hazards

Exposure may aggravate those with pre-existing eye, skin, or respiratory conditions. Asphyxiant gas, can be fatal. May cause damage to the blood, central nervous system, and cardiovascular system. High concentrations of gas can cause unconsciousness and death. Mercaptan is added (rotten egg odour) to the gas, however this smell should not be relied on as a good indicator of the presence of gas as olfactory fatigue (loss of smell) occurs rapidly. Being under the influence of alcohol may enhance the effects of this product.

## SECTION 3: COMPOSITION/INFORMATION ON INGREDIENTS

Name	Product Identifier	% (w/w)	GHS / WHMIS Classification
Natural gas (predominantly methane)	(CAS No) 8006-14-2	100	Simple Asphyxiant Flam. Gas 1, H220 Compressed gas, H280

# Air Transport of Dangerous Goods

Out of all methods of cargo transport, air transport is by far the most sensitive to proper DG packaging, labelling and handling. Operating and maintaining an aircraft at altitude is already a dangerous task, and small problems that might arise from any DG item being mishandled can be amplified to catastrophic proportions very quickly.

- The air inside aircraft is rapidly recirculated, and any potentially hazardous fumes or smoke can harm crew members quickly.
- Fires spread quickly inside aircraft, and crews have limited space and reaction times.
- Energetic explosive events, or projectile objects can harm essential crew or depressurise a cabin causing serious or fatal accidents.

The majority of commercially operated aircraft take guidance from both the International Air Transport Association (IATA) and the International Civil Aviation Organisation (ICAO)

**IATA** - IATA is an international consortium of governments and private sector operators that helps define mutually recognised regulations and standards for international transportation of goods and persons, including regulations relating to the transportation of dangerous goods. Many national civil aviation authorities follow IATA guidelines, and virtually all international air operators and international airports follow IATA standards.

**ICAO** - ICAO is a specialised UN agency that supports the development of mutually recognised civil aviation standards among UN member states, including air safety regulations.

ICAO and IATA collaborate closely on the development and provision of DG regulations which are considered industry standards. IATA publishes the “Dangerous Goods Regulations” (DGR) while ICAO publishes “Technical Instructions for the Safe Transport of Dangerous Goods by Air,” both of which are updated on an ongoing basis. These regulations don’t just designate labelling and handling, but also denote quantity limitations, specialised packaging requirements for air transport, what cargo may not travel on passenger aircraft, and restrict some DG items altogether.

Virtually all commercial and private flights that operate internationally must comply with IATA and ICAO standards, including those standards relating to DG. Commercial shippers, manufacturers, suppliers, airports and ground handling companies should understand these regulations, and have a shared common understanding of how DG should be transported by air. Aircraft that operate in domestic airspace and do not cross an international border are beholden to that country’s civil aviation authority (CAA). Domestic CAAs have the autonomy to operate and regulate aviation activity within their own airspace as they see fit, however most CAAs align their standards closely with both ICAO and IATA. Furthermore, a common adoption of international DG standards makes it easier for pilots and crew to operate multiple countries when required.

DG transported by air will be highly scrutinised by airports, CAA authorities, aircraft operators, crew and insurance companies. The ultimate determining factor of what can or cannot be loaded onto an aircraft is the loadmaster, crew and pilot, who will follow local and international standards, and assess what they feel as safe. Loaders will still expect DG cargo to be properly packaged and declared, that SDS/MSDS/PSDS are provided and DG marked on packing lists, and that persons or organisations who plan to ship DG items by air should identify and work with companies and logistics providers who are fully certified and authorised to manage, label and handle DG items.

## **Shipper's Declaration for Dangerous Goods**

The "Shippers Declaration of Hazardous Goods" (abbreviated as DGD and also known as Hazardous Declaration or HazDec) is a standard, industry wide accepted form for properly declaring dangerous goods as they are loaded onto an aircraft. DGDs should be submitted with regular paperwork – such as a packing list – as well as being stored alongside the DG cargo itself. Air operators, airports, ground handling crews and insurance underwriters rely on DGDs to quickly identify all potential hazards and understand how to assess incoming consignments. Consequently, the person filling out and signing a DGD should be properly certified by an ICAO or IATA accredited certification program in DG. Many air operators in developed contexts will only accept DGDs from certified persons. Falsely declared or improper certification on a DGDs can lead to serious penalties.

SHIPPER'S DECLARATION FOR DANGEROUS GOODS



Shipper		Air Waybill No.								
		Page of Pages								
		Shipper's Reference No. (optional)								
Consignee										
Two completed and signed copies of this Declaration must be handed to the operator.		<b>WARNING</b>								
<p><b>TRANSPORT DETAILS</b></p> <p>This shipment is within the limitations prescribed for:</p> <p>(delete non-applicable)</p> <table border="1"> <tr> <td>PASSENGER AND CARGO AIRCRAFT</td> <td>CARGO AIRCRAFT ONLY</td> </tr> </table> <p>Airport of Departure (optional):</p> <p>Airport of Destination (optional):</p>		PASSENGER AND CARGO AIRCRAFT	CARGO AIRCRAFT ONLY	<p>Failure to comply in all respects with the applicable Dangerous Goods Regulations may be in breach of the applicable law, subject to legal penalties.</p> <p>Shipment type: (delete non-applicable)</p> <table border="1"> <tr> <td>NON-RADIOACTIVE</td> <td>RADIOACTIVE</td> </tr> </table>					NON-RADIOACTIVE	RADIOACTIVE
PASSENGER AND CARGO AIRCRAFT	CARGO AIRCRAFT ONLY									
NON-RADIOACTIVE	RADIOACTIVE									
<b>NATURE AND QUANTITY OF DANGEROUS GOODS</b>										
<b>Dangerous Goods Identification</b>										
UN or ID No.	Proper Shipping Name	Class or Division (subsidiary hazard)	Packing Group	Quantity and Type of Packing	Packing Inst.	Authorization				
Additional Handling Information										
I hereby declare that the contents of this consignment are fully and accurately described above by the proper shipping name, and are classified, packaged, marked and labelled/placarded, and are in all respects in proper condition for transport according to applicable international and national governmental regulations. I declare that all of the applicable air transport requirements have been met.				Name of Signatory						
				Date						
				Signature (See warning above)						

## Sea Transport of Dangerous Goods

Sea transport also some specific sensitivities pertaining to the transport of DG. Though not as strict as aviation, seaborne cargo comes with its own special restrictions and considerations, as well as its own handling needs. Additionally, the majority of seaborne cargo by nature moves between different ports in different countries, necessitating a strong common international standard.

- DG transported in ocean containers can be stored for months a time, and be exposed to a wide range of temperatures.

- Shipping containers can be transhipped through multiple ports globally, and may be stored in the vicinity of a wide range of other DG or heavy machinery.
- The quantities of DG that may be stored on a single vessel may be substantial, and can result in large explosive, toxic, or other hazardous accidents. Crews stranded on vessels at sea may be days away from a rescue, and their health and safety may be heavily compromised.

As it pertains to DG, seaborne vessels take their guidance from the International Maritime Organisation (IMO). The IMO is a United Nations specialised agency with responsibility for the safety and security of shipping and the prevention of marine and atmospheric pollution by ships. The IMO produces what is called the International Maritime Dangerous Goods (IMDG) Code. The IMDG Code specifically outlines the storage, handling, labelling and placarding of DG cargo on vessels. IMDG is also update on an ongoing basis.

The vast majority of sea cargo utilised by humanitarian agencies will be transported using multi-modal shipping containers, or perhaps large oversized cargo such as vehicles. It is unlikely that humanitarian agencies will be responsible for sealing their own containers or be present for vessel loading; to ensure DG is properly handled they must work with a knowledgeable and certified person or company who can advise on the proper packing and labelling of cargo, and who will be responsible for ensuring containers contain the appropriate placards. Humanitarian agencies shipping goods will still be expected to provide as much information as possible, including identifying UN DG Identification Numbers, specifying DG on packing lists, SDS/MSDS/PSDS and supplying supporting documentation.

### **Dangerous Goods Declaration (DGD)**

The IMO "Dangerous Goods Declaration" (DGD) is a standard, industry wide accepted form for properly declaring dangerous goods as they are loaded onto a seaborne vessel. DGDs should be submitted with regular paperwork – such as a packing list – as well as being stored alongside the DG cargo itself. DGDs may not be the only dangerous goods declaration forms used by transporters – some shipping lines maintain their own DG declaration standards, especially if they operate using domestic inland waterways. Irrespective of the form used, DGDs must be filled out and signed by someone who is fully authorised and certified to do so.

### IMO DANGEROUS GOODS DECLARATION

This form meets the requirement of SOLAS 74 chapter VII, regulation 5; MARPOL 73/78 ANNEX III, regulation 4 and the IMDG CODE, General introduction, section 9

Shipper	1	Reference number(s)	2
		<b>Page 1 of 1</b> <b>Shipper's Reference Number</b>	
Consignee	3	Carrier:	4
Container packing certificate/vehicle declaration  <b>DECLARATION</b>  It is declared that the packing of the container/vehicle has been carried out in accordance with the General Introduction, IMDG Code, paragraph 5.4.2  <b>TO BE COMPLETED FOR SHIPMENTS IN CONTAINERS OR VEHICLES</b>		Name/status, company/organization of signatory	5
		Place and date	
		Signature on behalf of packer	
Ship's name and voyage No.	Port of loading	Instructions or other matter	7
6			
Port of discharge	8		
Marks .Nos. If applicable, identification or registration number(s) of the Unit	Number and kind of packages, proper shipping name *, IMO hazard class/division, UN number, packaging group (where assigned) **, flashpoint (in °C.c.c.) * *, control and emergency temperatures * *, identification of the good as MARINE POLLUTANT* *, EmS No. and MFAG Table No.***	Gross mass (kg.), net quantity/mass* *	Goods delivered as: <input type="checkbox"/> Breakbulk cargo  <input type="checkbox"/> Unitized cargo  <input type="checkbox"/> Bulk packages  Type of unit (container, trailer, tank vehicle, etc.)  <input type="checkbox"/> Open  <input type="checkbox"/> Closed  Insert "X" in appropriate box  (This column may be left empty apart from the heading, in which case insert appropriate description)
* Synonyms should not be used. Proprietary/trade names alone are not sufficient. If applicable:(1) the word "WASTE" should precede the name (2) "EMPTY UNCLEANED" or "RESIDUE-LAST CONTAINED" should be added (3) "LIMITED QUANTITY" should be added.  ** When required in paragraph 9.3 of the General Introduction to the IMDG code; * * * When required. <b>The IMDG Code page number should not appear on this form.</b>			
<b>ADDITIONAL INFORMATION</b> (In certain circumstances special information/certificates are required, see IMDG code, General Introduction, paragraphs 9.7.1/9.7.2/9.9.1 and 9.10.			10
<b>DECLARATION</b>  I hereby declare that the contents of this consignment are fully and accurately described above by the proper shipping name(s), and are classified, packaged, marked and labeled/placarded, and are in all respects in proper condition for transport according to applicable international and national governmental regulations.		Name/status, company/organization of signatory	11
		Place and Date	
		Signature on behalf of shipper	

## Road Transport of Dangerous Goods

There is no globally recognised standard for the proper method for the surface transport of DG items. National and local regulations vary greatly, and the contexts in which humanitarian organisations may respond might have virtually no regulation whatsoever. Humanitarian organisations should endeavour to maintain minimum safety standards for road transport of DG, and remain in compliance with any regulations that may pertain to the geographic areas of response.

Packaging, Labelling and Identification – to whatever extent possible, DG items transported by road should have proper labels on cartons/containers, and be fully disclosed on shipping documents such as packing lists and waybills. As a rule of thumb, DG labelling and packing should be at least equal to the requirements for sea shipping, however local regulations may strictly indicate these requirements as well. Packaging should not be compromised, and transporters – especially third party transporters – should be made well aware of the contents of their vehicles.

## **Placards and Vehicle Requirements**

Many national and local regulations strictly regulate the placement of placards on surface vehicles that transport DG. These regulations relate not only to the placement of markings, but also to the types/volumes/quantities of DG items, times of day and locations of operation, and even may require special training from drivers or special ratings for vehicles. Humanitarian agencies planning to operate in any context should research and understand these regulations where required. Failure to do so can mean required volumes of items not being able to be delivered, transhipped, or not being able to be transported by regular means altogether.

## **Self-Loaded/Self-Operated Vehicles**

Humanitarian agencies may own or operate their own vehicles, or may take a full responsibility in loading, securing and even driving vehicles laden with DG. Even without official regulation, there are several steps agencies should follow:

- Avoid loading multiple types of DG that may react with each other onto a single vehicle.
- Properly secure DG items that may fall over or spill.
- Never transport DG items long side other items that may cause rapid or violent reactions.
- Avoid overloading any one vehicle with DG – spread DG deliveries out over a long period of time.
- Where large loads of DG items are unavoidable (example: fuel trucks), understand the local context – move the vehicle when is safest time of day and along the safest route.
- Instruct staff and drivers on proper transport and handling methods.
- Transport compressed containers empty were possible, and discharge batteries.
- Where required, place signs in local languages indicating:
  - Warnings when a truck may have flammable or hazardous substances.
  - If people should avoid smoking around the vehicle.
  - If special handling requirements for the DG items exist.

## **Warehousing and Storage of Dangerous Goods**

The proper storage and warehousing procedures for DG items – while extremely important – do not have a well-defined international standard like transportation of DG does. This largely stems from the fact warehouses themselves will almost never operate between two different sovereign territories. As a result, the proper storage of DG in a warehousing context is often regulated by national and local authorities; sometimes regulation is heavy, and sometimes regulation is almost non-existent.

Humanitarian organisations operating in any context should both understand the proper methods of storing DG, and should maintain and enforce internal policies. Additionally, any agency specific warehousing DG procedures should also comply with the prevailing national or local laws regarding DG management.

## Identify DG/Hazardous Items

While in the course of humanitarian operations, persons working in storage or warehousing should always be alert for incoming DG/Hazardous Items. Simple steps to follow for identifying potentially hazardous materials include:

- Check labels on containers for clues such as, caution label, warning label, danger label. These are usually the indication if something is hazardous.
- Check for SDS/MSDS/PSDS for incoming shipments.
- Identify the material on the UN list of dangerous goods.

## Basic DG and Hazardous Materials Handling Requirements

When storing any DG or hazardous materials for any reason and in any context, the following is recommended:

- Identify DG/hazardous materials beforehand and transport, handle, and store them in accordance with local regulations.
- Keep SDS/MSDS/PSDS in the same storage location as the stored DG/hazardous items.
- Learn and know the risk of DG/hazardous items in storage.
- If necessary, keep a separate DG/hazardous inventory.
- Separate and properly track DG/hazardous item waste.
- Keep adequate spill response equipment available and train employees on their use.
- Use the rule of "first in first out" (FIFO), use the oldest product first.
- If the expiration date marked on the side of the product has been exceeded, contact the proper authority to see if the expiration date has been or can be exceeded.

## Spill Prevention

Steps that any person managing DG/hazardous materials can take to reduce or prevent spills might include:

- Understand chemical hazards.
- Follow safe storage and handling procedures.
- Read and follow the instructions on labels and material safety data sheets.
- Don't store or use chemicals in unlabelled containers.
- Inspect chemical containers for damage or leaks.
- Don't handle or open chemical containers without appropriate personnel protective equipment (PPE).
- Don't leave containers open.
- Report potential hazards to managers, other employees, and safety managers.

It is recommended that damaged or leaking hazardous materials should be removed and stored in a separate, safe space. Ideally, spilled items should be stored in a well-marked, reinforced plastic drum.

## Spill Response

In the event of a spill or leaking container, the supervisor of the facility should be notified. The person discovering the spill and the site supervisor should record information on the spill (when it occurred, why it occurred, what was spilled, volume spilled, personnel involved, etc.), and keep on file at the storage location.

Necessary action to contain and control the spill by soaking up, diverting, or containing any



liquid flow should be taken immediately to prevent contamination of any surface drains, soils, or waterways. Such action could include spreading absorbent materials or pads and/or using absorbent rolls or dirt to control the flow.

## **Spill Clean-up**

Materials used to support the clean-up DG/hazardous materials spills should be readily available in all storage locations where DG/hazardous materials might be stored. These materials might include items such as the following:

- Oil absorbent pads.
- Brooms and squeegees.
- Large plastic covered trash bins.
- Nitrile gloves and latex gloves.
- Leather gloves.
- Boots.
- Respiratory masks.
- Salvage drums and containment pallets.
- Dust pans or shovels.
- Sandbags or bags of other absorbent materials.
- Danger tape.
- Safety cones.
- Helmet/ "hard hat".
- Face shield.
- Chemical resistant aprons.
- Emergency response guidelines.

In the event of spills of flammable or combustible liquids, the following steps are strongly suggested:

Inform all persons in the immediate area to evacuate, except those involved in the clean-up process.

- Notify the safety and security focal point.
- Eliminate all ignition sources, including static electricity, electrical switches, running motors, and exposed wiring.
- Increase ventilation and exhaust fumes to the outdoors.
- Put on the protective equipment.
- Confine the spill by blocking it. This is done by using the absorbent material in the spill kit. Prevent the spill from entering drains or sewer system.
- Cover the spill with absorbent materials and safely and properly dispose of used absorbents.
- Safely dispose of contaminated equipment including personal protective equipment.
- Seal and label all containers of disposed items as hazardous waste.
- Store waste in a safe spot in or near the storage facility, ideally outside, until pickup by a licensed hazardous waste disposal company can be arranged.
- For a major spill, or one that cannot be contained, the area and the warehouse should be fully evacuated.

## **Other Considerations**

The scope and specifics of DG handling requirements depend on the activities of the agency in question, including the types of intervention activities and the sheer volume of DG items

required.

DG in warehouses should always be marked and accounted for. Cartons should always have the appropriate markings, and where necessary DG items might even require signs or marking denoting their location inside the warehouse or storage facility. Depending on the local regulations, warehouses with sufficient quantities of DG may be required to be properly marked or placarded on the outside.

All DG items should be clearly visible and clearly accessible. DG items that give off fumes, are considered combustible, corrosive, oxidising or toxic should be properly sealed and properly ventilated. DG items in containers that display distress or compromise must be removed, repacked, or secured in the appropriate manner. If at all avoidable, DG items of different types should not be stored next to each other in a warehouse, and ideally should be stored in separate structures.

Warehouse staff should be informed of which items are DG, and be instructed on the proper hazards and handling procedures associated with them. Humanitarian agencies should never expect casual or local labour to understand or respect the concerns surrounding DG, and safety should be of paramount concern.

**Toxic or Corrosive Compounds** – Compounds considered poisonous or toxic to humans can range across many DG items. Toxic substances should be well sealed and well-marked. If required, they should be stored in a separate location, and only handled using the appropriate protective gear. Items like refillable lead acid batteries may appear inert, but can cause harm to warehouse workers.

**Explosive Compounds** – While relatively unusual for humanitarian response, agencies can and do handle explosive compounds without realising it. As an example, chemical based fertilisers can be extremely explosive when intermixed with other substances. Explosive compounds should be clearly identified and segregated from the remaining cargo items. If possible, explosive compound should be stored in an entirely separate storage area, ideally someplace not commonly accessed by persons. Explosive compounds should not be exposed to excessive heat, open flames, or other reactive compounds for any period of time.

**Oxidising Compounds** – Corrosive compounds that may be common in humanitarian response included medical grade cleaning compounds or household cleaning supplies. Oxidising compounds react with metals nearby, and can cause violent reactions with fuels and other combustible materials. Though warehouses may take steps to prevent violent reactions with combustible compounds, warehouse workers may not notice the slowly forming impact of oxidisation on other things in the warehouse. Oxidising compounds will slowly degrade shelving, racks, and warehouse super structures increasing risk of serious injury to warehouse workers, as well as impacting any metal objects stored near it. Storage facilities that keep oxidising compounds may end up damaging the objects immediately around the substance over a long period of time without noticing it.

**Bio-hazards** – Bio-hazardous substances such as medical waste or live biological samples should be handled by trained personnel only! Bio-hazardous materials should be properly sealed, and stored in separate secure areas, and at the required temperatures if any exist.

**Pressurised Containers** – It is strongly advised that pressurised containers of any size are not stored in a warehouse for any period of time. Flammable compressed gas should be handled in a separate storage area all together, while non-flammable compressed gas should ideally be stored temporarily, or not at all. If compressed gas or other pressured containers must be stored for any period of time, they should be stored at the ground level and properly braced to





- May not be loaded, transported, or stored together in the same transport vehicle or storage facility. Both main hazard risks and subsidiary risks need to be taken into account.

- May not be loaded, transported, or stored together in the same transport vehicle or storage facility **unless separated** from each other by three meters or more. However, Class 8 (corrosive) liquids may not be loaded above or adjacent to Class 4 (flammable) or Class 5 (oxidising) materials except that the mixture of contents would not cause a fire or a dangerous evolution of heat or gas.

- Segregation among different Class 1 (explosive) materials is governed by the compatibility table. Exception: ammonium nitrate (UN 1942) and ammonium nitrate fertiliser may be loaded or stored with Division 1.1 (Class A explosive) or Division 1.5 (blasting agents) materials.

**Blank Cells** The absence of any hazard class or division or a blank space in the table indicates that no restrictions apply.

**Notes:** **Hazard Zone** - A "hazard zone" means one of four levels of hazard assigned to gasses - Hazard Zones A through D. Hazard Zones A and B are assigned to liquids that are poisonous by inhalation. Consult manufacturer or packaging to identify hazard zones.

**PGI** - "Poisonous Gas".

## Common DG items in Humanitarian Action

Item	Common Issues	Example Item	Possible UN IDs
Batteries	<ul style="list-style-type: none"> <li>• Depending on battery type, may be banned or have limited capability to transport on commercial aircraft.</li> <li>• Some battery types are refillable, and may leak harming handlers or reacting to nearby objects or substances.</li> <li>• Damaged or swollen batteries are forbidden in air transport.</li> </ul>	Lithium ion	UN3480, UN3481
		Sealed lead acid	UN3028, UN2800, UN3090
		Refillable lead acid	UN2794, UN3171
		Lithium metal	UN3090, UN3091
		Blood/medical samples	UN3291
		Live infectious substances	UN2814, UN2900
		Medical waste	UN3291
Biological Hazards	<ul style="list-style-type: none"> <li>• Heavily restricted on some forms of transport.</li> <li>• May require specialised documentation. Requires specialised storage.</li> </ul>		

Item	Common Issues	Example Item	Possible UN IDs
Water Purification	<ul style="list-style-type: none"> <li>Some products that contain NaDCC as an active ingredient may count as DG if they contain a sufficiently large percentage, or are shipped in a sufficient size or sufficient quantities (Example: Aquatabs above 1.67 grams per tablet). Always <a href="#">check SDS from the manufacturer</a> before shipping.</li> <li>Keep away from products bearing the 4.3 hazard label.</li> </ul>	HTH Calcium Hypochlorite	UN1748, UN2208, UN2880
		NaDCC	UN2465
Cleaning Agents	<ul style="list-style-type: none"> <li>If packaging is compromised, may irritate or harm persons handling them.</li> <li>May react to objects and substances stored nearby, causing slow damage or violent energetic reactions.</li> <li>Shade and good ventilation is necessary.</li> <li>When a large quantity must be stored or stowed, if possible, separate in smaller storing quantities.</li> <li>Keep away from products bearing the class 3, division 4.2 hazard labels and in general from any flammable products.</li> </ul>	Alcohol bases hand sanitiser	UN1987
		Chlorine based cleaning solutions	UN1017, UN1908
Compressed Gas	<ul style="list-style-type: none"> <li>Compressed gas cylinders are considered DG even when completely depressurised or empty when transported by air.</li> <li>Compressed gas cylinders may rupture, when stored for long periods of time, or in an unsafe manner.</li> </ul>	Oxygen	UN1002, UN1702
		Fire extinguisher	UN1044
Liquid Fuel	<ul style="list-style-type: none"> <li>Highly combustible depending on the type.</li> <li>Fuel is often inappropriately stored in a high temperature or unventilated rooms, or centrally located in a warehouse.</li> <li>Shade and good ventilation is necessary.</li> <li>Keep away from substances bearing the division 5.1 hazard label.</li> </ul>	Diesel/Gas oil	UN1202
		Gasoline/Petrol	UN1203
		Kerosene	UN1223
		Aviation Fuel/A-1 jet fuel	UN1863
Mechanical Equipment and Fluids	<ul style="list-style-type: none"> <li>Vehicles and generators can be considered DG for air shipping because they contain fuel or other potentially hazardous fluids, all of which usually must be below a minimum level or</li> </ul>	Automobiles/Vehicles	UN3166, UN3171, UN1202, UN2800
		Engines	UN3528, UN3529, UN3530, UN3166
		Generators	UN3166
		Oxygen Generator	UN3356

Item	Common Issues	Example Item	Possible UN IDs
	completely drained before transporting in an aircraft or sea shipping container.	Freezers	UN2857, UN3159
		Antifreeze	UN3082
		Coolants	UN1202
Chemical Fertilizers	<ul style="list-style-type: none"> <li>• May be highly explosive depending on chemical composition.</li> <li>• Storage in high temperature, lowly ventilated areas, or near other reactive substances might cause serious harm.</li> </ul>	Multiple	
Building Related Materials	<ul style="list-style-type: none"> <li>• Require proper declaration and documentation for most forms of transport, and is often highly regulated by air transport</li> </ul>	Pesticides	Many
		Sealants	Many
		Paints	UN1950, UN1263

## Dangerous Goods Lookup Tool

## Dangerous Goods Tools and Resources

### Templates and Tools

[DG Hazard Labels](#)

### Sites and Resources

- [UN Model Regulations, Rev. 12, 2001](#)
- [UN Dangerous Goods List](#)
- [ICAO Technical Instructions for the Safe Transport of Dangerous Goods by Air](#)

## Sustainable Logistics

“Sustainable Logistics and Supply Chain” is an evolving concept in the world of logistics practice that can be described as an integral transformation of logistics strategies, structures, processes, and systems towards a more rational and effective use of resources in supply-chain activities, ranging from the supply of raw materials to the transformation processes, the storage, the packaging, the distribution and the management of the end of the lifecycle of products. Sustainable logistics is becoming more and more relevant in the transition from a linear economic model (based on extraction, transformation, distribution and consumption cycles) to a circular model of economy, whose main goal is to extend the products life and rationalize the use of resources over time.

Sustainability is made up of three pillars: the economy, society, and the environment. These principles are also informally referred as “the 3 Ps” - Profit, People and Planet. By finding a balance among them, logistics can provide the best service while still enforcing and assuring a more conscious resources use.

Green logistics applies a three-dimensional life cycle approach, as opposed to the traditional one-dimensional, economics only focused approach. Following the three-dimensional approach does not necessarily mean that the level of effort and times will increase by three. However, as the organisation reduces its impact on the environment and support positive social behaviours, there may be a return on overall “value for money.”

Pillar	Types of effects
<b>Economic</b>	<ul style="list-style-type: none"> <li>• Economic regeneration</li> <li>• Sustainable economic development</li> <li>• Development of Environmental Management Systems</li> <li>• Total cost of ownership and life cycle costing</li> <li>• Value for money</li> <li>• Poverty reduction</li> </ul>
<b>Environmental</b>	<ul style="list-style-type: none"> <li>• Environmental resource management</li> <li>• Urban planning</li> <li>• CO2 reduction</li> <li>• Alternative energies: e.g.: solar, wind</li> <li>• Water management</li> <li>• Sustainable agriculture</li> <li>• Marine resources management</li> <li>• Protection of ecosystems</li> <li>• Pollution and waste management</li> </ul>
<b>Social</b>	<ul style="list-style-type: none"> <li>• Human rights</li> <li>• Clean drinking water</li> <li>• Food security</li> <li>• Fair pay and labour law protections</li> <li>• Anti-child labour and forced labour laws</li> <li>• Fair trade</li> <li>• Health and safety</li> <li>• Gender equality including universal education</li> <li>• Child mortality and maternal health</li> <li>• Healthy lives and well-being for all</li> </ul>

*World Bank - Sustainable Procurement (2019)*

There is a wide range of initiatives to make logistics as green as possible, and each organisation should evaluate its own goals, capacities and plans to achieve them.

Best practises exist that allow a more sustainable balance between economic, environmental, and social objectives. These might include:



Area of Activity	Actual Situation	Steps to Improve	Benefits
<u>Transport</u>	Fleet causing high amounts of pollution, air quality reduced.	Measure the movements, costs and maintenance of transport to gather data about their use. Invest accordingly in proper maintenance depending of the needs and the selected strategy. This might include: redrawing shorter routes, investing in green vehicles, etc.	Lowered emission transport units, well maintained and following repair plans that reduce environmental and economic cost by increasing the efficacy.
<u>Distribution</u>	Distribution channels not well organised or with big inefficiencies.	Plan supply chain and procurement taking into account the cost to manage the waste produced. Effectively connect places of production with the distribution points, including using proximity to storage/distribution points as a selection criteria. Assess the production line or third level distribution channels of your suppliers for waste or misuse.	Faster deliveries, increased flexibility for late requests, and time savings on managing waste.
<u>Procurement</u>	Price based selection that potentially hides unethical or not environmentally friendly activities.	Create and apply selection criteria that matches the ethical and environmental policies of the organisation. Research initiatives that other organisations are putting in place and adapt them to your situation.	Reputation increase.
<u>Storage</u>	Product loss by degradation caused by poor storage condition, or damages during in-storage movements.	Make improvements in the infrastructure to facilitate cargo movement. Use solar light and natural ventilation. If the infrastructure is going to last more than two years, invest in solar or wind power sources and manage your power consumption. (Power Supply section).	Save money and time.

Area of Activity	Actual Situation	Steps to Improve	Benefits
<b>Packaging</b>	Excessive use of non-biodegradable materials.	Choosing the appropriate mode of transport with enough time, to be able to understand how the cargo is packed and labelled. Try to find a good compromise between safety and handling; Reduce packaging or/and use reusable or biodegradable materials. Example - corrugated cardboard and other forms of paper-based packaging.	Resources saved.

## The WREC Project

Protecting the environment is especially important in humanitarian sector; environmental degradation - due to conflict, natural disasters – is a cross-cutting issue and requires a coordinated intervention to make sure that life-saving activities today don't have unintended impacts that need cleaning up tomorrow. Recent studies on environment in humanitarian action have consistently identified logistics as a stage of supply chain where the risk of unintended impacts is high and where there is a need to [embed environmental expertise to identify scalable solutions](#). To this end, the Global Logistics Cluster with the support of a coalition of humanitarian organizations - Danish Refugee Council (DRC), the International Federation of Red Cross and Red Crescent Societies (IFRC), Save the Children International, and the World Food Programme, set up the Waste Management Measuring, Reverse Logistics, Environmentally Sustainable Procurement and Transport, and Circular Economy (WREC) Project to produce harmonized guidance on waste management and greenhouse gas emissions, increase knowledge and awareness in the humanitarian community about green logistics, and support practitioners in environmental impact reduction, with a special focus for sustained field-based solutions.-

The [WREC Project](#) is bringing together humanitarian partners, the private sector, and academia to make sure that today's life-saving activities don't have unintended environmental impacts that need cleaning up tomorrow. As part of this, the Global Logistics Cluster plays an active role in coordinating and collaborating with those leading complementary initiatives to ensure that this information is both available and contextualized for field-level practitioners' use. You can access the WREC platform here to learn more about the most recent initiatives in humanitarian logistics and find useful guidance to reduce the environmental impacts associated to humanitarian logistics operations.

## Sustainable Logistics Planning and Monitoring

### Environmental Checklist

This series of questions can be used as a check-list to focus on key areas for consideration in the humanitarian sector:

- What environmental risks do your organisation's activities pose?
- Do the materials you use pose any danger to the environment, staff or beneficiaries?

- Do you know what impact the material that you supply (including its disposal) and services you provide have on the environment?
- Do you know the quantity or type of waste you produce?
- Do you know how this waste is disposed of or what the cost is?
- Is your organisation operating the most cost-effective method of controlling or eliminating pollution risk?
- Are there hidden benefits such as greater efficiency, or even straightforward business opportunities (for example, commercial utilisation of waste) from adopting alternative methods of controlling or eliminating the pollution risk?
- Are you aware of existing environmental standards and legislation in the country in which you are operating?
- What arrangement do you have for monitoring compliance with environmental legislation?
- Is senior management actively engaged in ensuring that proper attention is given to environmental considerations in your organisation?
- Could you improve your environmental image to the donors and employees?
- Are you highlighting your environmental performance to donors?

## Environmental Management Systems (EMS)

Logistics and transport activities have been identified as having a major impact on the environment. Consequently, authorities have started to develop significant legislation at both national and international level. Targets for improving environmental performance have been set by the international community via a range of international agreements and meetings, from the Rio Earth Summit in 1992 to the adoption of the Sustainable Development Goals at Rio+20 in 2015 and the climate change related meetings of the Kyoto Protocol, in particular the Paris Accord. International agreements of particular relevance to logistics personnel include the Basel-Rotterdam-Stockholm conventions on management of wastes, the Montreal Protocol on protecting the ozone layer (covering substances including air conditioning gases) and the Minamata convention on phasing out mercury.

Environmental impacts are best managed using a systematic approach that helps organisations to understand all their impacts and address them in some sort of priority order. The most common tool is an environmental management system (EMS), and the best known approach to EMS is laid out by the International Organisation of Standards (ISO) 14000 series of standards. The ISO 14000 family addresses various aspects of environmental management and have been adopted by more than 300,000 organisations worldwide. The first three standards deal with environmental management systems (EMS).

- [ISO 14001:2015](#) Guidance for requirements for an EMS.
- [ISO 14004:2016](#) General guidelines on implementation.
- [ISO 14005:2019](#) Guidelines for a flexible approach to phased implementation.

The other standards and guidelines in the family address specific environmental aspects, including:

- Labelling.
- Performance evaluation.
- Life cycle analysis.
- Communication and auditing.

These standards provide a framework for managing environmental issues rather than establishing performance requirements. The process that starts with a senior management

commitment and the creation of an environmental policy and leads on to:

- Documenting environmental impacts, prioritising them and setting goals for improvement.
- Awareness.
- Planning how stakeholder obligations (including legal requirements) and targets will be met.
- Implementation (including operational controls).
- Training and communicating with staff.
- Control of relevant documentation.

## **Monitoring**

Once an EMS is set up, it is then formally monitored through an auditing process, which will identify any missed targets, procedures not followed or new procedures needed, and document corrective actions required to ensure the EMS meets its objectives. Managers are required to engage in this process and review the system performance on a regular basis. Performance review may lead to the policy or objectives being changed or updated, in light of the audit reports or changes in circumstances. This process should encourage a commitment to continuous improvement in environmental management as well as ensure that the organisation is not exposed by failing to meet its legal and moral obligations.

## **Performance Measurement**

Organisations with environmental management systems will attempt to monitor their performance, and simple measures might include:

- Volume of fuel used to keep an operations running over a defined period of time, including:
  - Operating vehicles.
  - Running generators.
  - (If possible) fuel used by third party transport providers.
- Proper maintenance and repair of equipment, including:
  - Monitoring the changing/degrading performance of generators and vehicles.
  - Monitoring consumption of dependant/support equipment (tyres, filters, etc).
  - Proper disposal of waste oils and lubricants.
- Proper transport utilisation, including:
  - Avoiding sending vessels empty or partially loaded.
  - Sharing transport resources with other agencies.
  - Understanding international transport needs, especially items transported by air.
- Setting targets for reducing waste reduction, including:
  - Minimising spoilage and expiration of stored items.
  - Reducing packaging requirements for relief items.
  - Environmentally friendly disposal of expired commodities.
  - Ensuring a proper disposition plan for all items.

## **Minimising Negative Environmental Impacts**

### **Sustainable Energy Production**

Humanitarian organisations often work in austere, off-grid environments. Using generators that burn petrochemicals is extremely common. While generators may be unavoidable in many

contexts, there are steps agencies can take to reduce waste and environmental impact.

- Set standard working hours for generators – generators already have limits to the lengths of time they can operate, and where security permits agencies may choose “off hours” to avoid burning fuel when unnecessary.
- Properly service and maintain generators wherever they are in use. Properly serviced generators also will save money and enhance security.
- Invest in a solar electric or battery backup system to generate and supply electricity to offices and compounds. Battery and solar systems are often great tools to augment power systems, and can be used alongside regular generators.

For more information on the proper methods of [maintaining a generator](#), on selecting and installing a [solar electric system](#), and on using [battery back-up systems](#), please reference the [electrical power generation](#) section of this guide.

## Sustainable Use of Vehicles

Vehicles are widely used within the humanitarian context, and operating in and around them is almost unavoidable. There are many steps to take to ensure the most sustainable and environmentally friendly performance of vehicles. These might include:

- Selecting fuel efficient vehicles and ensuring right-sizing of fleets.
- Driver training to reduce accidents and improve fuel consumption.
- Monitoring fuel consumption.
- Monitoring vehicle utilisation in terms of both payload and empty running.
- Conducting preventative maintenance, as a poorly serviced vehicles use more fuel.
- Dispose of used tyre casings, batteries, motor oil and other vehicle waste responsibly.

A proper maintained fleet has the advantage of being both environmentally friendly, but also cost efficient. For more information on [vehicle selection](#), [vehicle and fleet monitoring](#), and [proper maintenance](#), please reference the [vehicle and fleet management](#) section of this guide.

## Waste Management

Unintended by-products of humanitarian action (e.g. plastics and packaging required to safeguard the quality of the relief items, food or non-food, hazardous materials from organizations’ vehicle fleets like used tyres, motor oils and lubricants, batteries and end-of-life vehicles, dangerous fumes from the burning of waste) impact negatively on local human and ecological health, and they typically occur in contexts where systems to manage them sustainably do not exist. Waste management can be defined as the set of practices, processes and policies aiming at measuring and reducing the overall waste volumes of an organization. Typically, waste management practices should be prioritised according to the following scheme:

- Reduce
- Reuse
- Recycle

The final objective of effective waste management is reducing waste at the source, for example avoiding unnecessary packaging, banning single-use plastics and introducing mechanisms to plan needs in a way to minimize the quantity of waste or by-products to dispose of.

Effective steps to understand the different waste streams on site, identify the most suitable

disposal options, and continuously improve on-site waste management include:

- Introducing a Solid Waste Inventory; This exercise allows to identify all the waste generated and disposed of either on-site and/or off-site. It is completed by performing a physical inspection of current waste storage locations in the compound/facility and/or referring to invoices from waste contractors.
- Identifying the most appropriate disposal methods for each type of waste, from “Best option” to “Last resort”.
- Identification of local contractors and potential with adequate capacity to treat and dispose of hazardous and non-hazardous waste in collaboration with procurement teams.
- Set-up and regular inspection of storage areas to ensure separation of waste streams.

## **Sustainable Packaging**

Logistics departments of humanitarian agencies frequently deal with packaging of materials. Packaging represents one of the greatest challenges to environmentally friendly logistics while at the same time being vital in shipping and storage.

Packaging has consequences for transportation, storage methods, and space requirements of a given space. Packaging can increase the unit cost if it hinders optimisation of storage space. Many industries have developed forms of packaging that can withstand the stresses of transport but do not justify the expense of returning them to the point of origin, being used once and then discarded.

Steps to take when planning packaging:

- Plan for biodegradable overpacking such as cardboard cartons.
- Where possible, plan for recovering packing materials, recycling them locally or even returning them to the vendor for re-use. Suppliers and the buyers should seek to recover and recycle or effectively dispose of packaging.
- Reduce the size of packing, requiring less space to store and less fuel to transport.
- Investigate local companies that may engage in environmentally friendly solid waste disposal and recycling.
- Where packing cannot be made from bio-degradable material or material reduced, consider kitting and repackaging into sustainable packing before the last mile of distribution to avoid uncontrolled disbursement of wasteful materials.

## **Green Facility Management**

There are many steps agencies may take to enhance the sustainability of working and living premise and warehouses. These might include:

- Avoiding wasting water by using water efficient taps, leak prevention and recycling methods.
- Install energy efficient light bulbs.
- Using interceptor tanks to avoid run-off pollution from fuel dispensing areas.
- Phase out of ozone-depleting gases from air conditioning systems in warehouses and compounds.
- Develop a strategy for managing e-waste (old computers, communications equipment) and batteries.

In warehouse and stock keeping:

- Utilise proper stock management methods to avoid infestation, spoilage, damage and expiration, all of which lead to waste and disposal.
- Exercise careful management and monitoring of hazardous chemicals to avoid spillage or leaking.
- Taking steps to better manage the production, collection and disposal of waste, including packaging wastes.

For more information on proper stock keeping methods, please reference the [warehousing and physical stock management](#) section of this guide. [Managing fuel](#) and handling [hazardous materials](#) can also be found.

## Green Procurement

*“ Sustainable procurement is the act of adopting social, economic and environmental factors alongside the typical price and quality considerations into the organisations handling of procurement processes and procedures. (CIPS)*

The procurement process is an excellent time to assess and commit to green logistics practices. Sustainable procurement considers the environmental, social and economic consequences of design, materials used, manufacturing methods, logistics and disposal. In green procurement organisations can meet their needs for goods, services, and utilities in a way that achieves value for money while still addressing principles for sustainable development.

The aim and challenge of sustainable procurement is to integrate environmental and social considerations into the procurement process. One of the most powerful methods is to choose the appropriate selection criteria with sustainability in mind, clearly inform potential bidders, and ensuring all requirements are properly met. A guide to developing [solicitations for vendors](#) can be found [procurement](#) section of this guide.

Example of selection criteria might include:

<b>Economic</b>	<b>Social</b>	<b>Environmental</b>
Previous/current experience Accreditation by independent certification organisation.	Accreditation by independent certification organisation to a standard.	Impact of materials used and processes of production.
Productivity/service capacity.	Evidence that workers know their rights and responsibilities at work.	Impact of packaging.
Design robustness/innovation.	Presence of independent trade unions or effective management/worker committees which address workers’ priorities, including pay, hours and conditions.	Impact of transport (air freight from Europe may be greater than sea freight from Asia/Africa).
Whole-life costing of product	Sub-supplier practices and conditions.	Impact of product life cycle.

## Economic

## Social

## Environmental

---

Switching cost of current supplier.

Participation in multi-stakeholder initiatives that educate and change practices to address ingrained problems.

---

Source: CIPS, Chartered Institute of Purchasing and Supply Chain, (2013). [Ethical and sustainable procurement](#).

Ongoing procurement has had such an impact on green logistics that ISO has developed a specific Standard able to guide every procurement decision.

- [ISO 20400](#) Sustainable procurement standard.

Formed on the bases of ISO 26000 for Social Responsibility, sustainable procurement relies on:

- Assess the organisational "buying culture" - Understand how and from who the organisation buys/sells to, the control over sub-suppliers as well as sub-supplier capacities to accommodate green demands, and if green requirements are realistic and expressed clearly.
- Know the organisation supply chain - Evaluate the cost of the supply chain, and the proportion of the revenue that goes towards paying suppliers. Assess the suppliers societal and environmental impact.
- Think strategically; Consider the risks and opportunities of working more closely with the main suppliers across the whole life cycle of products and services.
- Get buy-in from top management - Ensure key decision makers are on board and aware of the benefits, opportunities, and possible consequences of implementing sustainable procurement into the organisation.

## Reverse Logistics

Reverse logistics has been traditionally defined as the process of moving a product from its point of consumption to the point of origin to recapture value or ensure proper disposal. It is one of the fastest developing fields of commercial logistics, resulting in continuously changing scope and significance. Reverse logistics includes activities that:

- Avoid return of assets or items.
- Reduces materials in the forward system so that fewer items flow back.
- Ensures the possible reuse and recycling of materials and packaging.

It is important to ensure that aid projects are handled in a responsible manner and that they do not end up causing long term damage to the very people and societies that they are intended to assist.

*Reverse logistics is the management of all the activities involved in the flow of goods, demand information and money in the opposite direction of the primary logistics flow, including reduction in the generation of waste, and management of the collection, transport, disposal, and recycling of hazardous, as well as non-hazardous waste, in a way that maximizes the long-term profitability of the business.*



Reverse logistics covers a broad range of items and activities and can include:

- Movement of capital items and equipment to the next emergency response.
- Removal of containers and packaging from an area of intervention.
- Destruction of spoiled food commodities and out of date pharmaceuticals.
- Return of rejected goods to suppliers.
- Movement of excess or over-supplied goods to other programmes or organisations.

Reverse logistics occurs in the humanitarian sector when:

- Downscaling of activities:
  - Goods have to be moved to different programmes or disposed.
  - Evacuation due to insecurity - may result in the suspension of activities when goods have already been purchased and have to be returned to the supplier or used in other programmes.
- Closing programmes or ending of emergencies prompts the handover of items
- Products are recalled by their manufacturer
- Rejected goods are returned to the vendor due to:
  - Incorrect orders.
  - Incorrect deliveries.
  - Deliveries being delayed and goods no longer useful to the programme.
  - Damaged goods.
  - Goods on warranty or going for repair.
- Back-trucking of packaging materials for re-use or disposal.

In all instances listed above, there are cost implications that should be taken into consideration during the budgeting and planning period.

## **Circular Economy**

The circular economy is based on three principles, driven by design:

- Eliminate waste and pollution
- Circulate products and materials at their highest value
- Regenerate nature

A circular economy is underpinned by a transition to renewable energy and materials. A circular economy decouples economic activity from the consumption of finite resources. It is a resilient system that is good for business, people and the environment.

## **Sustainable Logistics Tools and Resources**

### **Sites and Resources**

- [Sustainable Procurement guidance for practitioners to sustainable procurement in World Bank IPF projects, World Bank, \(2019\)](#)
- [CIPS, Chartered Institute of Purchasing and Supply Chain, \(2013\). Ethical and sustainable procurement](#)
- [UN, United Nations, \(2006\) Procurement practitioners handbook](#)
- [Fleet Forum](#)
- [Clean Fleet Toolkit](#)
- UN WFP, Safe Management of Hazardous Waste in WFP Workshops ([English](#), [French](#))
- [USAID BHA \(2020\), Sustainability in Humanitarian Supply Chains](#)

- [Global Logistics Cluster & Hanken University \(2022\), Waste management and Reverse Logistics in the Humanitarian Context](#)
- Ellen MacArthur Foundation, "[What is a circular economy?](#)"

## Humanitarian Response Architecture

The humanitarian operational environment is the one in which international and national aid organisations and commercial sector entities function and interact with during emergencies. It is significantly different from any other operating environment as all activities involved aim to delivery of humanitarian assistance in whatever form. There is no single organisation capable of delivering this assistance adequately on its own, hence the need to coordinate and collaborate with other entities to efficiently achieve this objective. Organisations operating in this environment include:

- National and local governments.
- United Nations agencies.
- The Red Cross and Red Crescent Movement.
- National and international non-governmental organisations (NGO).
- Commercial companies.
- Military forces.
- Donor agencies.

To facilitate engagement between these various entities, inclusive and well-defined structures – known as “clusters” – were created. To ensure accountability and efficiency, lead organisations for each cluster have been identified globally based on their sectors of expertise.

Enabling humanitarian actors to maximise their limited resources usage, ameliorate their efficiency, and demonstrate accountability, the [cluster approach](#) facilitates operations in multiple contexts. Therefore, clusters serve as a coordination mechanism improving the overall humanitarian responses thanks to the increased interaction they enable amongst all involved stakeholders working in the same sector (*e.g.* logistics, health, shelter). Each cluster operates under the leadership of a “lead agency” – accountable for its actions – usually selected according to its area of expertise (*e.g.* WHO is the Health Cluster lead agency).

## Humanitarian Principles

The principles of humanitarian practice aim to ensure the fundamental human rights of those affected by conflicts or natural disasters are safeguarded, notably by providing them with adequate protection and assistance. Simultaneously, humanitarian actors strive to minimising the potential negative externalities of such assistance and preparing for future emergencies. Humanitarian action includes – but is not limited to – the protection of civilians in crisis by meeting their basic needs for food, water, sanitation, shelter, and health care. It is furthermore geared to assist affected populations to return to normal lives and livelihoods. Humanitarian practice is guided by the humanitarian law and a range of international standards and codes of conduct including:

- [Universal Declaration of Human Rights 1948.](#)
- [Fourth Geneva Conventions of 1949 and additional protocols of 1977.](#)
- [Principles of Conduct for the International Red Cross and Red Crescent Movement and NGOs in Disaster Response Programmes.](#)
- [Sphere Project Humanitarian Charter and Minimum Standards in Disaster Response](#)

International humanitarian workers therefore abide by the following core humanitarian

principles:

- **Humanity** – alleviate suffering wherever it is found to protect life and health and ensure respect for human beings.
- **Impartiality** – to act on the basis of needs, without discrimination.
- **Neutrality** – to act without taking sides for one group or another.
- **Independence** – to ensure humanitarian action autonomy from specifically political, economic or military interests.

## Humanitarian Operating Environment

### Stakeholders in Emergency Environments

It is important that humanitarian logistics staff fully understand the environment in which they are operating and the respective roles the various humanitarian stakeholders they may interact with have. Below are listed the main bodies that are usually involved in any given emergency where humanitarian actors are deployed:

- Inter-Agency Standing Committee (IASC)
- United Nations Operational Agencies
- United Nations Coordination Mechanisms
- National Government Authorities
- The Red Cross and Red Crescent Movement
- Non-Governmental Organisations (NGOs)
- Department of Peacekeeping Operations (DPKO)
- Donor Agencies

### Inter-Agency Standing Committee

The [Inter-Agency Standing Committee \(IASC\)](#) is a unique forum for coordination, policy development, and decision-making involving United Nations and non-United Nations agencies. IASC is the primary global mechanism for inter-agency coordination of humanitarian assistance. Under the leadership of the Emergency Relief Coordinator appointed by the United Nations Secretary-General – the IASC develops humanitarian policies, agrees on a clear division of responsibility for the various aspects of humanitarian assistance, identifies and addresses gaps in response, and advocates for effective application of humanitarian principles.

The IASC forum is composed by the heads (or designated representatives) of the United Nations operational agencies (*i.e.* FAO, OCHA, UNDP, UNFPA, UNHABITAT, UNHCR, UNICEF, WFP, and WHO) and other humanitarian organisations such as ICRC, ICVA, IFRC, InterAction, IOM, OHCHR, RSG on Human Rights of IDPs, SCHR, and the World Bank. The number of participating agencies has expanded since the IASC inception in 1991. On the global level, the IASC meets formally twice a year and deliberates on issues brought to its attention by the ERC and by the IASC Working Group. The [IASC Terms of Reference](#) may be consulted here.

### United Nations Operational Agencies

In the United Nations system consists of a number of programmes, funds, and specialised agencies, each with their specific mandate and set of expertise, that are responsible for carrying out relief and recovery activities. Their wide-ranging activities include identifying humanitarian needs through various assessments as well as designing and implementing relief programmes to assist and support affected populations. The overarching structure of these

entities can be found in [United Nations Organisational Chart](#)

Furthermore, for more specific details, the below links lead to their main online platforms:

- [FAO](#) - Food and Agriculture Organization of the United Nations
- [UNHABITAT](#) - United Nations Human Settlements Programme
- [UNHCR](#) - United Nations High Commissioner for Refugees
- [WHO](#) - World Health Organization
- [WB](#) - World Bank
- [UNFPA](#) - United Nations Population Fund
- [UNICEF](#) - United Nations Children's Fund
- [UNDP](#) - United Nations Development Programme
- [WFP](#) - World Food Programme

## **United Nations Office for the Coordination of Humanitarian Affairs**

The [Office for the Coordination of Humanitarian Affairs \(OCHA\)](#) is the arm of the United Nations Secretariat responsible for bringing together humanitarian actors to ensure coherent and coordinated response to emergencies. OCHA also works to define a framework within which each actor can efficiently contribute to the overall response effort.

OCHA's mission is to mobilise and coordinate effective and principled humanitarian actions in partnership with national and international actors in order to:

1. Alleviate human suffering during crises.
2. Advocate for the rights of people in need.
3. Promote preparedness and prevention.
4. Facilitate sustainable solutions.

## **UN Representatives and Coordinators**

### **Special Representative of the Secretary-General**

A Special Representative of the Secretary-General (SRSG) is appointed by the United Nations Secretary-General to act on his behalf in "complex or of exceptional magnitude" emergencies. In practice, the appointment of an SRSG is normally reserved for emergencies requiring United Nations involvement in major political negotiations and/or when United Nations peacekeeping forces are deployed.

When a SRSG is appointed, he/she is recognised as having overall authority with regard to United Nations operations in the designated country. If heading a peacekeeping operation, the SRSG reports to the Secretary-General through the Under-Secretary-General (USG) for peacekeeping operations or, if heading a political mission, through the USG for political affairs.

A SRSG is also involved when an Integrated Mission is proposed for the planning, design, and implementation of complex United Nations operations in post-conflict situations, and for linking the different dimensions of peace support operations. An Integrated Mission enshrines a shared vision amongst all United Nations actors being the strategic objective their collective work in-country will focus on achieving. Once an Integrated Mission is established following a specific Security Council Resolution, the SRSG will take the lead in the planning process in close cooperation with the Integrated Mission Task Force (IMTF).

## **Emergency Relief Coordinator**

The Emergency Relief Coordinator (ERC) is the United Nations Under-Secretary-General for Humanitarian Affairs and head of OCHA. The ERC is responsible for oversight of all emergencies requiring United Nations humanitarian assistance and leads the IASC, acting therefore as the central focal point for governmental, intergovernmental, and non-governmental relief activities. The Global Cluster lead agencies are accountable to the ERC in ensuring better coordination and effective humanitarian response through cluster activities.

## **Humanitarian Coordinator**

When a complex emergency occurs, the ERC, on behalf of the Secretary-General and after consultation with the IASC, designates a Humanitarian Coordinator (HC). The HC serves as the representative of the ERC (and therefore of OCHA) in the country/region concerned. The HC is responsible for coordinating the Humanitarian Country Team activities and provides liaison between the latter and the ERC. The Cluster lead agencies in-country are accountable to the HC for their Cluster lead responsibilities.

## **Humanitarian Country Team**

In April 2006, the IASC Principals (i.e. heads of the IASC participating agencies) endorsed the [Action Plan](#) on "Strengthening the Humanitarian Coordination System" which states, *inter alia*, that all HCs must have "broad-based country teams developed [and] in place by November 2006."

A broad-based country team, established through a Humanitarian Country Team (HCT), aims to improve humanitarian coordination and policy making as well as ensuring positive and efficient partnership between all humanitarian actors. Chaired by the HC, the HCT consists of UN agencies, NGO partners, and the Red Cross and Red Crescent Movement operating in a given country. Non-members may be invited in its fora on an *ad hoc* basis for the purpose of assisting in the discussions and/or taking action on specific humanitarian issues.

## **Resident Coordinator**

A United Nations Resident Coordinator (RC) is a designated representative of the UN Secretary-General. They lead the HCT and reports to the UN Secretary-General through the Chair of the UN Development Group (UNDG). The RC terms of references may be found [here](#). Generally, the UNDP Resident Representative serves as the RC. Through such coordination, the most effective use of UN and other international aid resources is being pursued. Furthermore, in the event of a humanitarian response where a HC position has not been established, the RC is accountable to the ERC. This applies for the strategic and operational coordination of the response efforts of UN Country Team members, national, and international humanitarian organisations in support of national efforts. The ERC may choose to designate the RC as HC, in consultation with the IASC, if the situation so requires. The Cluster leads at the country level are accountable to the RC in the absence of a HC.

## **United Nations Country Team**

The United Nations Country Team (UNCT) structure encompasses all the UN system entities carrying out operational activities for development, emergency, recovery, and transition in a given country. It ensures interagency coordination and a structured decision making process for agencies present in-country. The UNCT aims for individual agencies to plan and work together, as part of the RC system, in order to ensure the delivery of tangible results in support

of the development agenda of the government.

The UNCT membership, roles, and responsibilities must also be laid out clearly within each UNCT. These imply accountability to each other and to the RC, taking responsibility for elements of the RC/UNCT work plan – particularly in oversight of subsidiary groups – mobilisation of resources for the UNDAF and UNCT plans, and taking part in mutual assessments.

## **National Government Authorities**

The [UN General Assembly Resolution 46/182](#) states that “[...] each State has the responsibility first and foremost to take care of the victims of natural disasters and other emergencies occurring on its territory[...]” and that “[...] the affected State has the primary role in the initiation, organisation, coordination, and implementation of humanitarian assistance within its territory”.

The UN therefore encourages governments to “[...] designate a single national agency or organisation to conduct and coordinate emergency relief measures.” The establishment of such government authority to coordinate domestic relief activities upholds the stricken country’s government central role and responsibility in disaster relief operations. Where possible, external coordinating mechanisms – such as clusters – should systematically involve the relevant government authorities.

In the case of man-made crises, coordination of relief activities and reporting structures are agreed between the government and the HC.

## **The Red Cross and Red Crescent Movement**

The Red Cross and Red Crescent Movement is the largest humanitarian network in the world and is prevalent in all aspects of relief work. It is therefore likely to be an integral part of the emergency environment and may play an important role in coordinating humanitarian assistance in complex emergencies. The Red Cross and Red Crescent Movement is composed of three elements:

- The International Committee of the Red Cross (ICRC) mission is to protect the lives and dignity of victims of armed conflict and other situations of violence and to provide them with assistance. It directs and coordinates the Movement’s international relief activities during armed conflicts. Established in 1863, it is at the origin of the Movement. The ICRC plays an active role in most complex emergencies.
- The International Federation of Red Cross and Red Crescent Societies (IFRC) is a federation of national societies worldwide. It aims to inspire, encourage, facilitate, and promote all forms of humanitarian activities by its member societies with a view to preventing and alleviating human suffering. When disasters occur, the IFRC assists national societies in assessing needs, mobilising resources, and organising relief activities. IFRC delegates are often assigned to give direct assistance to national societies. Personnel from other national societies may also be requested and assigned under the auspices of the IFRC.
- The National Red Cross and Red Crescent Societies act as auxiliaries to public authorities and services. They normally concentrate on activities concerned with public health – including first aid and primary health care – and relief. Many national societies also maintain stocks of relief supplies. They usually receive funds from their own membership, from local fund-raising activities, and in many cases from their respective government.

## Non-Governmental Organisations

Non-Governmental Organisations (NGOs) can be divided into two main categories: international NGOs operating overseas, and local NGOs working in their national context. The NGO community has become increasingly important in humanitarian responses and has significantly grown in number over the past decades to cover the full spectrum of humanitarian relief activities.

Before, during, and after the onset of a crisis, NGOs are often present in the area of an emergency. They therefore have hands-on experience and information that might be crucial in carrying out large-scale relief operations. NGOs tend to specialise in one or two fields, and/or to direct their efforts towards a specific in-need population. They usually offer skilled staff, rapid deployment capacity, operational flexibility, and resources that might not otherwise be available in an emergency.

Local NGOs are particularly important as they are known locally and because their staff is familiar with the context, area, culture, various communities, *etc.* In many cases they are used to work together with other international NGOs and the UN agencies. The UN Department of Economic and Social Affairs maintains a list of [NGOs in consultative status with the United Nations](#).

## Armed Forces in Humanitarian Response

### Department of Peacekeeping Operations

The [Department of Peacekeeping Operations \(DPKO\)](#) is a UN body tasked by the Security Council to undertake peacekeeping operations in specific areas of recent or potential conflict. A Special Representative of the Secretary-General (SRSG) is usually appointed to lead each peacekeeping operation. Reporting to DPKO headquarters in New York, the SRSG exercises authority over all UN entities in the emergency area. The SRSG office has two main components: a civilian structure headed by the Chief Administration Officer (CAO) and a military structure headed by the Senior Military Officer (SMO).

DPKO staff deployed into an emergency area may for instance include military components in security or observation roles, civilian police elements, mine action teams, as well as specialists in political affairs and human rights.

Recent peacekeeping mandates have also included tasks such as “coordination with humanitarian agencies” or “support to humanitarian action.” The personnel, material, and financial assets of these operations are managed by a civilian led administration, headed by the CAO.

### Civil-Military Coordination

Civil-Military Coordination (CMCoord) is the essential dialogue and interaction between civilian and military actors in humanitarian emergencies that is necessary to protect and promote humanitarian principles, avoid competition, minimise inconsistency, and when appropriate, pursue common goals. Basic strategies range from coexistence to cooperation. Coordination is a shared responsibility facilitated by liaison and common training.

CMCoord is a framework that enhances a broad understanding of humanitarian action and guides political and military actors on how best to support that action. It assists in developing

context-specific guidance based on internationally agreed guidelines, it establishes humanitarian civil-military coordination structures, and ensures that CMCoord Officers and focal points are trained to make that coordination work. The CMCoord Officer can also function as an auxiliary to humanitarian access, protection and security, and facilitate these workstreams as needed. This applies to complex emergencies and natural disasters.

CMCoord is the official term used by the UN to describe the process of liaison between civilian and military actors in a crisis area, however military authorities may also appoint their own staff for liaison duties with the humanitarian community. The generic military term for liaison between humanitarian and military bodies is Civil-Military Coordination (CIMIC), however military authorities or formations may use different terminology.

## **Humanitarian Funding**

Humanitarian organisations are funded by contributions from individuals, corporations, governments, and other organisations. Each humanitarian agency usually has its own resource mobilisation mechanism in place having either bilateral or multilateral contributions provided by donors. In addition to traditional donors such as government and inter-governmental organisations, private donors are taking on an important part in supporting relief operations.

## **Donor Agencies**

Donor agencies may be present in the crisis area and may even be actively involved in disaster relief activities before a major emergency occurs. Some of these donor organisations, especially governmental organisations, have developed concepts for rapid intervention in case of disaster and will deploy with specialised teams. Each donor government typically has specialised sub-offices for granting funds and liaising with various humanitarian actors. The funding processes and requirements are regularly updated and vary from donor to donor. Organisations seeking funding should consult with the relevant donor office for up to date information.

## **Appeals**

At the onset of an emergency, humanitarian organisations come together to prepare an appeal summarising relief needs and response plan for different sectors. These appeals are tools to structure humanitarian response and mobilise funding.

### **Flash Appeal**

Flash appeals present an early strategic response plan and specific projects within 5-7 days of the emergency's onset. If major uncertainty exists about the evolution of the crisis, the appeal presents the most likely scenarios and the response strategy for each. Flash appeals are usually revised about a month later, when more information is available. They may serve as the basis for funding applications to the CERF (amongst other funding streams): the RC/HC indicates which appeal projects the CERF should fund. The RC/HC, supported by OCHA, is responsible for producing the appeal. Organisations that have been asked to lead and coordinate the response within a given sector or area of activity (i.e. cluster or sector leads) have a key role: working with all relevant partners to develop the response plans and vet project proposals for inclusion in the appeal. Flash appeals should include priority projects from all key implementing agencies on the ground, including NGOs.

### **Consolidated Appeals Process**



The Consolidated Appeals Process (CAP) is a programme cycle for aid organisations to plan, coordinate, fund, implement, and monitor their response to disasters and emergencies, in consultation with governments.

The CAP contributes significantly to developing a strategic approach to humanitarian action, and fosters close cooperation between host governments, donors, aid agencies, and in particular between NGOs, the Red Cross Movement, and UN agencies. Working together in the world's crisis regions, they produce a Common Humanitarian Action Plan and an appeal for funds.

## **Common Humanitarian Action Plan**

The Common Humanitarian Action Plan (CHAP) outlines humanitarian actions in a given country or region. It provides:

- Analysis of the context in which humanitarian actions takes place.
- Best, worst, and most likely scenarios.
- Analysis of need and a statement of priorities.
- Roles and responsibilities -who does what, when and where.
- A clear link to longer-term objectives and goals.
- A framework for monitoring the strategy and revising it if necessary.

The CHAP is the foundation for developing a Consolidated Appeal that presents a snapshot of situations, response plans, resource requirements, and monitoring arrangements. If the situation or people's needs change, any part of an appeal can be revised at any time.

Whenever crises break or natural disasters occur, humanitarian partners develop a Flash Appeal to address people's most urgent needs. This can later become a Consolidated Appeal.

Humanitarian Coordinators are responsible for preparing the Consolidated Appeals, launched globally by the UN Secretary-General before the beginning of each calendar year. Mid-Year Reviews are presented to donors in July of each year.

## **Pooled Funds**

### **Emergency Response Fund (ERF)**

The Emergency Response Fund (ERF) aims to provide rapid and flexible funding to address gaps in humanitarian needs. It is usually established to meet unforeseen needs that are not included in the CAP or similar coordination mechanisms but in line with CHAP objectives and identified priorities. It increases opportunities for local actors to respond to needs in areas where international organisations face challenges to access due to security or political constraints. Compared to Central Emergency Response Fund (CERF) and Common Humanitarian Fund (CHF), ERFs amounts are relatively small. OCHA typically undertakes both financial and programmatic management of ERFs and provides an overview and tracking [here](#).

The ERFs aim to enable NGOs (which do not have direct access the CERF) – but also sometimes UN agencies – to respond quickly and effectively by:

- Making funds available to cover initial costs
- Making funds available in cases of rapidly changing circumstances and humanitarian needs where gaps must be filled and other donor mechanisms are unavailable.

### **Common Humanitarian Funds**

Common Humanitarian Funds (CHF) are country-based pooled funds that provide early and predictable funding to NGOs and UN agencies for their response to critical humanitarian needs. CHFs enable Humanitarian Country Teams—who are best informed of the situation on the ground—to swiftly allocate resources where they are most needed, and to fund priority projects as identified in a Consolidated Appeal Process (CAP), or a similar humanitarian action plan.

CHF mainly provide core funding to projects included in a CAP and they enable humanitarian actors to respond to protracted crises. CHFs also maintain an emergency reserve used for unforeseen emergencies and new priorities in a crisis. The reserve typically does not exceed 10 per cent of total CHF funds. CHFs are under the authority of the Humanitarian Coordinator (HC), with support from OCHA and UNDP for the fund's day-to-day management and financial administration.

## **Central Emergency Response Fund**

The Central Emergency Response Fund (CERF) is a humanitarian fund established by the General Assembly in 2006 to enable more timely and reliable humanitarian assistance to those affected by natural disasters and armed conflicts. The fund is replenished annually through contributions from governments and the private sector, and constitutes a pool of standby funding to support humanitarian action.

The CERF has a grant facility of USD 450 million and a loan facility of USD 30 million. In an average year, CERF allocates approximately USD 400 million to 50 different country teams. Sectors that typically receive funding include food, health, water and sanitation, and shelter. CERF has a ceiling of USD 30 million for each humanitarian emergency. Two thirds of CERF allocations go to rapid response allocations (for a sudden-onset emergency or a significant deterioration in an existing crisis) within 72 hours of an application being received from a Resident/Humanitarian Coordinator (RC/HC).

The CERF is designed to complement existing humanitarian funding mechanisms, including the CAP, flash appeals, and country-based pooled funds. United Nations humanitarian agencies and the International Organization for Migration can apply for CERF funding. WFP, UNICEF and UNHCR are the top three agency recipients of CERF funding. Applications for CERF funding must demonstrate that proposed activities are in line with CERF's life-saving criteria. The RC/HC submits applications to the Emergency Relief Coordinator (ERC) and the CERF secretariat, based on an in-country prioritization process. The General Assembly resolution that created CERF does not allow for NGOs to apply directly for CERF funding. However, NGOs frequently receive CERF funding when they act as implementing partners of United Nations agencies. OCHA cannot receive CERF grants as the ERC is the Fund Manager.

More information regarding the CERF may be found [here](#).

## **Cluster Approach**

Introduced in 2005 as part of the broad Humanitarian Reform and further elaborated under the Inter-Agency Standing Committee (IASC) [Transformative Agenda](#), the Cluster Approach aims to make humanitarian response more predictable through better sectoral coordination amongst humanitarian actors. The objective is to facilitate more predictable leadership and cooperation, strengthen partnerships, improve planning and prioritisation, and enhance accountability.

## **Overview of The Cluster Approach**

As defined by the [IASC Guidance Note](#), Clusters are made up of humanitarian organisations – including UN agencies, non-governmental organisations (NGOs), the Red Cross and Red Crescent Movement, and other civil society organisations – as well as, in some cases, other stakeholders – including government representatives. These organisations work together to address needs identified in a specific sector (e.g. logistics, camp coordination, health, protection). Clusters provide a framework for actors engaged in a sectoral response to: Respond jointly to needs that have been commonly identified; Develop appropriate strategic response plans with shared objectives; and Coordinate effectively – both amongst themselves and with the national authorities leading the response.

The Cluster Approach is intended to strengthen the overall capacity, effectiveness, and management of humanitarian response in four key ways:

- Ensuring more predictable leadership and clearly defined responsibilities by identifying Cluster Leads that are accountable for the coordination of the activities of their respective sector.
- Ensuring timely and effective responses, including through the maintenance of global capacity, rosters of trained experts, and stockpiles.
- Strengthening partnership between all humanitarian actors and ensuring more coherent linkages with national authorities.
- Improving strategic field-level coordination and prioritisation, leading to fewer gaps and duplication.

There are **11 global clusters**, each with clearly designated lead agencies and specific Terms of Reference agreed by the IASC that outline roles and responsibilities. The Cluster Approach is flexible and is not imposed at country-level in a “one size fits all” as its coordination aims to be field and needs-driven.

Cluster Activity	Lead Agency
Camp Coordination and Camp Management	<a href="#">IOM/UNHCR</a>
Early Recovery	<a href="#">UNDP</a>
Education	<a href="#">UNICEF</a>
Emergency Telecommunications	<a href="#">WFP</a>
Food Security	<a href="#">WFP &amp; FAO</a>
Health	<a href="#">WHO</a>
Logistics	<a href="#">WFP</a>
Nutrition	<a href="#">UNICEF</a>
Protection	<a href="#">UNHCR</a>
Shelter	<a href="#">IFRC/UNHCR</a>
Water, Sanitation and Hygiene (WASH)	<a href="#">UNICEF</a>

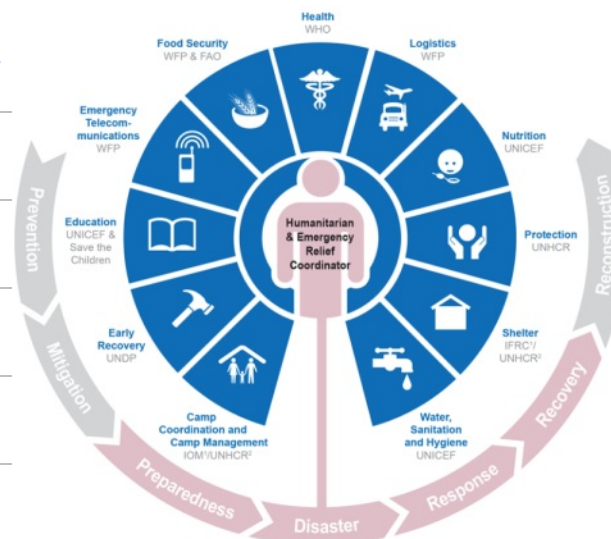

In any humanitarian response, the Humanitarian Coordinator (HC) – or the UN Resident Coordinator (RC), if no HC has been appointed – in consultation with the Humanitarian Country Team (HCT), agrees on the priority sectoral needs and related coordination structures (*i.e.* Clusters) that are appropriate to the response. The HC/RC and HCT also agree on which humanitarian actors are best placed to take on a Cluster leadership responsibility in the specific country context. The decision is based on organisational presence, capacity and willingness, and the global cluster leads structure agreed by the IASC. Due to capacity and resources, a UN agency usually functions as Cluster Lead but, increasingly, civil society organisations play a leadership or co-leadership role. Subsequently, the HC shares the agreement regarding country-level coordination and leadership mechanisms with the Emergency Relief Coordinator (ERC). This must then be approved by the IASC at global level.

Whilst Clusters aim to provide more coherence in the coordination of sectoral responses, inter-cluster coordination seeks to ensure greater coordination across a multi-sectoral response. At an operational level, inter-cluster coordination strives to ensure a clearly-articulated cross-sectoral humanitarian response plan, that resources are appropriately prioritised across clusters, that cross-cutting issues (such as gender and the environment) and multi-sectoral

thematic areas are appropriately and consistently addressed, and that gaps and duplications are avoided.

Furthermore, effective inter-cluster coordination is critical in ensuring that cross-sectoral activities (such as needs assessments) are well coordinated, that resource mobilisation and advocacy strategies are consistent across all clusters, and that coherent and comprehensive transition as well as exit strategies for Clusters are commonly agreed.

An operational level inter-cluster coordination forum is usually established, chaired by the United Nations Office for the Coordination of Humanitarian Affairs (OCHA) Head of Office or his/her designate. It brings together the Cluster Coordinators as representatives of their respective Clusters and focal points for cross-cutting issues. The forum takes guidance on strategic and policy issues from the HCT and feeds back broad operational priorities and concerns to the HCT. At all times, inter-cluster coordination should be guided by and should promote the humanitarian and partnership principles.

### **Global Cluster Leads**

A Cluster Lead is the organisation that has been given the mandate by the IASC to take the lead in the Cluster approach implementation with regard to a humanitarian action specific dimension (*e.g.* Health, Shelter, Logistics). It is accountable globally to the Emergency Relief Coordinator (ERC) and in-country to the HC. Furthermore, for any IASC-defined Cluster, the designated Cluster Lead is the **provider of last resort**. This means that, where necessary – and depending on access, security, and availability of funding – the Cluster Lead must be ready to ensure the provision of services required to fulfil crucial gaps identified by the Cluster and reflected in the Humanitarian Response Plan. It represents a commitment of Cluster Leads to do their utmost to ensure an adequate and appropriate response.

The Cluster Approach operates at two levels. **At the global level**, the aim is to strengthen system-wide preparedness and technical capacity to respond to humanitarian emergencies by designating global Cluster Leads and ensuring that there is predictable leadership and accountability in all the main sectors or areas of activity. **At the country level**, the aim is to ensure a more coherent and effective response by mobilising groups of agencies, organisations, and NGOs to respond in a strategic manner across all key sectors or areas of activity, each sector having a clearly designated lead, as agreed by the HC and the HCT. The HC – with the support of OCHA – retains responsibility for ensuring the adequacy, coherence, and effectiveness of the overall humanitarian response and is accountable to the ERC.

Cluster Leads in-country are accountable to the HC for facilitating a process at the sectoral level aimed at ensuring the following:

- Inclusion of key humanitarian partners.
- Establishment and maintenance of appropriate humanitarian coordination mechanisms.
- Coordination with national/local authorities, State institutions, local civil society and other relevant actors.
- Participatory and community-based approaches.
- Attention to priority cross-cutting issues.
- Needs assessment and analysis.
- Emergency preparedness.
- Planning and strategy development.
- Application of standards.
- Monitoring and reporting.
- Advocacy and resource mobilisation.

- Training and capacity building.
- Provision of assistance or services as a last resort.

## **Cluster Activation**

Under the Transformative Agenda, IASC Principals agreed that activation of Clusters must be more strategic, less automatic, and time limited than what was previously observed. HCs should only recommend their activation when there is an identified gap in the enabling environment warranting their activation. It should be noted that 1) formal activation of Clusters may be difficult in circumstances where the government capacity is constrained; 2) to ensure that clusters continue to operate only whilst they are strictly needed, plans to deactivate and transition Clusters should be prepared as soon as possible after activation; building the capacity of local partners and government should be an objective from the outset.

The criteria for cluster activation are met when:

- Response and coordination gaps exist due to a sharp deterioration or significant change in the humanitarian situation.
- Existing national response or coordination capacity is unable to meet needs in a manner that respects humanitarian principles due to the scale of need, the number of actors involved, the need for a more complex multi-sectoral approach, or other constraints on the ability to respond or apply humanitarian principles.

The procedure for activating a Cluster or Clusters is as follows:

1. The RC/HC and Cluster Leads Agencies (CLAs), supported by OCHA, consult national authorities to establish what humanitarian coordination mechanisms exist, and their respective capacities.
2. Global CLAs are alerted by their country representatives and OCHA, prior to the UN Country Team (UNCT)/HCT meeting to discuss activation, to ensure they are represented at the meeting.
3. The RC/HC, in consultation with the UNCT/HCT, determines which Clusters should be recommended for activation, assisted by analysis of the situation and preparedness planning. In each case, the decision should be based on the criteria above-mentioned.
4. The RC/HC, in consultation with the UNCT/HCT, selects CLAs based on agencies' coordination and response capacity, operational presence, and ability to scale-up. The selection of CLAs ideally mirrors global arrangements; but this is not always possible and sometimes other organizations are in a better position to lead. Under the IASC Transformative Agenda, CLAs were encouraged to consider developing a clearly defined, agreed, and supported sharing of Cluster leadership with NGOs wherever feasible.
5. The RC/HC writes to the ERC, following consultation with the HCT, outlining the recommended Cluster arrangements, suggesting CLAs, and explaining why particular Clusters need to be activated. Where non-Cluster coordination solutions have been agreed upon as well, these are also described.
6. The ERC transmits the proposal to the IASC Principals for approval within 24 hours and informs the RC/HC accordingly. The Principals may ask the IASC Emergency Directors Group to discuss in more detail, if necessary.
7. The ERC writes to the RC/HC to confirm the endorsement of activation of the suggested Clusters and/or provide feedback from the IASC Principals.
8. The RC/HC informs relevant partners when decisions on Clusters and CLAs are approved.

The IASC Transformative Agenda states that Clusters will be professionally managed by dedicated, trained, and experienced Cluster Coordinators, that information management will

be prioritised, and that resources will be pooled in order to enhance the collection and analysis of data on the progress and impact of Cluster activities.

## Cluster Functions

<b>1. To support service delivery by:</b>	<ul style="list-style-type: none"><li>• Providing a platform that ensures service delivery is driven by the Humanitarian Response Plan and strategic priorities.</li><li>• Developing mechanisms to eliminate duplication of service delivery.</li></ul>
<b>2. To inform the HC/HCT's strategic decision-making by:</b>	<ul style="list-style-type: none"><li>• Preparing needs assessments and analysis of gaps (across and within Clusters, using information management tools as needed) to inform the setting of priorities.</li><li>• Identifying and finding solutions for (emerging) gaps, obstacles, duplication, and cross-cutting issues.</li><li>• Formulating priorities on the basis of analysis.</li></ul>
<b>3. To plan and implement Cluster strategies by:</b>	<ul style="list-style-type: none"><li>• Developing sectoral plans, objectives and indicators that directly support realisation of the overall response's strategic objectives.</li><li>• Applying and adhering to common standards and guidelines.</li><li>• Clarifying funding requirements, helping to set priorities, and agreeing Cluster contributions to the HC's overall humanitarian funding proposals.</li></ul>
<b>4. To monitor and evaluate performance by:</b>	<ul style="list-style-type: none"><li>• Monitoring and reporting on activities and needs.</li><li>• Measuring progress against the Cluster strategy and agreed results.</li><li>• Recommending corrective action where necessary.</li></ul>
<b>5. To build national capacity in preparedness and contingency planning.</b>	
<b>6. To support robust advocacy by:</b>	<ul style="list-style-type: none"><li>• Identifying concerns and contributing key information and messages to HC and HCT messaging and action.</li><li>• Undertaking advocacy on behalf of the Cluster, its members, and affected people.</li></ul>

The Cluster Lead, in addition to its responsibilities as provider of last resort, supports the Cluster six core functions.

## The Logistics Cluster

The [Logistics Cluster](#) is one of 11 humanitarian Clusters established by the Inter-Agency Standing Committee (IASC) following the Humanitarian Reform and the ulterior Transformative Agenda. The “[Cluster Approach](#)” aims to strengthen system-wide preparedness and technical capacity to respond to humanitarian emergencies by ensuring coordination, predictable leadership, and accountability across the main technical sectors of humanitarian response (e.g. logistics, health, shelter).

## **The Logistics Cluster Structure**

The Logistics Cluster is a community of partners collaborating to overcome logistics constraints and improve the overall humanitarian logistics response. The Logistics Cluster governance is steered by its partner organisations at both global and country-level, supported by dedicated support teams, and led by the appointed Cluster Lead Agency (CLA).

The [World Food Programme \(WFP\)](#) was designated by the IASC as the Logistics Cluster lead agency at the global level and is accountable to the Emergency Relief Coordinator for its performance. As such, WFP hosts the Global Logistics Cluster Support Team in its headquarters in Rome, Italy and facilitates its activities through the allocation of necessary resources at global and local level – these resources are contingent on funding provided by donors to the Logistics Cluster operations. WFP also acts as provider of last resort for common logistics services.

Composed by representatives of the CLA and partner organisations appointed at global level during the Global Logistics Meetings (GLM) for a two-year mandate, the [Strategic Advisory Group \(SAG\)](#) is the Logistics Cluster steering body whose members represent and report to the entire community of partners. The SAG notably provides strategic support and guidance to the Global Logistics Cluster Support Team and may establish ad hoc working groups to develop specific aspects related to partnerships. A local SAG may also be appointed by partners at country-level when deemed relevant.

Lastly, the Logistics Cluster activities are supported by dedicated humanitarians active at both global and country level:

## **Global Logistics Cluster Support Team**

The permanently active support structure that drives, together with partners, the Logistics Cluster strategy implementation globally and is accountable for its results. It fosters, develops, and maintains partnerships to strengthen the community of partners the Logistics Cluster is based upon and oversees the organisation of global events. Furthermore, the Global Logistics Cluster Support Team also provides guidance, support, and surge capacity to Logistics Cluster activities in-country, reinforcing the capacity of staff on the ground.

## **Country Logistics Cluster Support Team**

At a country level, the Logistics Cluster is a temporary coordination mechanism activated by the IASC and accountable to the Humanitarian Coordinator through the CLA. The Logistics Cluster Support Team coordinates the Logistics Cluster activities in-country, notably by convening humanitarian actors operating locally and facilitating the logistics coordination and information management. Support provided varies in nature and scale depending on each operation’s needs. The Country Logistics Cluster Support Team is hosted and resourced by the appointed country CLA and may benefit from partners secondment. Where needed, the Logistics Cluster support team also facilitates access to common logistics services provided by its partners and manages the prioritisation of requests to this service through jointly



established criteria.

## **The Logistics Cluster Activities**

The Logistics Cluster is a community of partners. Its purpose is to support global, regional, and local actors to alleviate logistics constraints impeding the delivery of humanitarian assistance to people in need around the world. **Before crises**, it strengthens humanitarian response capacity, especially in high-risk countries and regions. **In crises**, where local capacities have been exceeded, it provides leadership, coordination, information management, and operational services. **After crises**, it evaluates the response, identifies areas for improvement, shares good practices and solutions, and invests in learning and preparedness for future emergencies.

The Logistics Cluster work is divided into four overarching interconnected pillars:

- **Partnership Base**
- **Standards and Policy**
- **Strengthening Response Capacity**
- **Operational Support**

They all comprise a broad set of activities – led both by partners and the support teams – that may be found in the Global Logistics Cluster Strategy Implementation Plan.

These activities rest upon core values the Logistics Cluster abide by at any given moment:

### **Collaboration**

The Logistics Cluster is a partnership mechanism with the ambition to consolidate its existing network, further expand it to include new actors, and make it more representative at global, regional, and local level. Its partners are committed to jointly work towards collective outcomes and use the Logistics Cluster as a platform to collaboratively address common issues and steer its strategic orientation.

### **Professionalism & Agility**

The Logistics Cluster serves the humanitarian community as a whole. It is guided by locally identified priorities and focuses on addressing evidence-based needs through operational and preparedness activities. The Logistics Cluster strives to enhance the humanitarian logistics efficiency by learning from the past, leveraging technology and innovations, and supporting operational agility in a perpetually changing humanitarian environment.

### **Localisation & Sustainability**

The Logistics Cluster is committed to foster and support a localised response capacity. When operating in-country, it provides tailored solutions geared towards minimising disruption of local markets and promoting local resilience. Furthermore, the Logistics Cluster encourages a sustainable approach to humanitarian response and generally endeavours to apply lasting solutions, both for the communities and the environment.

### **Accountability**

The Logistics Cluster is accountable to affected populations through its partners, in compliance with the humanitarian principles. It is further accountable to the humanitarian and national leaderships through the lead agency as defined by the IASC guidelines. All Logistics Cluster

plans, strategic decisions, and prioritisations are made transparently by and for its partners.

## The Logistics Cluster Strategy

[The 2022 – 2026 Logistics Cluster strategy](#) sets out the collective commitment of its community of partners around a joint mission and vision, to be achieved through common objectives, and supported by shared values. It shall be used to guide and prioritise the Logistics Cluster activities and initiatives at the global and country level, as well as to plan and secure resources for them to be undertaken. Through this document, the Logistics Cluster community re-affirmed its partnership-oriented identity and its willingness to position collaboration at its core.

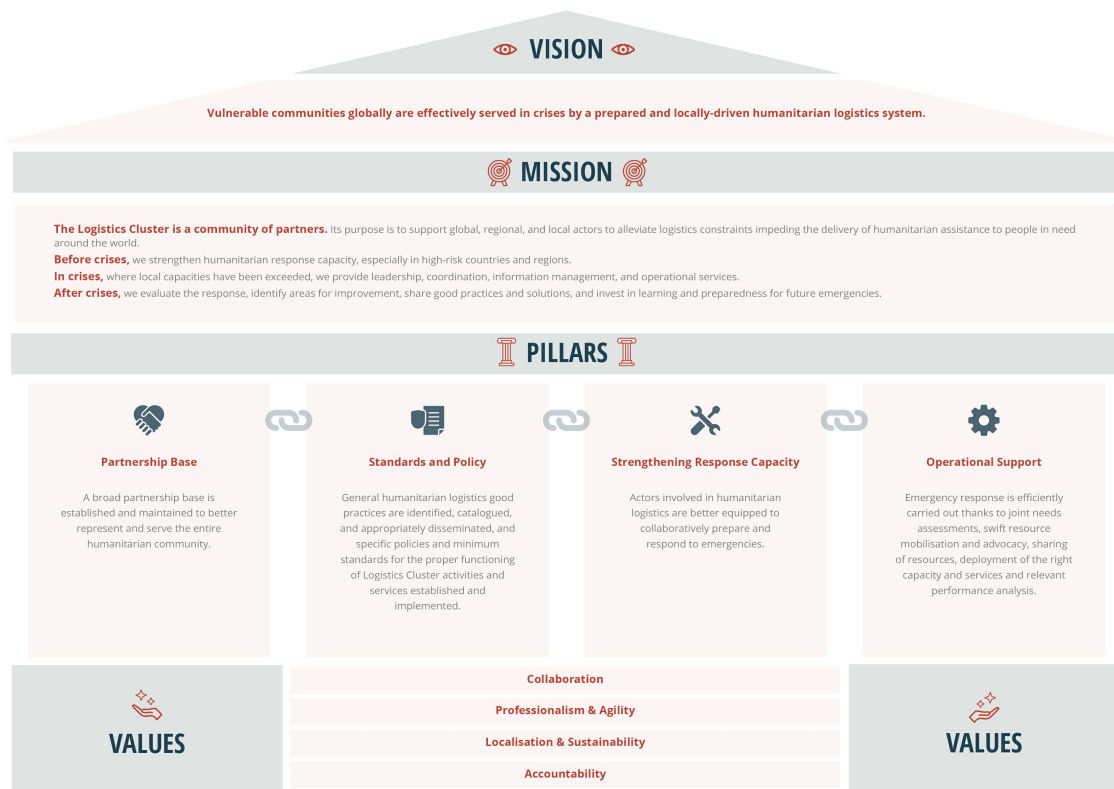

## Humanitarian Architecture Tools and Resources

### Sites and Resources

- [Emergency Disaster Database](#) - Contains essential data on all disaster events occurring in the world from 1900 to present, with country and disaster profiles.
- [Humanitarian Aid department of the European Commission](#) (ECHO)
- [International Crisis Group](#) - An NGO working to prevent and resolve conflict, its website has comprehensive information about current conflicts around the world.
- [IRIN – Integrated Regional Information Networks](#) - Useful country profiles for sub-Saharan Africa, the Middle East and Central Asia with daily and weekly news updates and much more vital information.
- [MapAction](#) - Provides accurate, up-to-date maps showing the location of groups of affected people, passable routes, which medical facilities are functioning.
- [USAID Bureau for Humanitarian Assistance](#) (BHA)

- [UK Foreign Commonwealth Development Office](#)
- [ReliefWeb](#) - Main United Nations humanitarian coordination website, with daily news about complex emergencies and humanitarian relief programmes worldwide. Most major aid agencies post reports here during an ongoing emergency.
- [Logistics Cluster](#)
- [Log:ie](#)
- [Logistics Capacity Assessments](#)
- [IASC Transformative Agenda](#)
- [IASC – Guidance note on using the cluster approach to strengthen humanitarian response \(2006\)](#)
- IASC – Reference Module for Cluster Coordination at the Country Level (2015) [English](#), [French](#), [Spanish](#))
- [United Nations DMTP \(1997\) Disaster Management Ethics](#)
- [ICRC \(2004\) What is humanitarian law?](#)
- [United Nations Integrated Mission Planning Process \(IMPP\) guidelines](#)
- [UN Development Group](#)
- [NGO Branch - UN Department of Economic and Social Affairs](#)

## Finding Cargo Dimensions

### Measuring Cargo for Transport and Storage

Measuring cargo for storage and transportation requires planners to imagine how those cargo items will realistically occupy space. Though as certain volume of liquid may be contained in a cylinder, the physical cylinder itself will still require additional "real" volumetric space. Real used volumetric space can always be envisioned as a measure of:

#### Length (l) x Width (w) x Height (h)

Due to the nature of storage facilities and transport facilities, it is helpful to imagine a box around any not cubic object, with edges at the longest and tallest points. The length of those imaginary edges will be used to plan volume for storage and transport.

**Unit Type**

**"Real" Volumes for Storage and Transport**

**Boxes** To find the volume of regular boxes, multiply the width, length and height of the box along the outer edges.

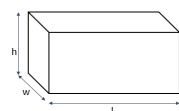

**Unit Type**

**"Real" Volumes for Storage and Transport**

**Cylinders** Though there's a formula for determining liquid volume in a cylinder, the volume for storage and transport is measured by the maximum length of it's edges.

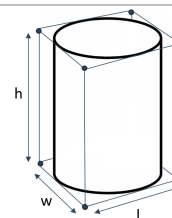

**Stacked or Nested Cargo** If cargo will be shipped or stored stacked or "nested", measure the volume of all anticipated cargo items as they will ultimately be shipped or stored, nested into each other or stacked on top of each other. Do not account for the size of each individual unit.

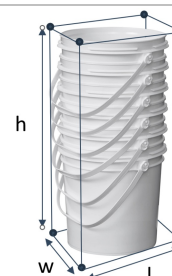

**Irregular Shapes** The volume needs of irregular shapes will vary. Unless irregular cargo items are stacked in a pile, planner may need to view the total volume used to properly store or transport an irregular shaped item.



**Generic Relief Items**

A generic list of volumes per common relief item can be found in the below table\*:

Item	Estimated Weight (Kilogram)	Estimated Volume (Cubic Meters)
Blankets (Bale of 20)	25 - 30	0.15 - 0.2
Body Soap (Carton of 50)	10	0.02
Buckets (Nested Stack of 50)	50	0.4
Cement (50 kg bag)	50	0.04
Empty Jerry Can (10 Litre)	0.5	0.01 - 0.02

<b>Item</b>	<b>Estimated Weight (Kilogram)</b>	<b>Estimated Volume (Cubic Meters)</b>
<b>Keep Cool Box</b>	<b>2 - 5</b>	<b>0.025 - 0.075</b>
<b>Latrine Slab</b>	<b>12</b>	<b>0.4</b>
<b>Laundry Soap (Carton of 50)</b>	<b>10</b>	<b>0.018</b>
<b>Mosquito Net (Bale of 50)</b>	<b>22 - 28</b>	<b>0.1 - 0.2</b>
<b>Oral Rehydration Salts (ORS) (Carton of 1,000 Sachet)</b>	<b>20</b>	<b>0.05</b>
<b>Ready to Use Therapeutic Feeding (RUTF) (Carton of 150 Sachet)</b>	<b>15</b>	<b>0.02</b>
<b>Sack of Grain (50 kg sack)</b>	<b>50</b>	<b>0.07 - 0.09</b>
<b>Sleeping Mat (Bundle of 25)</b>	<b>20</b>	<b>0.15</b>
<b>Tarpaulin (4 x 6 meter sheet) (Bale of 5)</b>	<b>23</b>	<b>0.025</b>
<b>Tin of Vegetable Oil (1 Litre)</b>	<b>1</b>	<b>0.001</b>
<b>Zinc Sheeting (Bundle of 20)</b>	<b>35</b>	<b>0.025</b>
<b>Dry Sand (loose large grained - dense fine grained)</b>	<b>1,450 - 1,850</b>	<b>1</b>
<b>Dry Gravel</b>	<b>1,500 - 1,700</b>	<b>1</b>

*\*Actual items obtained from local or international sources may vary in volumes and weights. Understanding the specific storage needs might involve obtaining the volumetric measurements and all special handling needs of all related relief items from either a supplier or a central distribution warehouse.*

## **Cargo Dimension Calculator**

## **Cargo Dimension Calculator**

---

### **Unit Converter Tool**

Use the below to switch between different units of measure.

---