

Electrical Power Generation

In general, energy can be defined as anything that has "the potential for causing changes". The most common definition of energy is the work that a certain force (gravitational, electromagnetic) can do. Energy is conserved, meaning that it cannot be created or destroyed, but only converted from one form into another; for instance, a battery converts chemical energy into electrical energy.

The aim of this is guide is to guide users on how to transform and use electric energy and electric power used for equipment and devices needed in the humanitarian interventions, including; understand basic electric concepts, knowing how to properly size installations, and how to efficiently manage electrical installations.

Common Terms in Power Generation

AC	Short for Alternating Current.
-----------	--------------------------------

DC	Short for Direct Current.
-----------	---------------------------

Electrons	Small charged particles that exist as part of the molecular structure of materials.
------------------	---

Free electron	An electron that is easily separated from the nucleus of the atom to which it belongs.
----------------------	--

Conductors	Bodies that possess free electrons (metals, for example, but also the human body and the earth).
-------------------	--

Insulators	Bodies that do not possess free electrons (e.g., glass, plastic and wood).
-------------------	--

Voltage (U)	The difference in charge between two points.
--------------------	--

Current (I)	The rate at which charge is flowing.
--------------------	--------------------------------------

Resistance (R)	A material's tendency to resist the flow of charge (current).
Circuit	A closed loop that allows charge to move from one place to another.
Resistor	Any material that allows electrical energy to be converted to thermal energy.
Overload	Additional power available for a short amount of time.
VRLA Battery	Short for Valve Regulated Lead Acid Battery.
Absorption voltage Range	The level of charge that can be applied without overheating the battery.
Float voltage Range	The voltage at which a battery is maintained after being fully charged.
Distribution Panel	This is a circuit breaker and contains many electrical circuits. Using this, a circuit can be turned on or off.
Circuit Breakers and Fuses	These protect wires from overheating and are found in the distribution panel box. When there is an overload, that is, too much current flowing, the fuses will blow or the circuit breakers will trip.
Switches	Switches can energise circuits, that is, they allow a current to flow through. If carelessly used, these can cause damage to a person and to equipment. Receptacles connect the appliances to a circuit.

Grounding/earthing connecting metal parts of electric appliances to earth.

(W) Short for Watt, the Power unit measure.

(Wh) Short for Watt-hour, the Energy unit measure

(V) Short for Volts, the Voltage unit measure

(A) A Short for Ampere, the Electrical Current unit measure

Comparison of UK-US Terminology

For the purpose of this guide US terminology is more frequently used.

UK	US
2-way lighting, switch	Switch 3-way lighting, switch
Cooker	Range
Distribution board	Distribution panel, breaker panel
Earth, earthing	Ground, grounding
Fitting	Fixture
Residual current device (RCD)	Ground fault circuit interrupter (GFCI)
Skirting board	Baseboard
Strapper	Traveler

Electrical Basics

An electric current is a flow of electric charge in a circuit - the flow of free electrons between two points in a conductor. These free electrons in motion is what constitutes electrical energy. Electricity production consists of forcing electrons to move together in a conducting material by creating an electron deficit on one side of the conductor, and a surplus on the other.

The device that produces this imbalance is called a generator. The terminal on the surplus side is marked +, that on the deficit side -.

When a load is connected to the generator's terminals, the generator pushes electrons: it absorbs the positive charged particles and sends back the negatively charged particles. In a circuit, the electrons circulate from the - terminal to the + terminal.

To be able to use electrical equipment properly and safely it is important to understand electricity works. It is vital to understand the three basic building blocks required to manipulate and utilise electricity - voltage, current, and resistance - and how the three relate to each other.

Electrical Charge

Electricity is the movement of electrons. Electrons create charge, which are harnessed to produce power. Any electrical appliance - a light-bulb, a phone, a refrigerator - are all harnessing the movement of the electrons to work. The three basic principles for this guide can be explained using electrons, or more specifically, the charge they create:

- **Voltage** - The difference in charge between two points.
- **Current (Ampere)** - The rate at which any given charge is flowing.
- **Resistance** - A material's tendency to resist the flow of charge (current).

These values describe the movement of charge, and thus, the behaviour of electrons.

A **circuit** is a closed loop that allows charge to move from one place to another. Components in the circuit allows to control this charge and use it to do work.

Electric Measurements

- **Power** - The energy consumed by the load.
- **Energy** - The amount of electricity consumed or produced during a given period of time.

Electric Potential Difference (Voltage)

Voltage (U) is defined as the amount of potential energy between two points on a circuit. This difference in charge between the + and - poles in a generator is measured in volts and is represented with the letter "V". Sometimes voltage can be called "electric pressure," an appropriate analogy because the force provided by electric potential difference to electrons passing through a conductive material can be compared to water pressure as water moves through a pipe; the higher the volts, the greater the "water pressure".

The available energy of the free electrons in motion is what constitutes electrical energy. Electricity production consists of forcing the electrons to move together through a conducting material by creating an electron deficit on one side of the conductor, and a surplus on the other. The terminal on the surplus side is marked (+), that on the deficit side (-).

Voltage is determined by the distribution network. For example, 220 V between the terminals of most electrical outlets, or 1.5V between the terminals of a battery.

Electrical Current

An Electrical Current (I) is the flow of free electrons between two points in a conductor. As electrons move, an amount of charge moves with them; this is called current. The number of electrons that are able to move through a given substance is governed by the physical properties of the substance itself conducting the electricity - some materials allow current to move better than others. Electrical current (I) is expressed and measured in Amperes (A) as a base unit of electrical current. Typically, when working with electrical equipment or installations, current is usually referred to in amperes. If volts (V) can be compared to the water pressure of water passing through a pipe, amperes (A) can be compared to the overall volume of water capable of flowing through the pipe at any given moment.

The motion of the free electrons is normally random, resulting no overall movement of charge. If a force acts on the electrons to move them in a particular direction, then they will all drift in the same direction.

Diagram: Free electrons in a conductive material with and without current applied.

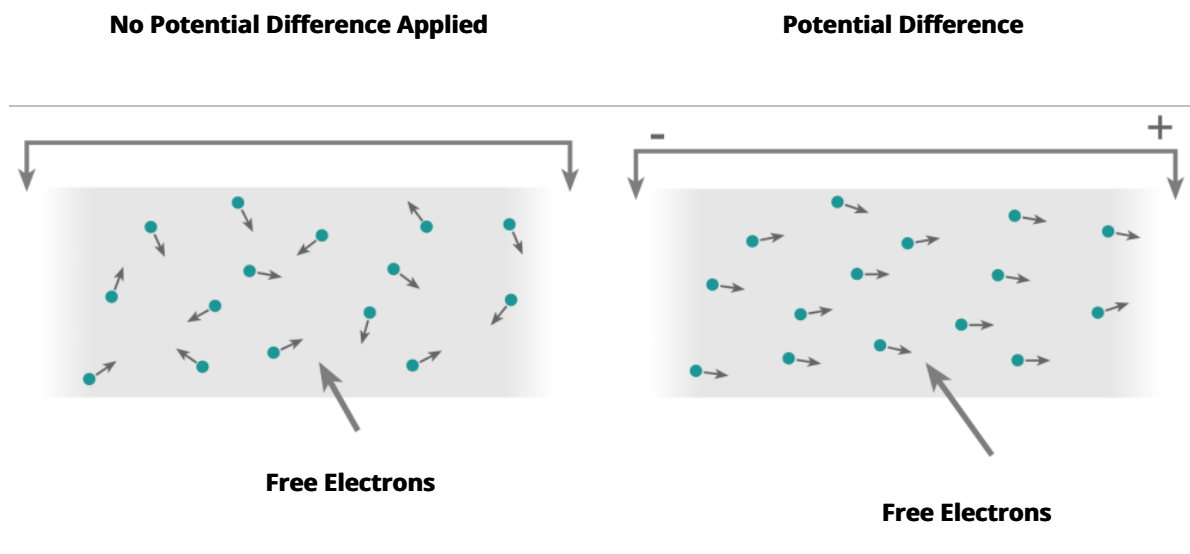

When a light bulb is connected to a generator, a certain quantity of electrons pass through the wires (filament) of the bulb. This electron flow corresponds to the current (I), and is measured in amperes (A).

Current is a function of: The power (P), The voltage (V), and the resistance (R).

$$I = U / R$$

Resistance

Sometimes electrons are held within their respective molecular structures while other times they are able to move around relatively freely. The resistance of an object is the tendency of this object to oppose to the flow of electric current. In terms of electricity, the resistance of a conductive material is a measure how the device or material reduces the electric current flowing through it. Every material has some degree of resistance; it can be very low – such as copper (1-2 ohm per 1 meter) – or very high – such as wood (10000000 ohm per 1 meter). As an analogy to water flowing through a pipe, resistance is bigger when the pipe is narrower, decreasing the flow of water.

In two circuits with equal voltages and different resistances, the circuit with the higher resistance will allow less charge to flow, meaning the circuit with higher resistance has less current flowing through it.

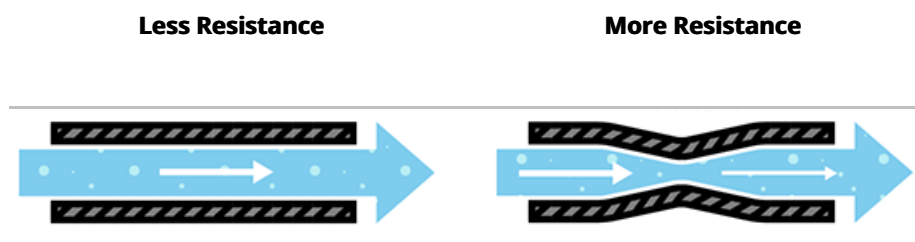

The Resistance (R) is expressed in ohms. Ohm defines the unit of resistance of “1 ohm” as the resistance between two points in a conductor where the application of 1 volt will push 1 ampere. This value is usually represented in schematics with the Greek letter “Ω”, which is called omega, and pronounced “ohm”.

For a given voltage, the current is proportional to the resistance. This proportionality, expressed as a mathematical relationship, is known as Ohm’s Law:

$$U = I \times R$$

$$\text{Voltage} = \text{Current} \times \text{Resistance}$$

For a constant voltage, increasing the resistance will reduce the current. Conversely, the current will increase if the resistance is lowered. At constant resistance, if the voltage increases, so will the current. Ohm’s Law is valid only for pure resistance, i.e., for devices that convert electrical energy into purely thermal energy. With motors, for example, this isn’t the case.

Electrical devices may have purpose-built resistors which limit the current that flows through a component, so that component is not damaged.

Resistance determined by load. For example, wire conductors with a larger cross section offer less resistance to current flow, resulting in a smaller voltage loss. Inversely, resistance is directly proportional to the length of the wire. To minimise voltage loss, a current needs the shortest possible wire with a large cross-section. (see [cabling](#) section) Note also that the kind of wire (copper, iron, etc.) also affects a cable’s resistance.

When the resistance in an electrical circuit is near zero, the current may become extremely large, sometimes resulting in what is called a "short-circuit." A short-circuit will cause an overcurrent within the electrical circuit, and can cause damage to the circuit or device.

Power

Electric power (P) is the amount of work done by an electric current in a unit of time. It represents the amount of energy consumed by a device connected to the circuit. It is calculated by multiplying the voltage by the current, and is expressed in Watts (W).

$$P = U \times I$$

$$\text{Power} = \text{Voltage} \times \text{Current}$$

The more powerful the load, the more current it draws. This calculation is useful when analysing power needs.

Power Vs. Energy

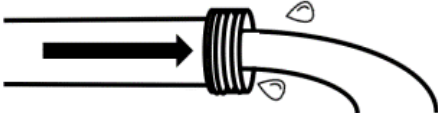
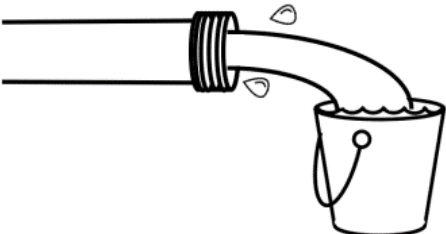
POWER	<ul style="list-style-type: none">• Watts• Kilowatts		"like the flow rate of water"
<hr/>			
ENERGY	<ul style="list-style-type: none">• Watt-hours• Kilowatt-hours		"like the water that ends up in the bucket"

Power is determined by the load.

A 40W light bulb plugged into a 220V outlet draws a current of $40/220 = 0.18A$.

Example: A 60W light bulb plugged into a 220V outlet draws a current of $60/220 = 0.27A$.

Energy Consumption

Energy consumption is the amount of electricity produced or consumed during a given period of time. This is calculated by multiplying the power of a device by the duration of its use, expressed in hours, expressed in kilowatt-hours (kWh).

Example: A 60W light that's left on for 3 hours will consume 180Wh, or 0.18kWh.

This is the unit of consumption that adds up on the electric meter to determine any **electricity bill**.

Electric energy is often confused with electric power, but they are two different things:

- Power measures capacity to deliver electricity
- Energy measures total electricity delivered

Electric energy is measured in Watt-hours (Wh), but most people are more familiar with the measurement on their electric bills, kilowatt-hours (1 kWh = 1,000-watt-hours). Electric utilities work at a larger scale and will commonly use megawatt-hours (1 MWh = 1,000 kWh).

Effects

Depending on the nature of the elements through which it passes, electric current can have several physical effects:

Effect	Description	Application Examples
Thermal Effect	<ul style="list-style-type: none">• When a current pass through a material with electrical resistivity, electrical energy is converted into thermal (heat) energy.	<ul style="list-style-type: none">• Lighting, electric heating.
Chemical Effect	<ul style="list-style-type: none">• When a current is passed between two electrodes in an ionic solution, it causes an exchange of electrons, and thus matter, between the two electrodes. This is electrolysis: the current caused a chemical reaction.• The effect can be reversed: by performing electrolysis in a container, a chemical reaction can create electrical current.	<ul style="list-style-type: none">• Current creates chemical reaction: metal refining, electroplating.• Chemical reaction creates current: batteries, storage cells.

Effect	Description	Application Examples
Magnetic Effect	<ul style="list-style-type: none"> • Electric current passing through a copper rod produces a magnetic field. • The effect can be reversed: turning an electric motor mechanically produces current. 	<ul style="list-style-type: none"> • Current produces a magnetic field: electric motors, transformers, electromagnets. • Magnetic field produces current: electric generators, bicycle dynamos.
Photovoltaic Effect	<ul style="list-style-type: none"> • When light or other radiant energy strikes two dissimilar materials in close contact produce an electrical voltage. 	<ul style="list-style-type: none"> • Solar cell to produce electricity.

Adapted from MSF

Electrical Installations and Circuits

Types of Current

Current delivering electricity to any device can come in two forms:

1. Direct Current (DC)
2. Alternating Current (AC)

When connecting any device to any circuit, it is important to know which form of current is being used.

There are devices that can convert current from one format to another, or from a higher voltage current to a lower voltage current and vice versa are universally referred to as "transformers." Any time voltage or current type is transformed, there will always be some energy loss, even if very small.

- A transformer that converts a higher voltage current to a lower voltage current is called a "step down" transformer, and works by either converting high voltage low current loads to low voltage high current loads, or by adding resistance between two circuits to limit the voltage output, resulting in lower power being received on the output side.
- A transformer that converts to a higher voltage is called a "step up" transformer, and works by converting low voltage but high currents into high voltage but low currents. A step up transformer does not add additional electrical power to the circuit, it only increases overall voltage.
- A transformer that converts a current from DC to AC is called an inverter, and physically induces an alternating current on the output side. Inverters typically consume electrical power for the conversion process, and thus are less energy efficient than other forms of

transformers.

- A transformer that converts a current from an AC to DC can be called a "battery charger" (for charging batteries) or a "power supply" (for direct powering of a radio, etc.), depending on how the conversion process works.

Direct Current (DC)

The main characteristic of a Direct Current – or DC – is that the electrons within the current always flow in the same direction, from the side with a deficit to the side with a surplus. This is the kind of current supplied via the chemical effect by batteries, or via the photovoltaic effect by solar panels. The terminals are marked + and – to show the polarity of the circuit or generator. The voltage and current are constant in time.

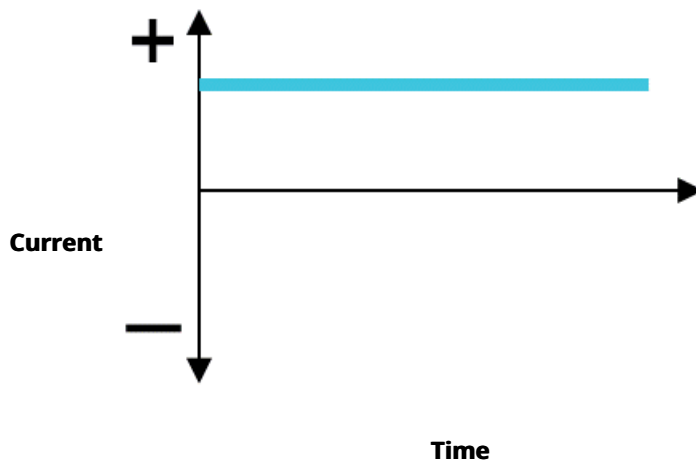

- **Advantages:** Batteries can supply DC directly and it is possible to add the sources in parallel or series.
- **Disadvantages:** In reality, the use of the batteries limits the voltage to a few volts (up to 24 volts in some vehicles). Those low voltages prevent the transportation of this type of current.

Things That Use DC Current

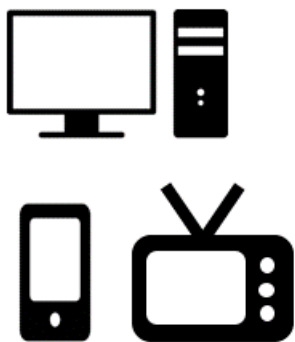

Alternating Current (AC)

In alternating current – or AC - the electrons reverse direction at a given frequency. As the current continually alternates there is no fixed + or -, but “phase” and “neutral”. Voltage and current follow a sinusoidal curve. While voltage and current continually vary between a maximum and minimum value, measurement masks this variation and shows a stable average value—such as 220V.

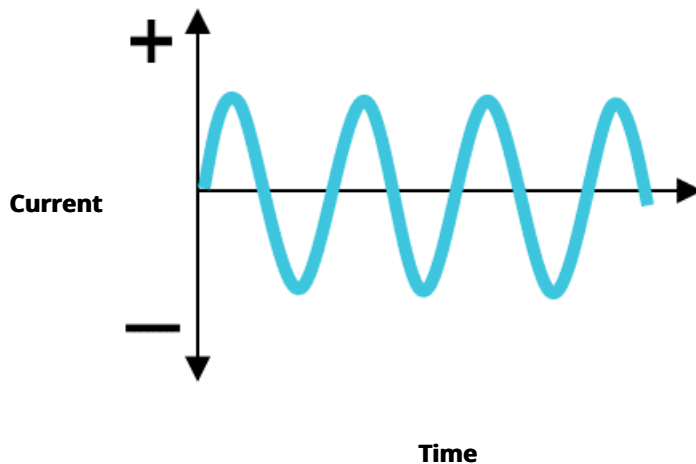

The frequency is defined as the number of sinusoidal oscillations per second:

- 50 oscillations per second in Europe (50Hz).
- 60 oscillations per second in the US (60Hz).

AC is the type of current supplied by electric utility companies because AC voltage can be increased and decreased with a transformer. This allows the power to be transported through power lines efficiently at high voltage and transformed to a lower, safer, voltage for use in businesses and residences. Therefore, it is the form of electrical energy that consumers typically use when they plug an appliance into a wall socket.

- **Advantages:** Can be transported over long distances without too much loss using high tension lines. It is easy to produce.
- **Disadvantages:** AC cannot be stored; it must be created. AC can also pose a greater health hazard for living organisms that come into contact with it.

Things That Use AC Current

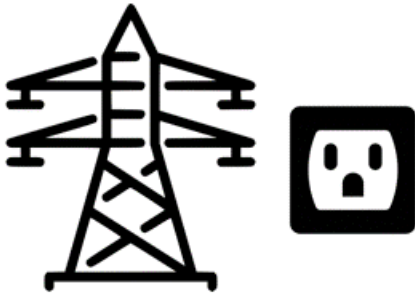

There are two types of AC:

A single-phase current is the most common type of current, and thus is usually the configuration delivered by public networks, but also by a single-phase generator. A single-phase AC is supplied via two lines (phase and neutral), usually with a 220 V voltage difference between them. Plugs can be inserted in both ways.

Because the voltage of a single-phase system reaches a peak value twice in each cycle, the instantaneous power is not constant and is mainly use for lighting and heating but cannot work with industrial motors.

A single-phase load may be powered from a three-phase distribution transformer allowing stand-alone single-phase circuit to be connected a three-phase motor, an allowing a three-phase motor to be connected to all three phases. This eliminates the need of a separate single-phase transformer.

Single-Phase

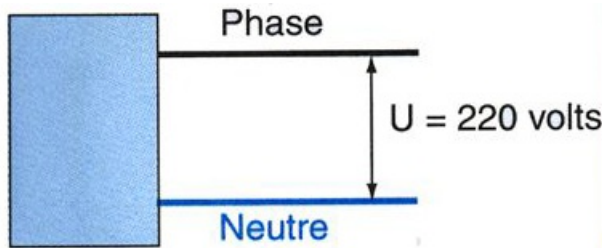

If there is an increased need for power, then consistency and balance pay a key role. Three-phase circuit is the common current configuration for electricity companies, and can also be produced with a three-phase generator. A three-phase current is the combination of three single phase currents.

To carry a given power with 3 separate single-phase cables, 9 wires are needed. To carry the same power in a three-phase cable, only 5 wires are required (3 phase, 1 neutral, 1 ground), which it is why there can be significant savings when properly planning a three-phase current. Cost savings include saving on wires, cables, and also in apparatus using or producing electricity. Three-phase motors or alternators will also be smaller than the single phase equivalents of the same power production.

Three-Phase

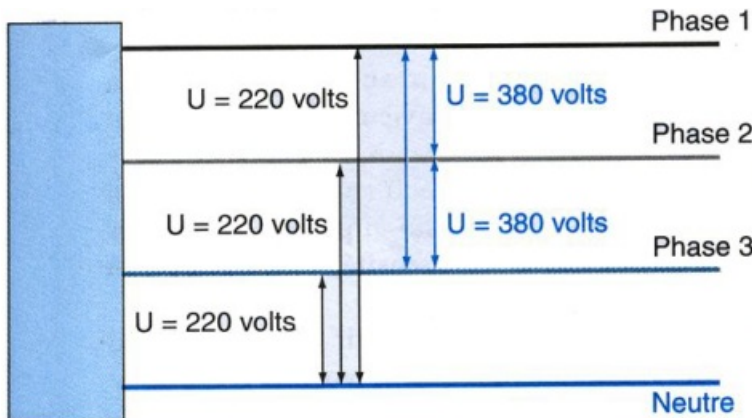

Grouping Circuit Components

In every circuit there will be resistor(s) and generator(s), the numbers of which will depend of the power requisites. Both components can be grouped depending on what is required to keep constant, the current or the voltage. There are two basic ways to group components in series or in parallel. (additional information in [connecting batteries](#) section)

The basic idea of a “series” connection is that components are connected end-to-end in a line to form a single path through which current can flow:

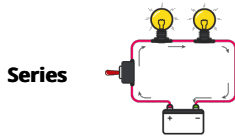

1. **Current:** The amount of current is the same through any component in a series circuit.
2. **Resistance:** The total resistance of any series circuit is equal to the sum of the individual resistances.
3. **Voltage:** The supply voltage in a series circuit is equal to the sum of the individual voltage drops.

The basic idea of a “parallel” connection is that all components are connected across each other’s leads. In a purely parallel circuit, there are never more than two sets of electrically common points, no matter how many components are connected. There are many paths for current flow, but only one voltage across all components:

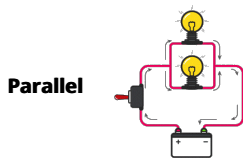

1. **Voltage:** Voltage is equal across all components in a parallel circuit.
2. **Current:** The total circuit current is equal to the sum of the individual branch currents.
3. **Resistance:** Individual resistances *diminish* to equal a smaller total resistance rather than *add* to make the total.

Cable Sizes and Wiring

What ties all the components together in an electrical system are the cables. Cables supply the power from power sources for distribution to appliances, lights and equipment. Unfortunately, the most common installation error is to under-size cables relative to the load/s or from the recharge sources.

Proper installation is primarily a matter of sizing a cable to match its task, using the correct tools to attach terminals, and providing adequate over-current protection with fuses and circuit breakers. Cable sizing is fairly simple; it is a function of the length of a cable measuring from the power source to the appliance, and the current (amperage) that will flow through it.

The longer the cable, or the higher the amperage, the bigger the cable must be to avoid unacceptable voltage losses. There should always be plenty of extra margin for safety because an appliance may actually use more current than what it is rated for because of heat, low voltage, extra load, or other factors. There’s never a performance penalty if a cable is marginally oversized; there is always a performance penalty - and possibly a safety hazard - if it’s undersized.

The ground (negative) cable is as much a part of a circuit as the positive cable; it must be sized the same. In general, each appliance should be supplied from the distribution panel with its own positive and negative cables, although lighting circuits sometimes use common supply and ground cables to feed a number of lights (in which case the supply cables must be sized for

the total load of all the lights). For 24v systems, the cables size is half that of a 12v setup. Always read product recommendations, or check with the supplier to know and understand exactly what size cable is required for the products.

To better plan and size cables, please reference the cable sizing table below:

Circuit Type											
10% Voltage Drop (Non-Critical)	3% Voltage Drop (Critical)	5A	10A	15A	20A	25A	30A	40A	50A	60A	
		0-6 m	0-2 m								
6-9 m	2-3 m										
9-15 m	3-4.5 m										
15-19 m	4.5-6 m										
19-24 m	6-7.5 m										
24-30 m	7.5-9 m										
30-40 m	9-12 m										
40-51 m	12-15 m										
Cable Length in Meters	51-61 m										
	18-21 m										
	21-24 m										

Circuit Type

	10% Voltage Drop (Non- Critical)	3% Voltage Drop (Critical)	5A	10A	15A	20A	25A	30A	40A	50A	60A
24-27 m											
27-30 m											
30-33 m											
33-37 m											
37-40 m											













The above cable sizing table is used by running across the top row until the column with the relevant amperage is found, and then moving down the left-hand column until the row with the relevant distance is reached. Wire sizes are denoted by colour coding.

Gauge:

A common way for referencing a cable size is its "gauge." The American Wire Gauge (AWG) is used as a standard method of denoting wire diameter, measuring the diameter of the conductor - measured as only the bare wire with the insulation removed. AWG is sometimes also known as Brown and Sharpe (B&S) Wire Gauge.

Below is a conversion chart from AWG/B&S to mm². This table gives the closest equivalent size cross references between metric and American wire sizes. In Europe and Australia, wire sizes are expressed in cross sectional area in mm².

Standard	Unit												
AWG	0000	000	00	0	1	2	4	6	8	10	12	14	16

Standard	Unit												
Diameter (mm)	11.68	10.40	9.27	8.25	7.35	6.54	5.19	4.11	3.26	2.59	2.05	1.63	1.29
Cross Section (mm ²)	107.1	84.9	67.5	53.5	42.4	33.6	21.2	13.3	8.4	5.3	3.3	2.1	1.3
Colour Code													

A printable guide to [sizing cables can be downloaded here](#).

Title

Guide - Cable Sizing Chart

File



Colour Coding

While it is possible to use the same cables for AC and DC circuits, it is advisable to use different coloured cables between the two types of currents, both to increase handling safety but also to make installation and repair work much faster. If existing appliances or installations have colours, logistics managers may consider replacing or standardising them by re-colour coding the wires with an external paint or marking in a method that makes sense.

A general colour code for AC looks like:

- **Neutral:** Blue.
- **Phase:** Brown or black.
- **Ground:** Green/yellow.

The neutral and the phase are the two connections for the electricity, the ground is for safety.

















Colour code for DC (direct current, battery):

+ = red or blue











- = black or brown

Many differing international standards apply however. Please reference the below table for colour coding of different countries and regions around the world.

Standard Wire Colours for Flexible Cable
(e.g. Extension Cords, power cords and lamp cords)

Region or Country	Phases	Neutral	Protective Earth/Ground
European Union (EU), Argentina, Australia, South Africa			
Australia, New Zealand	 	 	
Brazil	 		
United States, Canada	 (brass)	 (silver)	 (green) or  (green/yellow)

Standard Wire Colours for Fixed Cables
(e.g. In/On/Behind the wall wiring cables)

Region or Country	Phases	Neutral	Protective Earth/Ground
Argentina	  		
European Union and UK	  		

UK Prior to March 2004



(formerly)

Any colours other than:

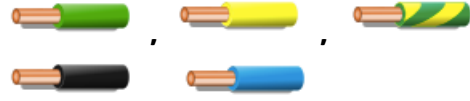

(since 1980)



(since 1980)

Australia, New Zealand Recommended for single-phase:

or



Recommended for multi-phase:



bare conductor, sleeved at terminations (formerly)

Brazil



South Africa

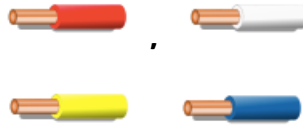

or



bare conductor, sleeved at terminations

India, Pakistan



United States



(green)

(120/208/240V) (brass)



(120/208/240V)



(Silver)

bare conductor



(277/480V)

(277/480V)

(ground or isolated ground)

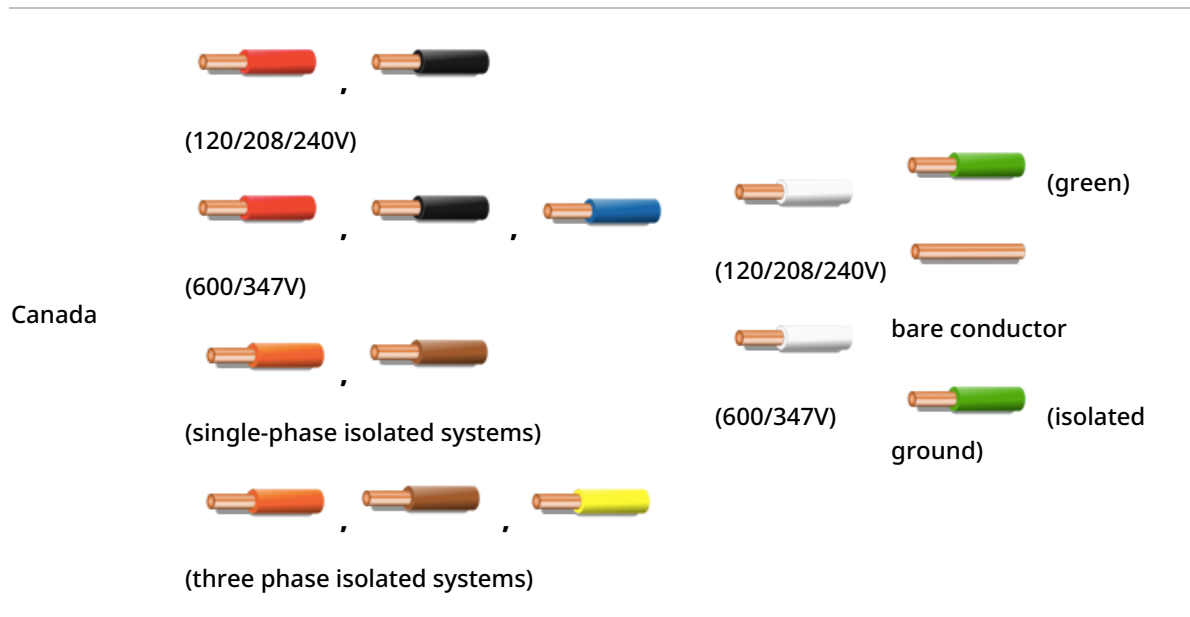

Important points to note when wiring:

- All circuits should be removed from the floor and be as high as possible with no connections in or near water or damp areas.
- All cable lug connections should be securely crimped to the wire termination with a band, and not soldered in place.
- Tinned cable – copper wire that has been coated with a thin layer of tin to prevent corrosion - It is preferable to use where possible in a marine environment or near salt water.
- Never tap into or splice existing circuits when installing new equipment; run a properly sized new duplex cable (positive and negative cable in a common sheath) from the distribution panel (or a source of power) to the appliance.
- It is recommended to label all cables at both ends, and to an updated wiring plan to aid in future troubleshooting. Copies of the wiring plans can be even be stored in locations such as the fuse box or distribution box so that future users can reference them.
- Each circuit should have an independent ground cable, and all the ground cables should eventually be tied back to a common ground point/busbar.
- Unless in a conduit, cables should be physically supported at least every 450mm.
- Although black is often used for DC negative, it is also used for the live wire in AC circuits in the USA. That means there is potential for dangerous confusion. DC and AC wiring should be kept separate; if they have to be run in the same bundle, one or the other should be in a sheath to maintain separation and ensure safety.

Grounding and Protective Devices

Protective Devices

Protective devices for electrical circuits ensure that a high current cannot flow under faulty conditions, protecting the installation and equipment and preventing injury and harm to persons handling or in the near vicinity of equipment. Overcurrent protection is assured through physically detaching the power supply in a circuit, which removes fire hazards and risk of electrocution.

Protective devices might include:

- Fuses.
- Miniature Circuit Breakers (MCBs).
- Residual Current Devices (RCDs).
- Residual Current Breakers with Overcurrent (RCBOs).

All of the aforementioned devices protect users and equipment from faulty conditions in an electrical circuit by isolating the electrical supply. Fuses and MCBs only isolate the live feed; while RCDs and RCBOs isolate both the live and neutral feeds. It is essential that the appropriate circuit protection is installed to ensure an electrical installation is safe.

Fuses

A fuse is a very basic protection device used to protect the circuit from overcurrent. It consists of a metal strip that liquefies when the flow of current through it surpasses a pre-defined limit. Fuses are essential electrical devices, and there are different types of fuses available based on specific voltage and current ratings, application, response time, and breaking capacity.

The characteristics of fuses like time and current are selected to give sufficient protection without unnecessary disruption.



Miniature Circuit Breaker (MCB)

An MCB is a modern alternative to fuses, and are usually centrally located in buildings – usually called a “fuse box” or “breaker box”, or attached to specific equipment. They are just like switches, turning off when an overload is detected in the circuit. The basic function of a circuit breaker is to stop the flow of current once a fault has occurred. The advantage of MCBs over fuses is that if they trip, they can be reset without having to replace the whole MCB. MCBs can also be calibrated more precisely than fuses, tripping at exact loads. Circuit breakers are available in different sizes from small devices to large switch gears which are used to protect low current circuits as well as high voltage circuits.



Residual Current Device (RCD)

Residual Current Devices (or RCDs) are designed to detect and disconnect supply in the event of a small current imbalance between the live and neutral wires at a pre-defined value - typically 30mA. RCDs can detect when a live conductor touches an earthed equipment case, or when a live conductor is cut through; this type of fault is potentially dangerous and can result in electric shocks and fires.

An RCD does not give safety against a short circuit or overload in the circuit. It cannot detect - for example - a human being accidentally touching both conductors at the same time. An RCD cannot replace a fuse in function.

RCDs can be wired to protect a single or multiple circuits - the advantage of protecting individual circuits is that if one circuit trips, it will not shut down the whole building or distribution system, just the protected circuit.



Residual Current Breaker with Overcurrent (RCBO)

An RCBO combines the functions of a MCB and an RCD in one unit. RCBOs are a safety device which detects a problem in the power supply and is capable of shutting off in 10-15 milliseconds.

They are used to protect a particular circuit, instead of having a single RCD for the whole building.

These devices are testable as well as are able to be reset. A test button securely forms a tiny leakage condition; along with a reset button again connects the conductors after an error state has been cleared.



Grounding/Earthing

Uncontrolled electricity can injure or even kill humans or animals. A common and effective way to control electricity is through grounding. Grounding is a physical connection to the earth that draws electric charge safely to the ground allowing a large space for electrons to dissipate away from humans or equipment. A grounding system gives excess positive charge in electrical lines access to a negatively charged ground wires, eliminating the dangers of fire and electrocution.

Some devices may have a "ground" symbol indicating where a grounding wire should be connected.



The term "ground" refers to a conductive body, usually the earth. "Grounding" a tool or electrical system means intentionally creating a low-resistance path to the earth's surface. When properly done, current from a circuit follows this path preventing the build-up of voltage that would otherwise result in electrical shock, injury and even death. Grounding is used to dissipate the damaging effects of an electrical short, but also used to prevent damage from lightning as well.

There are two ways to ground devices:

1. **System or Service Ground:** In this type of ground, a wire called "the neutral conductor" is grounded at the transformer, and again at the service entrance to the building. This is primarily designed to protect machines, tools, and insulation against damage.
2. **Equipment Ground:** This is intended to offer enhanced protection to the people. If a malfunction causes the metal frame of a tool to become energised, the equipment ground provides another path for the current to flow through the tool to the ground.

A major aspect to grounding to be aware of: a break in the grounding system may occur without the user's knowledge. Using a ground-fault circuit interrupter (GFCI) is one way of overcoming grounding deficiencies.

In tandem with a residual current device (RCD), grounding is essential to interrupting the power supply if there is an insulation fault—for example, if a live wire comes loose and touches the metal surface outside a piece of equipment. A ground wire channels the fault current into the earth, preventing injury to people. The earth connection picks up fault currents, allowing RCDs to measure them and trip.

When grounding circuit components and appliances, the cabling should have an electrical resistance below the maximum threshold of the main service breaker:

- 100Ω for a 500mA RCD
- 167Ω for a 300mA RCD
- 500Ω for a 100mA RCD

The lower the resistance, the better a grounding system will work.

Grounding System Components

The connection between metal parts and grounding is made using a third wire in the electrical circuit. Ground wires usually have a green-yellow colour and must have the same gauge as the biggest wire used on the installation to protect.

To check if a grounding connection has been installed, look for the following points:

1. Plugs and sockets have a grounding pin.
2. Plugs with grounding pin are connected to a 3-wire network.
3. Ground wires are well connected to each other on the distribution board, normally through a grounding pad or a connecting strip in metal.
4. The grounding pad or the connecting strip is connected to the ground and this link must be done with a high-thickness wire (for example, 16mm²).
5. This wire is connected to the ground.

Ground Connecting Cables in Use:

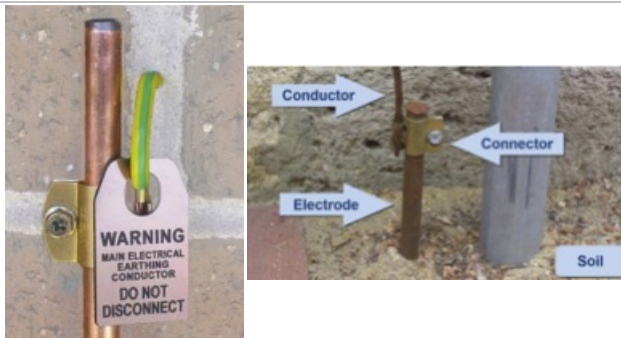

A grounding system typically consists of a grounding conductor, a bonding connector, its grounding electrode (typically a rod or grid system), and the soil in contact with the electrode. An electrode can be thought of as being surrounded by concentric rings of earth or soil, all the same thickness - each successive ring having a larger cross-sectional value and offers less and less resistance until a point is reached that it adds negligible resistance.

Dangers/Precautions

Electricity is potentially dangerous and has inherent risks, especially from a circuit failure, misuse, inexperienced handling, or negligence. The effects on humans, appliances, and other objects can be devastating. When installing an electrical circuit, extending an existing circuit, or looking for a new office or guest house it is recommended to perform a full assessment on the facility. Full assessments should ensure that the circuit can safely handle the current flow.

needed, proper protection devices exist, the circuit is grounded, and there are no potential hazards.

For equipment, the dangers of an improperly installed or secured circuit are short circuits and overloads. For people, the dangers come from insulation faults that lead to direct or indirect contact with electrical currents.

Short Circuit

A short circuit is a strong overcurrent of short duration. In single-phase systems, a short circuit occurs whenever the phase and neutral wires accidentally come into contact; in three-phase systems, this can occur when there is contact between two of the phases. For DC, a short circuit can occur when the two polarities come into contact.

Short circuits can also occur when there is a break in the insulation surrounding a cable, or when two conductors come in contact via an external conductor (example: a metal hand tool) or water bridges the connections of the lines, causing the resistance of the circuit to become close to zero and thus reaching high values ($U=RxI$) very quickly.

Physical damage can expose cables inside of insulation, while a sudden temperature increase of the conductors can cause the insulation and copper cores to melt.

Overload

An overload is caused by a weak overcurrent occurring over a long duration. Overloads can be caused by a current that is too high to be conducted through the relative diameter of the conducting cable.

There are two kinds of overload:

- Normal overloads, which can occur when a motor starts up. Normal overloads are short-lived and pose no danger.
- Abnormal overloads occur when too many appliances are connected to the same circuit or the same outlet at the same time, or when a connection terminal isn't properly tightened. These problems are common in old buildings with too few outlets, but can occur on any installation as the number of electric devices increase. The current is lower in an abnormal overload than that of a short circuit, but the results are identical: overheated wires, damaged insulation, high risk of fire.

Insulation Faults

Insulation faults are caused by damage to the insulation of one or more phase conductors. These problems can lead to electrical shocks from current-carrying lines, and if the damaged conductor touches a metal surface or casing, can cause appliance and equipment to be electrified to the touch as well.

An insulation fault can also be caused by moisture from water damage or natural humidity in walls.

These faults can be very dangerous, especially when a person comes into direct contact with the conductor, a metal casing, or a defective electrical appliance. In all cases the human body becomes part of the electrical circuit causing an electric shock.

Injury from Electrical Exposure

The damage to a human body is done by 3 factors:

- The amount of current flowing through the body.
- The pathway of the electricity entering the body.
- The duration of the body's exposure to the electricity.

The below table and image details the general response of a human body to different strengths of electrical current. The arrows show the flow of electricity from the point of entry to the nearest exit point. The blue arrow shows the flow of current through the head / heart then to ground, which is the most lethal.

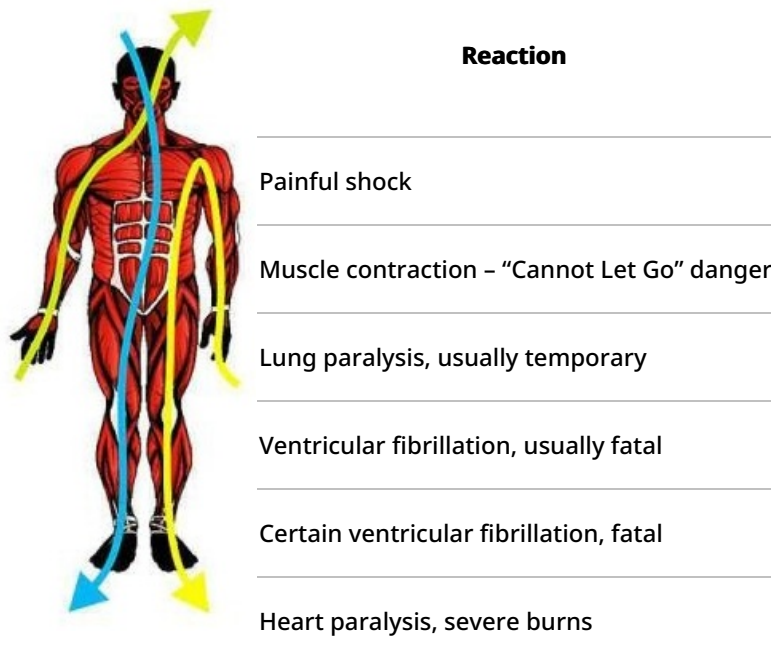

Safety Equipment

To avoid or reduce the damaging effects current can have in a human body, it is highly recommended to use protective equipment and take precautions when handling electrified circuits and equipment.

- Rubber Gloves - To prevent hands from directly making contact with the current. They must be close fitting and have an excellent grip.
- Tight Sleeves and Trouser Legs - To prevent unintentional contact or being pulled into dangerous equipment.
- Remove rings from fingers.
- Rubber Boots - To prevent the body from forming a complete conducting electrical circuit.

Electrical Hazards

If an installation is properly set up, grounded and well maintained, electrical shorts or other issues should not be a problem. If the basics of installation, handling, maintenance are neglected, several hazards can occur.







Hazards	Description	Possible Sources
Shocks	<p>Electric shock occurs when the human body becomes part of the path through which current flows.</p> <p>The direct result is electrocution. The indirect result is injury resulting from a fall or uncontrolled movement.</p>	<ul style="list-style-type: none"> • Electrical cords can cause trip hazards. • Frayed power cords are dangerous. • Overloading electrical sockets. • Damaging cords by running over them or placing heavy objects on them • Improperly modifying electrical plugs. • Overheating machinery by not having adequate ventilation. • Damaged electrical outlets. • Exposed wires. • Working close to power sources. • Overhead lines hanging low or falling. • Water dripping on live equipment.
Burns	<p>Burns can result when a person touches electrical wiring or equipment that is energised.</p>	
Arc-Blast	<p>Arc-blasts occur from high-amperage currents arcing through the air. This can be caused by accidental contact with energised components or equipment failure.</p> <p>The three primary hazards associated with an arc-blast are:</p> <ul style="list-style-type: none"> • Thermal radiation. • Pressure waves. • Projectiles. 	
Explosions	<p>Explosions occur when electricity provides a source of ignition for an explosive mixture in the atmosphere.</p>	
Fires	<p>Electricity is one of the most common causes of fires both in the home and in the workplace. Defective or misused electrical equipment is a major cause of electrical fires.</p>	

Hazard Signs

Safety signs keep persons aware of hazards. It is important to located them accordingly so persons working around the hazard can take proper precaution. They should be in visible places and include the maximum possible information about the source of and properties of the danger. In case of an incident, this information can be a valuable information.

Example of these signs include:

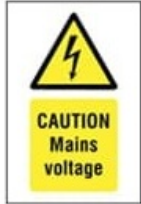

Voltage Warning Labels	Electrical Voltage Symbol	Danger of Death from Electricity Warning	Switch Off when not in Use
			
Electric Shock Warning	High Voltage Warning	Overhead Cables Warning	Live Wires Warning
			
Buried Cables Warning	Mains Voltage Warning	Danger - Do not Enter Sign	Warning - Isolate Before Removing Cover

Electrical Fires

Electricity is one of the most common causes of fire. Electrical current and the chemical reaction of fire are both methods of transferring energy; while electricity involves the movement of negatively charged electrons, a flame consists of the dispersal of both positive and negative ions. Therefore, faulty wiring for example can cause arcing and sparking that can easily become a flame if the conditions to produce a fire are present, such as oxygen, heat or any kind of fuel.

Power sources that are directly related to electrical fires can be any of the following:

- Faulty wiring.
- Overloaded devices.
- A short circuit.
- Power cord damage.
- Overloaded electrical outlets.
- Improperly installed light fixtures.

Part of avoiding an electrical fire includes properly sizing, using and maintaining the electricity system, however hazards can occur regardless and fire suppression tools should be in place. Fire extinguishers are the most reliable mean to do it, however the appropriate fire extinguisher must be used or the extinguisher itself may be ineffective.

Fire Extinguisher Classes Per Region:

American	European	UK	Australian/Asian	Fuel/Heat Source
Class A	Class A	Class A	Class A	Ordinary combustibles
Class B	Class B	Class B	Class B	Flammable liquids
	Class C	Class C	Class C	Flammable gases
Class C	Unclassified	Unclassified	Class E	Electrical equipment
Class D	Class D	Class D	Class D	Combustible metals
Class K	Class F	Class F	Class F	Kitchen Grade (Cooking oil or fat)

Electrical fires need to be put out by a non-conductive substance, unlike the water or foam found in class A fire extinguishers. If someone attempts to put out an electrical fire with something like water, there is a high risk of electrocution since water is conductive. Class C fire extinguishers use monoammonium phosphate, potassium chloride, or potassium bicarbonate, which do not conduct electricity. Another option is a class C extinguisher that contains carbon dioxide (CO₂). CO₂ is great for suppressing fires because it takes the fire's oxygen source away as well as diminishes the fire's heat since the CO₂ is cold when expelled from the extinguisher.

Prevention

Prevention is the most effective measure to mitigate risk. Some of these preventive measures planners can take when working around electricity include:

- Never plug appliances rated at 230 V into an 115V electrical socket.
- Place all lamps on level surfaces and away from things that can burn.
- Use bulbs that match a lamps' rated wattage.
- Do not overload an electrical outlet by connecting several devices into a single receptacle using any device.
- Do not tug or pull any electrical cords.
- If an outlet or switch is feeling warm, shut off the circuit and call an electrician to check the system.
- Follow manufacturer's instructions for plugging a device into an electrical outlet.
- Avoid running extension cords under carpets or across doorways.
- Do not connect the cord of an old electrical device to a newer cord.
- Replace and repair frayed or loose cords on all electrical devices.
- Keep all electrical appliances away from water.
- Contact electricity authority if any damage done to overhead cables, outdoor panel boxes, or trees touching high voltage lines is seen.
- Review architectural drawings and/or contact electrical authorities before doing any work involving digging.
- Take heed to all warning signs indicating electrical hazards.

- Ensure a fire extinguisher is placed where the likelihood of a hazard occurring is great.
- Always wear safety equipment when around electrical equipment.

Energy Management

Most humanitarian interventions - and especially the ones performed during emergencies - take place in remote or jeopardised communities with a poor availability and/or limited reliability of the electrical public grid. To operate, humanitarian organisations premises are frequently equipped with at least one independent power supply, either as back up in case of grid failure or as the primary method of producing electricity. Independent power supplies include batteries, generators and solar-electric equipment.

Purchasing, installing and running such equipment requires important investments that can be reduced with proper sizing and energy demand management. Electricity is not cheap, and running a generator can become quite expensive. Energy production also has an environmental impact and has the potential to damage the perception of organisations.

It is often possible to reduce electricity consumption without degrading the quality of service by improving the energy management, focusing on reducing the demand, and choosing the correct supply.

- **Energy Demand Management:** Minimise energy consumption without reducing the quality of service and avoid unnecessary energy consumption.
- **Energy Supply Management:** Select the best main and back-up power supplies in accordance with the situation, properly sized to optimise investment and running costs.

To manage both demand and supply, a proper diagnostic to understand the installation power and energy needs is required. Continued diagnostics will be necessary at each step of the energy management process, mainly:

- To calculate the total energy and power needs of a planned operating environment and help size the power supplies (generator, solar, or other).
- To identify the appliances and services that account for a significant part of the total energy and power needs.
- To understand the variation of the power and energy needs within a day and identify the peak periods.

A complete diagnostic may also be useful in reporting, audits and/or studies purposes.

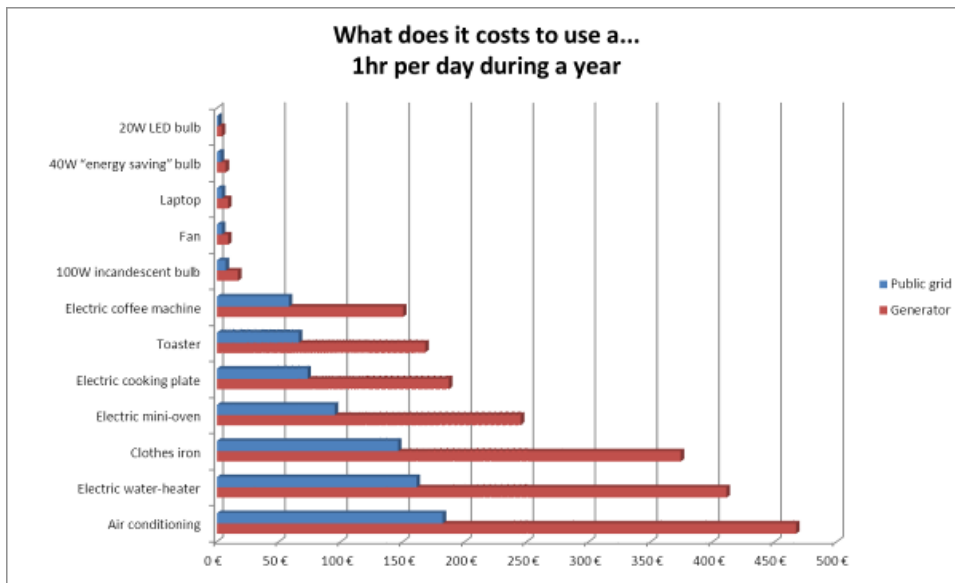

Adapted from, ACF

Energy Demand Management

It is normal to take electricity for granted, however energy always comes at a cost. To improve the way the energy is used, avoid unnecessary consumption and minimise the inevitable without degrading the quality of the service. It is important to think in terms of service instead of devices, and try to find the most effective solutions to accomplish the required service.

Service Requirement: A cool working environment is required, not air conditioning.

Example: Fulfilling the Service Requirement: Consider choosing the room location least likely to heat up, installing white curtains that allow light to enter but reduce the heat, increase the insulation in a room, and then installing an air conditioner.

With the help of the energy diagnostic:

- **Identify high-impact services** to understand what services have significant impact on power and energy consumption and when the peak periods occur.
- **Examine potential alternatives** – working tools, refrigerators, and lighting are obvious consumers of electricity and hard to avoid. Other consumers of energy offer other possibilities, such as water heaters and stoves. Consider possible solutions according to feasibility and initial cost, energy consumption and running cost and service quality.
- **Reduce losses, increase efficiency** by choosing efficient and well-sized appliances according to the purpose and number of users, and by using them in a way that maximises their efficiency, such as cleaning and maintaining equipment and appliances to increase their efficiency.
- **Reduce unnecessary use** by switching off and unplugging appliances when not in use. It may be required to display posters or leaflets to reminder users.
- **Optimise consumption over time**, identifying peak periods and if possible, avoid or postpone the use of the most powerful appliances during peaks or when running on battery/solar back-up systems. Mark powerful appliances who's use can be postponed, such as those for comfort or non-urgent tasks, and differentiate those used for work, security, communications.

Energy Supply Management

Proper selection of main and back-up power supply will have a large impact not only on cost savings, but in the way the energy consumption is optimised. The chosen combination must be able to:

- Deliver enough power for the installation.
- If possible, guarantee a 24/7 availability of electricity in the building.
- Ensure a minimum quality (limited voltage drop or frequency fluctuations).
- Minimise costs.
- Run and operate safely.
- Keep the impact on the local environment as low as possible, including reducing smoke, vibrations, noise during the night, ensure good living and working conditions and prevent neighbourhood conflict.
- Minimise the global environmental impact.

The decision on the type of main power supply will depend mainly if the building is connected to the public electricity grid. Connection to a public grid is considered optimal where available and should be the first option if available. If there is no grid, or the grid is not reliable, then a generator be considered.

A back-up or generator can and will be required if a grid runs the risk of power outages, or when a redundant electrical system is required as an essential safety measure.

There are multiple options for a back-up system, including batteries, solar or smaller generators. There are other things to take into account when selecting a back-up system, including what and how reliable the main source is.



Buying a generator may not be very expensive, but generators require fuel and maintenance and running costs can be quite high. Inversely, battery and solar systems require significant investments but will have very low running costs. Initial and running costs must be considered when choosing a power supply.

Estimated Operating Costs:

Proposed Back-up	Initial Cost	Total Cost After 1 Year	Total Cost After 2 Years
2kVA Generator	600 €	14,600 €	28,800 €
Battery System	4,800 €	9,300 €	13,900 €
Solar (cover ring 30% of energy needs)	6,500 €	9,600 €	12,900 €

Main, Back-up and Possible Combinations

Public Grid + Generator

In many contexts, the main power supply is the electricity provided by the local power company. A back-up is a generator should be able to cover all electricity needs of the installation excluding appliance marked as non-essential. (See energy demand management).

Advantages

Disadvantages

Recommended For

- | | |
|--|--|
| <ul style="list-style-type: none">• Simple and cheap• Locally available• Limited nuisances | <ul style="list-style-type: none">• Short outages occur as the generator must be started when the grid go down• UPS and/or regulator necessary• Fuel supply and stock necessary• Maintenance required for the generator even if it is rarely used |
|--|--|
-

- Building connected to a public grid with long unpredictable outages
 - Building connected to a public electricity grid in a deteriorated security context
 - Building connected to a public electricity grid and used for a limited duration
 - Emergency back up when required
-

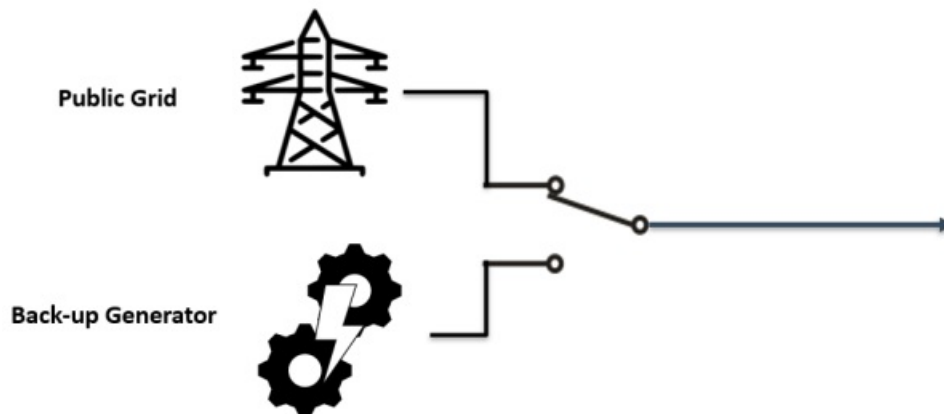

Generator + Generator

In a generator only configuration, electricity is provided by a two or more generators. For using two generators:

- Both generators can either be identical or capable of producing the same amount of power, and can be used interchangeably and following a detailed use plan.
- One generator can be smaller than the other, and be used as a back-up only. In the case of two differently powered generators, the smaller unit it will not need to or be able to cover the entire electricity needs of the operating context, and may need to be wired specifically to power essential items only (see energy demand management).

Advantages

Disadvantages

Recommended For

- | | |
|---|---|
| <ul style="list-style-type: none"> • Locally available • Limited initial costs • Well-known technology | <ul style="list-style-type: none"> • High running cost • Short outage as generators are switched • UPS and/or regulator required • Fuel supply and stock required • Limited reliability and frequent maintenance • Time consuming to manage • Permanent noise and maintenance hassle |
|---|---|
-
- Isolated building with high energy needs
 - Isolated building used for a limited duration
 - Emergency back up when required

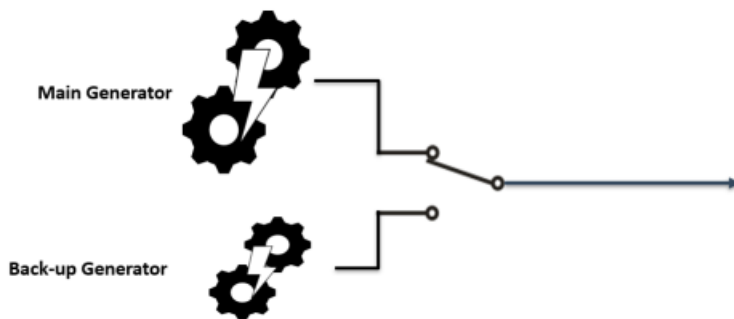

Grid + Batteries

In this configuration, the main power supply is the electricity provided by a local power company, while the back-up is a battery system that provides a limited autonomy to the

installation in case of outage.

Advantages

Disadvantages

Recommended For

- | | |
|---|---|
| <ul style="list-style-type: none">• 24/7 electricity without outage and micro-outage• High reliability• Good electricity quality• Easy to add solar supply• Limited nuisances | <ul style="list-style-type: none">• Grid dependent• Local procurement and maintenance not always possible• Battery room required• Higher initial cost than a generator• Back-up generator may still be necessary• Limited lifespan of the batteries (2 to 5 years) and possible environmental impact of batteries disposal |
|---|---|
-

- Building connected to a public grid with short and frequent outages
 - Building connected to a public grid with night outages
 - First step towards solar system installation
-

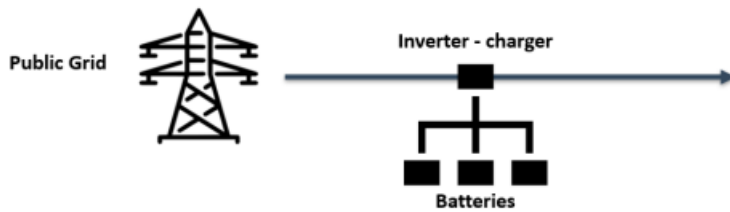

Generator + Batteries

In this configuration the main power supply is a generator that provides electricity during peak hours. The back-up is a battery system that accumulates electricity when the generator is running and supplies the installation during low consumption hours.

Advantages

Disadvantages

Recommended For

- 24/7 electricity without outage or micro-outage
- No nuisance during low consumption hours
- Good electricity quality
- Better reliability and service-life of the generator
- More flexibility on power consumption
- Easy to add solar supply
- Fuel supply and stock required
- Minimum daily running duration for the generator to reload batteries
- Local purchase and maintenance may not be possible
- Battery room required
- Higher initial cost than generator alone
- Back-up generator may still be necessary
- Limited lifespan of the batteries (2 to 5 years) and possible environmental impact of battery disposal

-
- Isolated office or compound
 - First step towards Solar system installation
-

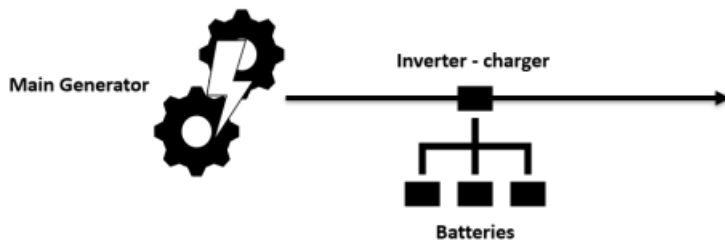

Public Grid OR Generator + Solar

In this configuration, electricity is provided by the main source - grid or generator - during peak hours and by solar system during the day. A battery system accumulates electricity from all sources and supplies the installation when they are off.

Advantages

Disadvantages

Recommended For

Advantages

Disadvantages

Recommended For

- Same as “grid/generator + battery”
 - Lower nuisances
 - Fuel saving, best cost/efficiency ratio on the long run for isolated building
 - Very reliable back-up power supply
- Could require some time to be installed.
 - Local purchase and maintenance may not be possible
 - Battery room and a large open surface required
 - High initial cost
 - Limited lifespan of the batteries (2 to 5 years) and possible environmental impact of battery disposal
-
- Isolated guest-house
 - Isolated building with limited energy needs
 - Isolated building in area where fuel supply is very difficult and/or very expensive
 - Building where security context impose a very reliable and totally autonomous back-up power supply, such as places with possible hibernation requirements.
-

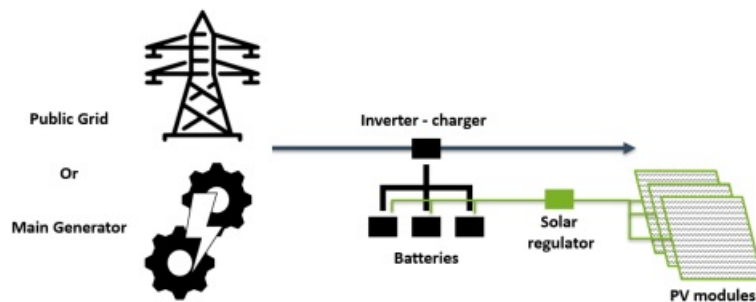

Generators Systems

A generator is a combination of an engine (prime mover) that produces mechanical energy from fuel and an electrical generator (alternator) that converts mechanical energy into electricity. These two parts are mounted together to form a single piece of equipment.

Mechanical generators as a source of power are common in the humanitarian sector apart from the public grid, mainly because they are usually available and can be acquired and installed relatively quickly almost everywhere. Generators are built on a well-known technology and it may not be hard to find a good technician to install one in many contexts. However, operating a generator is expensive, requires frequent and complex maintenance as well as a constant fuel supply. Generators can also cause many problems, such as noise, vibration, pollution, and more.

Generators are useful mainly in three types of situations:

- As a main power supply when there is no public electricity grid available or when the grid has a very poor reliability.
- As a back-up power supply when investing in a more efficient power supply is not possible: emergency, short-term installation, etc.

- As a back-up power supply for buildings with very large energy needs (mainly buildings equipped with air-conditioning or electric heaters).
- As a back-up power supply for installations that holds cold chain capacities.

In any other case, a more complete evaluation should be performed to assess alternatives to the generator. When considering a generator as a main or back-up power, do not underestimate the time required for handling the equipment nor to include in the budget the preparation of its installations.

Characteristics

The following are the main characteristics to consider when selecting the appropriate equipment to cover needs.

Generator Power

The first thing to evaluate when looking for a generator is its size - how much power can it generate?

Example Standard Label on the Side of Generator

Power Generation			
Plot No. B-2, SEZ Industrial area, Nandol, Dist-eastara, India 415523			
Generating Set ISO 8528	G2	SPEC-G	
Model Number	C22D5		
Serial Number	G20148709		
Manufacturing Order Number	A044B085		
Year of Manufacture	7-2020		
Generating Set Max Mass-Wet kg	965		
Controller	PS0600		
Declared Rating	ESP	PRP	COP LTP
Rated Power (KVA)	22.0	20.0	
Rated Power (KW)	17.6	16.0	
Rated Current (A)	31.8	28.9	
Rated Voltage (V)	400	400	
Rated Frequency (Hz)	50	50	
Rated Power Factor	0.8	0.8	
Declared Rating: Enclosed Noise	Standby	Prime	
Average @ 1m dB(A)	-	73	
Average @ 7m dB(A)	-	63	
Average @ 15m dB(A)	-	57	
 LWA 96 dB			
Lwa, 50 Hz @75%Prime as Per 2000/14/EC Directive			

Power rating is standardised as ISO-8528-1. The most common standards are:

ISO Generator Rating	Load Rating	Run Time Limitations
Prime Rated Power (PRP)	Rated for a variable load	This power is available during unlimited hours of usage with variable load factor. An overload of 10% is possible during maximum 1 hour every 12 hours but not exceeding 25 hours per year.
Continuous Operation Power (COP)	Rated for a constant load	This power is available during unlimited hours of usage with a fixed load factor. No overload allowed.
Emergency Stand By Power (ESP)	Rated for a variable load	This power is available only during 25 hours per year with variable load factor. 80% of this power is available during 200 hours per year. No overload allowed.

Load Types

Variable Load

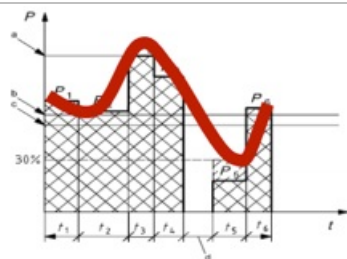

Constant Load

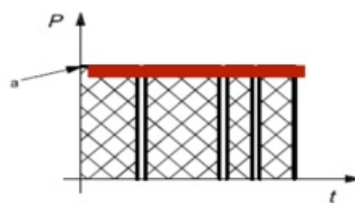

Most of the time, only PRP is relevant when purchasing a generator. When acquiring a generator, check if the power of the generator is indicated without reference to a standardised rating method. If no rating model is indicated, consult with the manufacturer or obtain documentation from the seller.

Power can be rated either in watt (W), kilowatt (kW), volt-amperes (VA) or kilo-volt-amperes (kVA). For the sake of clarity, 1kW = 1000W and 1kVA = 1000VA

A rating in watts indicates a **real power** (P); a rating in volt-amperes indicates an **apparent power** (S). Only real power has to be considered when planning consumption. Real power is the power actually consumed or utilised in an AC Circuit, and therefore it is the way power needs and energy consumption is calculated in a diagnostic exercise.

If only the apparent power (in kVA) is indicated, you can evaluate the real power with the following general formula:

$$P(W) = S(VA) \times 0.8$$

0.8 of apparent power is the assumed real power factor. This may vary from one machine to another, but 0.8 is a reliable average value.

When selecting a generator, it will at the very least need to accommodate the power calculated in the diagnostic exercise. However take into account the following precautions:

Do not confuse kW and kVA: The installation power needs are commonly calculated in kW while the power of the generator is usually rated in kVA. In that case, divide by 0.8 (or add 20%) to convert the power of the installation from kW to kVA.

If the assumed energy needs of an installation are 6,380W, how do we size the generator and what KVA must it be?

The power of the generator must be at least 6.4kW PRP while. To determine the kVA:

Example:

$$6.4 / 0.8 = 8\text{kVA PRP}$$

A power need of 6,380W requires a generator of a minimum of **8kVa**.

Take lower operating rates (derates) into account The power a generator can provide decreases with increases in altitude and temperature. The following chart indicates correlations in environmental factors to derates:

Altitude Derate		Temperature Derate	
□150m	No derate	□30°C	No derate
300m	-1.8%	35°C	-1.8%
500m	-4.1%	40°C	-3.6%
1000m	-9.9%	45°C	-5.4%
2000m	-21.6%	50°C	-7.3%
3000m	-33.3%	55°C	-9.1%

Note that temperature inside the generator room can be far higher than ambient temperature.

A generator has an apparent power of 10kVA, and will operate at 1,000m elevation, and in a generator room with an average temperature of 45°C. What will the anticipated power output be:

Elevation adjustment:

Example: $10\text{kVa} \times (1 - 0.099) = 9.01\text{kVA}$

Average temperature of 45°C:

$9.01\text{kVa} \times (1 - 0.054) = 8.52\text{ kVA}$

The "actual" apparent power is **8.52 kVa**.

Rotation Per Minute (RPM)

Generators' engines usually have either:

- 1,500 RPM: intended for intensive usage (running more than 6 hours) capable to reach high power.
- 3,000 RPM: intended for short term usage, with better power/volume and power/weight ratios but higher hourly consumption of fuel.

1500 RPM generators should be preferred by most humanitarian actors.

Noise Level

An engine is very noisy while running. Noise level is an important consideration while looking for a generator, as it is usually running during working or resting hours. A continuous noise even at very low level can become exhausting over long period of time.

Noise levels are indicated in dB(A) LWA. For comparison purpose here are some common sounds.

Common Source of Sound	dB(A) Level
Refrigerator at 1 m distance	50 dB(A)
Vacuum Cleaner at 5 m distance	60 dB(A)
Main road at 5 m distance	70 dB(A)
High traffic on an expressway at 25 m distance	80 dB(A)
Petrol Lawnmower	90 dB(A)
Jackhammer at 10 m distance	100 dB(A)
Discotheque	110 dB(A)
Threshold of pain	120 dB(A)

An average office should be around 70dB(A), while noise level in a bedroom at night should be lower than 50dB(A).

Note that when comparing noise levels at different distances:

- dB(A) @ 4 meters \square dB(A) LWA - 20.
- Noise level decreases by 6dB each time the distance from the source doubles.

There is a 97 dB(A) LWA generator in a generator room located at 15 meters from a building. What volume will be heard in the building?

97dB(A) LWA is equivalent to 77dB(A) @ 4 meters

77dB @ 4m = 71dB @ 8m

Example:

71dB @ 8m = 65dB @ 16m

The noise level in the building will be approximately **65 dB(A)**, maybe lower depending on the acoustic isolation of the generator room and the office. This is an acceptable level for an office but not for a guest-house at night.

In general, is recommended not to use generators that produce a noise level higher than 97 dB(A) LWA. If the generator will be used at night, it is recommended to use an acoustic canopy,

or build a sound wall to dampen some of the noise pollution.

Tank Capacity

A generator cannot be refuelled while it is running, thus the tank capacity is one of the main factors determining autonomy. A conservative estimation of a 1500 RPM generator hourly consumption is $0.15 \text{ L} \times \text{rated power}$. A fuel tank must be chosen accordingly.

An 8kVA PRP generator powers an office without refuelling it during working day (10 hours). Knowing these numbers, what is the suggested tank size?

The hourly fuel consumption of that generator is:

$$0.15 \times 8 = 1.2 \text{ L / hr}$$

Example:

The calculation for the fuel tank is:

$$1.2 \times 10 = 12 \text{ L}$$

Then the fuel tank capacity must be at least **12L**

It is not recommended to run a tank below 1/5 of its capacity; low tank volumes can draw particles and debris settled on the bottom of the tank into the fuel line, and is potentially dangerous for the engine.

Fuel

Generators – like vehicles - can use either diesel or gasoline, and come with advantages and disadvantages. Diesel generators are more expensive, however diesel is often cheaper than gasoline and diesel generators have better power/volume and power/weight ratios than gasoline generators.

The choice of fuel must be determined according to the local price and availability of both type of fuel. One point to consider is what type of fuel vehicles in the organisations use, using the same fuel for both generators and vehicles can reduce complexities of keeping multiple types of fuel in stock. Safety may also be a concern for very large stock quantities of fuel - diesel fuel also has a significantly higher flash point than gasoline, meaning it will ignite in the open air only above 52°C while gasoline can ignite in below freezing temperatures.

Security

Generators must be equipped with a residual current circuit breaker, so that power surges and short circuits can trip the breaker locally, making it easier to reset and preventing damage from occurring further down the circuit. Additionally, generators usually have a manual breaker/transfer switch to control the connection of electricity to the installed circuit of the office or compound.

Generators should also have an emergency stop button, in case of fire, catastrophic mechanical failures, or other issues. An emergency stop button should be clearly marked. Generators with acoustic canopy should be equipped with an emergency stop push button outside the canopy.

Generator Set Up

Generator Room/Storage Area

Generators generally require a specific place to be domiciled. Unless a generator is specifically designed for mobile applications, generally they do not usually move. A generator's location has an impact on its functioning and lifespan, and needs to be well planned.

Some generators can be extremely heavy and bulky, and often their location around an office or compound will depend on the ability for mechanical equipment or vehicles to load/offload the full-sized generator.

Generators should be installed on a flat, even surface. Unlike vehicles, generators are not designed to operate on slants or while tilted. A slight slant or grade may cause generators to move slightly over time with vibration or exposure to the elements, which can damage structures and equipment, or make servicing equipment difficult. If a heavy generator moves in an enclosed space with a built-up structure around it, moving by hand may be impossible.

The foundation of wherever a generator is housed should be sufficient to support the generator weight and be electrically neutral. Generators can be extremely heavy, and over time can break down or degrade poor foundations, or even shift in their orientation. Additionally, the vibrations of a running generator can greatly speed up degradation of the foundation or storage area, especially if the generator is not securely fashioned in place – the vibration works like weak but constant jack-hammer.

It is good practice to install some kind of shock absorber to reduce generator vibrations, such as timber or rubber pieces. This helps reduce vibration by slightly raising the equipment, and also help control heat while making the unit easier to inspect and identify leaks.

Depending on the layout of the required operating space, generators may be installed in stand-alone rooms, be housed in some sort of open-sided generator shed, or may be exposed to air. Ideally, generators will have at least a roof or other form of covering above them to protect from rain, snow or excessive direct sunlight, all of which can impact the operation of a generator. Due the size and weight of generators, the shed or room may have to be built after the generator has been delivered, offloaded, and installed.

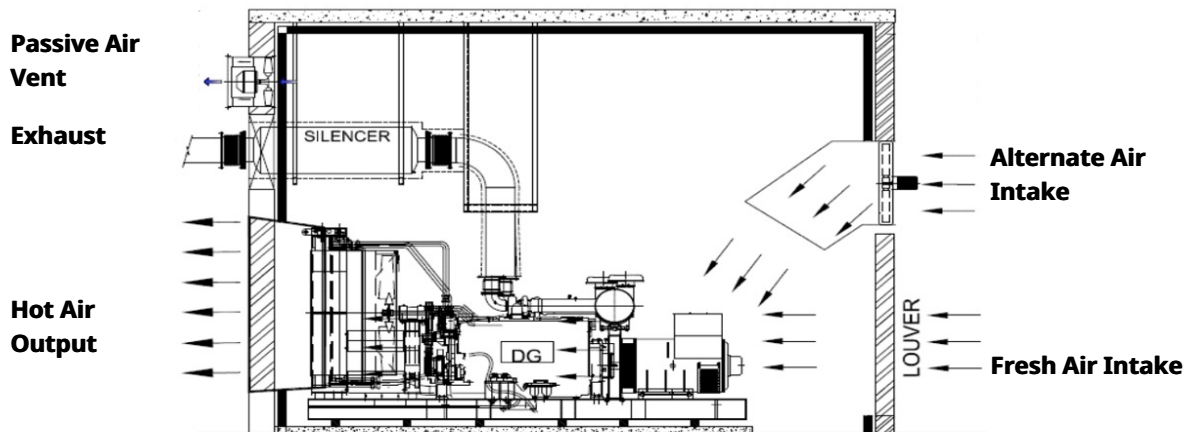

The room or storage area must cover several purposes; isolate the generator to decrease the noise and environmental impact on its surroundings, and preventing non-authorized access from staff, visitors, animals, or others. Even if a generator is relatively exposed, such as a covered awning with no walls, it is still advisable to have some sort of access control to the physical generator. The generator's storage areas may require additional physical built up walls on one or more side of the generator to block noise and prevailing winds.

Although construction materials can vary, the orientation must be planned carefully, taking advantage of the wind currents and minimizing the noise and heat disturbances. A generator space should always be well ventilated, including the use of soffit vents or entirely exposed walls. If a generator is in a tightly enclosed space, specially made air outlet ducts are required. Ensure all outlets don't discharge into areas where humans and animals work or access frequently. If no other option is available than to ventilate into areas where humans and animals access, then all discharge points should be at least two meters from said spaces and be well marked.

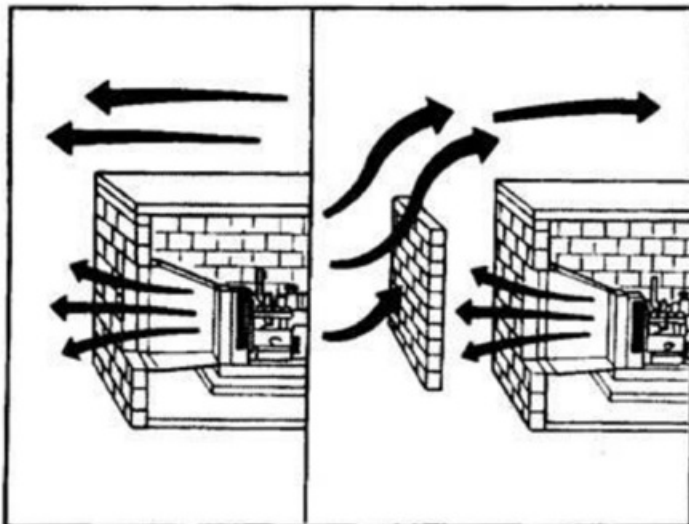

Wherever possible, position fuel or other dangerous goods so that the prevailing wind do not enter into the radiator/exhaust outlet. If this is not possible, install a wind barrier.

Running a Generator

While there are general rules and best practices when running a generator, the best source of

information is always the user manual for the accompanying machine, which provides full details about its usage and maintenance. Guidance coming from the manufacturer must always be followed.

In general, proper management of a generator starts by having an accurate and up to date monitoring system. Monitoring is crucial for performing analysis, identify potential failures and misuses, and informing future repairs and decision making. It is important to maintain records at least on:

- Running hours.
- Refuelling.
- Maintenance performed.

A simple but complete logbook should be used. A logbook should be kept near the generator, and all persons managing the generator should be trained and sensitised in its correct use.

Even though PRP generator types are rated for “unlimited” usage, this does not mean generators can run for an unlimited continuous time. Generators are still machines, which suffer from degradation and can overheat or break down. The continuous operation of generators may vary from machine to machine, but generally speaking the generators that humanitarian agencies obtain in field contexts are not designed to operate for more than 8 to 12 hours of continuous use at one single time. Running a generator for longer than an 8 to 12 hour period can dramatically shorten the life of a generator and lead to a higher frequency of break downs.

Generators usually must be switched off for a cool down period, which is why many agencies will install two primary generators in a compound or office. The two generators are generally installed near each other if not in the same storage room, and are both connected to the main electrical circuit of the facility. If two generators are installed in tandem, there should be a large external transfer switch to route power coming from either one or the other generator at one time. A no point should both generators be able to supply an electrical current to the same closed circuit at the same time – this could cause catastrophic damage to facilities and equipment.

The use of two generators can be planned according to needs – either both generators should have identical power supplying capability, or the secondary generator is used for hours when load requirements are less. Solar power and other backup power supplies can also be connected to the external transfer switch. Usually, the act of switching between generators includes starting the incoming generator while the outgoing is still running. This will allow the incoming generator to warm up. It will also allow the main transfer switch to move between generators while power is being supplied, to minimise disruption to offices or living quarters.

Starting and Stopping a Generator

Generators above a certain size and made for medium to long term usage generally have an internal switch used to connect or disconnect the unit from the main installed circuit of the office or compound. If the generator switch is set so that the generator is not connected, the motor will still run and the alternator will still produce electricity, however the main circuit will not be able to receive an electrical current.

Generators must never be started or stopped while connected to the installation, also called “loaded”

When a generator turns on, there may be spikes or stalls to the power produced, due to air in

the fuel lines, debris or other normal parts of the start-up process. These surges in power can exceed the load rating of any given installation and can damage equipment if not properly protected. It is a good practice to have a poster or leaflet in the language of the persons operating the generator explaining the process to start and stop the equipment that includes photos of the main parts to touch and the actions to be taken.

Standard starting procedure:

1. Make sure that the generator circuit breaker is open (if the generator does not have a circuit breaker: make sure that the installation main breaker is open).
2. Check the oil level.
3. Check the fuel level.
4. Check the water level (for water-cooled generators only).
5. Make sure that there is no leakage (no oil or fuel under the generator).
6. Start the generator.
7. Wait 2 minutes.
8. Close the circuit to the main circuit of the office or compound.
9. Record time of start on the associated logbook.

Standard stopping procedure:

1. Warn users that the power will be cut.
2. Open the generator circuit breaker (if the generator does not have a circuit breaker: open the installation main breaker).
3. Wait 2 minutes and.
4. Stop the generator.
5. Record time of stoppage on the associated logbook.
6. Refuel if necessary.

Care & Maintenance

A generator must be regularly maintained to ensure it provides quality power throughout its life. Routine maintenance is relatively straight forward - there are general guidelines on what and when services are needed to prevent failures or enhance the equipment functioning.



While generator maintenance best practice is following the manufacturer's maintenance and schedule, the following controls and operations can be applied as a close approximation, especially if the manufacturer guidelines are unknown.

MAINTENANCE OPERATION	MAINTENANCE FREQUENCY				
	Daily or every 8 hours	Every Month	Every 150 hours	Every 250 hours	Every 500 hours
General Inspection					

MAINTENANCE FREQUENCY

MAINTENANCE OPERATION	Daily or every 8 hours	Every Month	Every 150 hours	Every 250 hours	Every 500 hours
Check Engine Oil & Fuel Level					
Clean and Check Battery					
Check Grounding connection					
Clean Spark Arrester					
Clean Fuel Filters					
Drain fuel Tank					
Change Engine Oil					
Replace Air & Fuel Filter Element					
Clean Engine Cooling Fins					
Replace Spark Plug(s)					

MAINTENANCE FREQUENCY

MAINTENANCE OPERATION	Daily or every 8 hours	Every Month	Every 150 hours	Every 250 hours	Every 500 hours
Check fuel injection nozzle					
Replace Fuel Filter					
Adjust Valve Lash					

Service hours are tracked in “running hours,” meaning only the hours while the generator is actually on and supplying power. Note that even if running a generator for an average of 12 hours, reaching 250 or 500 hours of total running time can occur extremely quickly, meaning the service intervals for generators can be quite frequent. Small investments made in replacing components and maintaining generators on a regular basis can save expensive and unnecessary upgrades or even replacement of the entire unit in the future.

When performing routine maintenance, each action taken should be logged, as well as the readings and parameters recorded along with the date of inspection and the hour meter reading. These sets of readings are compared with the next set of data collected. Any considerable variation of reading may indicate faulty performance of the unit.

Preventative maintenance thus ensures that the organisation has an uninterrupted power supply for all their needs. If a generator is rarely used, it is essential to start it at least once a week to keep it in good condition.

	Intensive Usage	Occasional Usage
Starting generator	As often as required	At least once a week
150 hours maintenance	Every month	Every 4 months
250 hours maintenance	Every 3 month	Every year
500 hours maintenance	Every 6 months	Every 2 years

Corrective Maintenance

In some programs or sites of operation, it makes sense to have a trained repair technician permanently as part of the team. In most cases, it is recommended to identify and establish a long-term agreement or other form of service contract with a trusted provider. Service providers should be in charge of the main maintenance and be ready in case of breakdowns. Important criteria when selecting a third-party provider is their ability to supply spare parts for the required equipment. If a third-party provider cannot supply spare parts, then organisations will need to maintain a stock of their own spare parts.

A generator set is the combination of an engine and an alternator plus wiring, controls, protections and connections. These are the components that need to be checked when looking for a failure.

There are four types of possible generator malfunctions:

- The engine does not start.
- The engine starts, but it stalls or misses.
- The engine works but starts overheating after a while.
- The engine runs smoothly, but the electricity is not properly generated.

It is recommended to refer to the user manual for specific fault-finding instructions as designs vary between manufacturers. Unless a problem is immediately identifiable, a professional generator technician or a qualified electrician may be required.

Safety Considerations

- A generator must never be operated in a room continually occupied by persons or animals.
- A generator room must be correctly ventilated.
- Fuel and oil must not be stored in the generator room.
- A fire extinguisher rated for electric and fuel fires (preferably a CO2 fire extinguisher) must be available outside the generator room. Fire sand bucket can be an option when extinguishers are not available or as a backup.
- All generator must be properly grounded. Usually, generators come with a grounding bolt in the frame marked with the ground symbol, to which ground cables should be attached.

If there is no evident bolt, the ground line can directly be connected to the metallic frame of the generator.

Battery System

A battery system leverages chemical reactions to store electricity for later use, be it electricity from a generator or public. In technical terms the electricity itself cannot actually be stored, but the relative energy equivalent is stored as potential energy through chemical reaction, and can be transformed into electricity later. Chemical batteries work by charging a solution that retains the charge long enough to be discharged again and distributed later.

System Architecture

Batteries are finite storage mediums and operate in relatively simple ways.

Batteries can only receive and supply DC currents, while most large electrical appliances and power sources use AC currents. To accommodate this, batteries require external devices to convert currents based on usage and need.

- To receive an AC current the battery will need a transformer or specialised battery charger.
- To deliver an AC current, the battery will need an external inverter.

These 2 devices are often combined into an inverter-charger which can be used as an intermediary between the battery and the closed circuit.

As each battery has a limited capacity, battery power supplies require special equipment to monitor and control the flow of electricity entering a battery, called a charge controller. A charge controller will continuously monitor the charge state of a battery – recognising how “full” it is – and should automatically terminate charging once a battery is full. Batteries are highly energetic and can be extremely dangerous if over charged! An overcharged battery can spark, start fires, and even explode, possibly throwing hazardous chemicals while it does. No battery power backup should be attempted without a proper charge controller in place.

Just like a generator installation, a battery power backup should also have all available protections in place, including breakers, fuses, and a grounding cable.

Thus, a battery system usually includes:

- One or more batteries.
- Inverter-charger.
- Charge controller.
- Cabling and protective devices such as fuses and grounding.

Batteries

A battery is a storage device capable of storing chemical energy and converting it into electrical energy through electrochemical reaction. There are many different types of chemistry that are used, such as nickel-cadmium batteries used to power small portable devices or Lithium-ion (Li-on) batteries used for larger portable devices. The most proven type of chemistry and the longest used however is the lead acid battery.

Types

Batteries are made with several materials and shapes suitable for different purposes. This guide will focus on the most common batteries used as a back-up for power generation sources. The two main types can be summarised as:

1. Flooded Batteries.
2. Valve Regulated Lead Acid Batteries.

Flooded Batteries:

Flooded cell batteries are the most common conventional battery used in internal combustion vehicles. Flooded cell batteries are referred to in several ways:

- Flooded Battery.
- Wet Cell Battery.
- Spillable Lead Acid Battery.
- Resealable Lead Acid Battery.

These batteries contain a combination of a liquid electrolyte that is free to move in the cell compartment. Users have access to the individual cells and can add distilled water (or acid) as the battery dries out. The main characteristic of this kind of battery is their low cost, which makes them available almost everywhere in the world and widely used in low income or developing economies. Handling flooded batteries are quite easy, and they can be charged with a simple unregulated charger. However, these batteries require periodic inspection and maintenance, and extreme climates can have a greater effect on battery lives due to the electrolyte solution inside the battery having the ability to evaporate or freeze.

These batteries are commonly made with two terminals and 6 caps allowing access to each 2V compartment or cell, giving 12V in total. For this type of battery, the typical absorption voltage range is 14.4 to 14.9 volts and a typical float voltage range 13.1 to 13.4 volts.

Car or truck batteries are not suitable to be the permanent system for storage Vehicle batteries are designed to provide high current during short periods, specifically to start a combustion engine. There are lead-acid batteries that are specifically designed recently for storage applications.

VRLA (Valve Regulated Lead Acid) Batteries:

Valve Regulated Lead Acid (VRLA) battery is a term that can refer to a number of different makes and designs, but all share the same property - they are sealed. VRLA batteries are sometimes referred to as sealed or non-spillable lead acid batteries. The sealed nature of the batteries make transport easier and less dangerous, and may even be transported via aircraft under certain circumstances. Being sealed however reduces their lifespan as they cannot be refilled – on average their life span is 5-years at 20°C.

VRLA batteries are usually more expensive and require a fully regulated charger, which makes them less common throughout the world. These batteries may still use lead acid as a chemical solution, but they may use threaded pins instead of chambers and terminals.

The namesake of the battery comes from a valve regulating mechanism that allows a safe escape of hydrogen and oxygen gasses during charging. There are also more advanced designs, including:

**Absorbed
Glass Mat
(AGM)
Batteries**

The AGM construction allows the electrolyte to be suspended in close proximity with the plate's active material. This enhances both the discharge and recharge efficiency.

Since there is no liquid inside, these batteries can perform better than flooded batteries in applications where maintenance is difficult to perform, however they are sensitive to over or under charging affecting their life and performance. AGM batteries perform most reliably when their use is limited to the discharge of no more than 50% of battery capacity.

AGM batteries are usually the type of batteries selected in off-grid power systems.

**Gel Cell
Batteries**

Gel cell batteries have a water-acid in gel form. The electrolyte in a gel cell battery has a silica additive that causes it to set up or stiffen. The recharge voltages on this type of cell are lower than the other styles of lead acid batteries, and gel cells are probably the most sensitive cell in terms of adverse reactions to over-voltage charging.

Gel batteries are best used in very-deep cycle applications and may last a bit longer in hot weather. Unfortunately a total deep discharge will irreversibly destroy the battery. If the incorrect battery charger is used on a gel cell battery, poor performance and premature failure is certain.

Note: It is very common for individuals to use the term gel cell when referring to sealed, maintenance-free batteries, much like one would use a brand name when referring to an entire product category. Be very careful when specifying a charger - more often than not, when someone is referring to a gel cell they really mean sealed, maintenance-free VRLA or AGM-style battery. Gel cell batteries are not as common as AGM batteries, and would be hard to source in humanitarian contexts.

Battery Type	Absorption Voltage Range	Float Voltage Range
Flooded Batteries	14.4 to 14.9 volts	13.1 to 13.4 volts.
VRLA Batteries	14.2 to 14.5 volts	13.2 to 13.5 volts.
AGM Batteries	14.4 to 15.0 volts	13.2 to 13.8 volts.
GEL Batteries	14.0 to 14.2 volts	13.1 to 13.3 volts.

Capacity

Capacity is defined as the total amount of energy a battery can store and reproduce in the form of electricity. Battery capacity is usually described in multiples and orders of magnitude of Watt-hours (Wh) – 1 Wh to one 1 kWh (1,000 Watt-hours). A Watt-hour is defined as the electrical energy required to supply a Watt of electricity for one continuous hour. For example, a standard 60W incandescent bulb would require 60Wh of stored energy to function for one

hour. It is easy to see why properly estimating consumption needs are important for designing battery back-up systems, especially for security or mission critical related items.

Probably the most important specification of a battery is its capacity rated in Amp-hours (Ah). Determining Wh is done when Ah are combined with battery voltage - often 12 volts.

Energy (Wh) = voltage (V) × capacity (Ah)

A battery capacity depends on:

- **Discharge Duration:** Usually manufacturer indicated capacity at 20hrs, noted as C20. For a C20 batter, the same battery will be able to deliver more energy in 20 hours than in 10.
- **Temperature:** Capacity can increase or decrease with external temperature. Rating is benchmarked at 20°C.

Also keep in mind that cycling a battery through its full capacity will likely damage it if done repeatedly. To increase battery lifespan, there should always be some energy left in it before recharging. For this reason, usually only 50% of the capacity is used. As a result, the energy a battery can actually deliver is better measured by looking at half its full capacity.

Energy = 0.5 × voltage × capacity

A 100Ah battery contains 1,200Wh:

$$100 \times 12 = 1,200\text{Wh}$$

Example: To increase its lifespan only 600Wh can be used. How long would a 40W light bulb last in continuous use?:

$$600\text{Wh} / 40\text{W} = 15 \text{ hours}$$

A 40W light bulb could run for **15 hours** before the battery needed to be recharged.

As a rule of thumb, the larger the battery and the higher the capacity, the more efficiency increases while the price per watt-hour decreases. It is recommended to use the battery type with the highest capacity available, and then work off multiples of that battery type to reach the overall energy storage needs. Continually adding smaller, lower capacity batteries will lead to higher costs and more problems later on.

Float Life

Float life is the expected service life of a battery if undergoes continuous charge, and is never discharged. When a battery is installed in an electrical system that constantly receive a charge, it is called "float charging." If power is cut and float charged batteries are switched to, the "float life" indicates how long these batteries can last. Float life decreases with temperature and manufacturer float life is usually rated at 20°C. As a general rule, float life will reduce by approximately half for every average temperature increase of 10°C.

A battery with a rated float life of 10 years at 20°C. How long will it last if the average temperature is 30°C?

Example: $10 / 2 = 5$ Years

It will last **5 years** if the average temperature of the battery room is 30°C and only **2.5 years** if the average temperature of the battery room reaches 40°C.

Cycle Life

In addition to float life, "cycle life" is the number of cycles that the battery can withstand during its service life. A battery cycle is defined as a battery being fully charged and then fully discharge, making one full "cycle." It is common to have this information in technical specifications, and it is recommended to buy batteries with a cycle life of more than 400 cycles.

Cycle life depends on the depth of discharge. A 50% depth of discharge is a good compromise between over-investment and quicker degradation.

Other Specifications

The other characteristics of a battery are:

- **Self-Discharge Rate:** Self-discharge rate is defined as how quickly a battery will dissipate electricity if stored full but unused. Useful only if the batteries are intended to be stored for long duration. A lead-acid battery self-discharge rate is generally below 5% a month.
- **Freezing Point:** A battery will be destroyed if its electrolyte solution freezes. The freezing temperature depends on its construction, composition, and rate of charge, and a discharged battery freezes more easily. A battery freezing point is almost always below that of water, however.

Number of Batteries Needed

The type of battery required for an installation will depend on the power needs, the budget, in the country of operations, and the conditions under which they system has to perform.

Once the battery model has been identified, the number of batteries required must be calculated. This can be done with the following formula, always rounding the number up.

Number of batteries = (Energy consumption) / (max cycle depth × Battery voltage × Battery capacity)

A system analysis indicates a need for 12,880Wh. The available batteries are 220Ah / 12V, and require a 50% maximum depth of discharge. How many batteries are required?

Example:

$$12880 / (50\% \times 12 \times 220) = 9.76$$

10 batteries are required.

Note that all the batteries used in a battery system must be exactly the same:

- **Same Capacity:** if 500Ah are needed it is not possible to use 2 x 200Ah + 1 x 100Ah. The system would require 5 x 100Ah or (preferably) 3 x 200Ah.
- **Brand and Model:** As much as possible, batteries should be the same brand and model.
- **Age:** As far as possible, all batteries should have the same "history". It is strongly recommended to not mix old and new batteries, even if they are the same model.

Inverter-Charger

While it is important to select batteries that have the correct storage capacity and design, inverter-charger devices can increase the efficiency of the system. Equally, an inverter-charger can damage a system if it is installed incorrectly, or if it is malfunctioning or poorly designed. The purpose of an inverter-charger is to transform current from AC to DC to charge batteries, and from DC to AC to discharge batteries. Inverter-chargers can do much more however – they can function as the "brain" of the electrical installation, coordinating the energy flows between the main source (generator or grid), batteries, and the end user. A proper inverter-charger can provide a far better quality of service than any other back-up systems, including:

- Power available from the inverter can be as high as 4 times the maximum power of the main power supply.
- Increased generator lifespan.
- Regulated voltage and frequency.
- Uninterrupted power supply.

Inverter-chargers should be purchased along with:

- Battery controllers.
- Temperature sensors.

Battery Cable Connections

The cables that join batteries together play an important part in the performance of the battery system. Choosing the correct size (diameter) and length of cable is important for overall system efficiency. Cables that are too small or unnecessarily long will result in power loss and increased resistance. When connecting batteries, the cables between each battery should be of equal length to ensure the same amount of cable resistance, allowing all batteries in the system working equally together.

Particular attention should also be paid to where the main system cables that are connected to the battery bank. All too often the system cables supplying the loads are connected to the first or "easiest" battery to get to, resulting in poor performance and service life reduction. These main system cables that run to the DC distribution (loads) should be connected across the

whole battery bank. This ensures the whole battery bank is charged and discharged equally, providing optimal performance. The main system cables and the cables joining the batteries together should be of sufficient size (diameter) to handle the total system current. If there is a large battery charger or inverter it is important to be sure that the cables are capable of carrying the potentially large currents that are generated or consumed by the connected equipment, as well as all the other loads.

Installing a Battery System

Battery Room

A battery room has the same purpose as a generator room:

- Isolate the battery system to decrease the risk of accident - such as acid leakage or harmful gas emissions - and prevent non-authorized access.
- Ensure good operating conditions: a battery room must protect electronics against water and dust, and be well ventilated.

Batteries used for power back up and distribution need a specific place to be located, and must be well planned. It is convenient to have the battery room close to the main power supply or the distribution board, however the batteries must not be installed in the same room as the generator. High or fluctuating temperatures considerably affect the service life and batteries performance, and it is recommended to have a separate well ventilated battery room with a temperature as close as possible to 20°C. A dry and ventilated cellar or underground room is a perfect location, provided the underground storage location will not flood or collapse.

Under no circumstances should battery storage locations be located in living or working spaces. A fully charged battery is highly energetic, and can spark, give off fumes, combust, or even explode. A faulty charger or an overcharged battery may display signs of distress, including swelling and smoking. However, an overcharged battery may also display no signs and provide no warning. A ruptured battery can propel shrapnel and throw very toxic chemicals, while the fumes may be extremely harmful or even lethal if breathed. If a battery shows any signs of warping, distress or overheating, the entire system should be shut off, and the battery should be disconnected when safe to do so. Do not attempt to reuse damaged batteries – they should be disposed of safely, and in accordance with local laws and regulations.

Installation Sizing

To size a battery system, the following will need to be determined:

- The maximum power the inverter has to be able to deliver to the installation.
- The amount of energy that must be stored in the battery to cover your needs.
- In some case, the power the charger can deliver to the batteries.

Please reference the section on [energy management](#) on how to calculate the power and energy the system has to deliver.

To manually calculate the maximum power of the installation:

1. List all electric appliances fed by the installation.
2. Find the maximum power of each electrical appliance. For appliances including an electrical motor the maximum power is approximately three times the nominal power. For example, a 300W water pump will need around 1kW to start.

3. Add all power together.

To manually calculate the energy consumption of the installation:

1. List all electric appliances fed by the installation and their nominal average power.
2. For each appliance determine how long should be in use. The assumed energy needed for each appliance can be calculated by: average power x duration.
3. Add all energy requirements together.

Take into consideration the hours that the battery system is intended to deliver electricity and plan accordingly. A battery configuration won't be the same if the system will deliver power only during night or be used as a full day twenty-four-hour backup. If it is possible, plan to run a generator during peak energy consumption hours, decreasing the number of batteries required and reducing the full cost of the system.

The power of the battery charger will determine how long recharging will take. A high-power charger that can charge batteries rapidly is useful if the main power supply is very expensive – a big generator with high consumption - or if the electricity from the main power supply is only available during short duration - public grid available only few hours per day.

To be able to charge the batteries in a fixed duration, the formula to use is:

Power=Energy consumption / charge duration

An installation has an estimated energy consumption of 12,880Wh, and needs to reach a full charge in 6 hours. What Wattage must the charger be?:

Example: $12,880 / 6 = 2,150W$

The charge power must be at least **2,150W**.

Charger power is often rated in current (Amps) rather than in power (W). To calculate charge current from the charge power simply divide the charge power by the charger voltage (usually 12, 24 or 48V).

- If 12V charger is used, the charge current must be: $2,150 / 12 = 180A$.
- If 48V charger is used, the charge current must be: $2,150 / 48 = 45A$.

Additional considerations:

- The minimum duration to charge battery is 4 hours. Faster charging may damage batteries, and some batteries may have limitations longer than 4 hours.
- Even with a powerful battery charger, the charge may be longer due to the limited power available from the main power supply - with 5kW generator, buying a 10kW charger is pointless.
- For chargers that have advanced settings, the charge algorithm may extend charge duration to save battery life. Some chargers automatically decreases the charge power when the battery is close to 100%.

Connecting Batteries

There are several ways to wire multiple batteries to achieve the correct battery voltage or capacity for a particular DC installation. Wiring multiple batteries together as one big bank, rather than having individual banks makes them more efficient and ensures maximum service life.

Series Connection



Wiring batteries together in series will increase the voltage while keeping the amp hour capacity the same. In this configuration, batteries are coupled in series to gain higher voltage, for instance 24 or even 48 Volt. The positive pole of each battery is connected to the negative pole of the following one, with the negative pole of the first battery and the positive pole of the last battery connected to the system.

For example; 2 x 6V 150Ah batteries wired in series will give 12V, but only 150Ah capacity. 2 x 12V 150Ah batteries wired in series will give 24V, but still only 150Ah.

Parallel Connection



Wiring batteries together in parallel has the effect of doubling capacity while keeping the voltage the same. Parallel coupling involves connecting the positive poles and negative poles of multiple batteries to each other. The positive of the first battery and the negative of the last battery are then connected to the system.

For example; 2 x 12V 150Ah batteries wired in parallel will give only 12V, but increases capacity to 300Ah.

Series/Parallel Connection



A series/parallel connection combines the above methods and is used for 2V, 6V or 12V batteries to achieve both a higher system voltage and capacity. A parallel connection is required if increased capacity is needed. The battery should then be cross-wired to the system using the positive pole of the first and the negative pole of the last battery.

For example; 4 x 6V 150Ah batteries wired in series/parallel will give 12V at 300Ah. 4 x 12V 150Ah batteries can be wired in series /parallel to give you 24V with 300Ah capacity.

Solar Systems

Sunlight and the Photovoltaic Effect

The photovoltaic effect is the process of using sunlight to produce DC electricity in a silent, clean, and autonomous way. The equipment required to produce this electricity is commonly called a "solar panel," and are modular and require minimum maintenance. Combined with their long durability solar systems are increasing in popularity in remote areas or when an installation is expected to last.

Solar panels are devices able to transform light radiation into electricity through a process of trapping the photons and using them to excite P-type and N-Type semiconductors to move free electrons. Modern photovoltaic panels can generally convert around 15-20% of energy directly into electricity. There are panels that are more efficient, but they are very costly, easy to damage, and are generally not accessible in places where humanitarian organisations might work.

Light enters the device through an anti-reflective coating that minimises the loss of light by reflection. The device then effectively traps the light striking the solar cell by promoting its transmission to the three energy-conversion layers below.

- N-Type Silicon layer; Provides extra electrons (negative).
- P-N junction layer. The absorption layer, which constitutes the core of the device orienting the electrons in one direction.
- P-Type Silicon layer; Creates vacancy of electrons (positive).

Two additional electrical contact layers are needed to carry the electric current out to an external load and back into the cell, thus completing an electric circuit.

Most solar cells are a few square centimetres in area and are protected from the environment by a thin coating of glass or transparent plastic. Because a typical 10cm×10cm (4 inch × 4 inch) solar cell generates only about two Watts of electrical power, cells are usually combined in series to boost the voltage or in parallel to increase the current. A solar, or photovoltaic (PV), module generally consists of 36 or more interconnected cells laminated to glass within an aluminium frame.

One or more of these PV modules may be wired and framed together to form a solar panel, and multiple panels can be combined to form a solar array, together supplying power as a single unit.

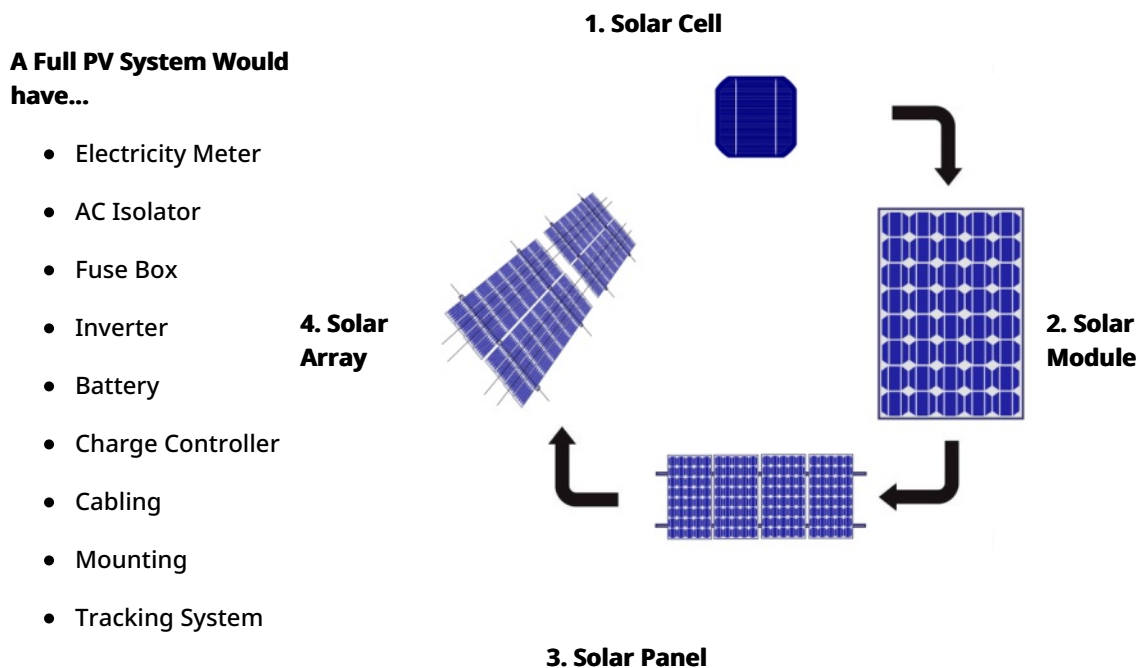

Solar Cell Degradation

All solar cells - and by extension solar panels - degrade over time. While solar systems draw energy from the sun, the sun also slowly breaks down the components of solar cells. Most commercially available solar panels degrade at an average rate of 2% per year of usage. The duration of use of an installation must be factored for planning and budgeting purposes. For example, a solar array installed in direct sunlight degrading at 2% a year means that after 10 years, the panels will only be roughly 80% as efficient as they were at the time of installation. Less efficiency means less Wattage output from the array, meaning longer periods of of time

to charge batteries and less optimal charging times throughout the day. Humanitarian agencies planning to use solar arrays longer than 10 years in a single location may want to consider budgeting for the replacement of panels after 12-15 years if the overall output is no longer meeting the needs of the location.

System Architecture

A complete photovoltaic system may consist of one solar module or many, depending on the power needed. While batteries can be used as back-up of any main power supply, solar systems need a battery system to store the energy produced. Therefore, a solar system always includes some form of battery system, either small or big. These batteries are specifically designed to deliver limited current over long period of time.

A power system can accommodate different electrical loads by regulating the voltage and/or current coming from the solar panels going to the battery to prevent overcharging. Most "12 volt" panels can put out about 16 to 20 volts in optimal conditions, so if there is no regulation the batteries can and will be damaged from overcharging. Most batteries need around 14 to 14.5 volts to become fully charged. Like any other electrical system, proper assessment and cabling are required.

A solar system is usually composed by:

- PV module, solar panel or array, including its multiple types of mounts.
- A battery system.
- A solar regulator.
- Cabling and protections.

Solar systems can accommodate almost any specific need because they are modular in nature. This makes it possible connect PV modules directly do many devices, such as submersible pumps or standalone freezer units, or as a complete solar power arrays able to produce energy for entire offices or compounds.

Solar Modules

Solar modules are rated in Watt-peak, represented as nominal peak power (P_{max}), derived from multiplying peak power voltage (V_{mp}) with its peak power current (I_{mp}):

$$P_{max} = V_{mp} \times I_{mp}$$

A 100Wp solar panel produces 100W under standard test conditions (STC). The STC exist only in laboratories, applying a solar irradiance to panels of 1,000W/m² with a cell temperature of 25°C. In a real installation, the actual production of electricity is usually far lower than the peak-power, however the measures remain useful as qualitative reference to compare sizes and capacities as every panel is rated under the same conditions.

Example Label that Comes with Solar Panel

RENOXY

Module Type: RNG-100MB

Max Power at STC (P_{max})	100 W
Open-Circuit Voltage (V_{oc})	21.2 V
Short-Circuit Current (I_{sc})	6.10 A
Optimum Operating Voltage (V_{mp})	17.7 V
Optimum Operating Current (I_{mp})	5.70 A
Temp Coefficient of P_{max}	-0.38%/°C
Temp Coefficient of V_{oc}	-0.28%/°C
Temp Coefficient of I_{sc}	0.06%/°C
Max System Voltage	600VDC (UL)
Max Series Fuse Rating	10 A
Fire Rating	Class C
Weight	6.8kg / 15lbs
Dimensions	1038x533x35mm / 40.9x21.0x1.37in
STC	Irradiance 1000 W/m ² , T = 25°C, AM=1.5

WARNING-ELECTRICAL HAZARD
This module produces electricity when exposed to light.
Follow all applicable electrical safety precautions.

ATTENTION-RISQUE ELECTRIQUE
Ce module produit de l'électricité lorsqu'il est exposé à la lumière.
Suivre toutes les précautions électriques de sécurité applicables.

CE, ISO 9001, ISO 14001, IEC 61730, and other certification logos.

The amount of electrical energy produced during a single by a solar module depends mainly on:

Daily Irradiance: The quantity of energy provided by the sun in one day is the most important parameter. Areas close to the equator have the best average irradiance, however this general rule may vary greatly from one place to the other and from one season to the other. The average performance of a PV system expressed in kWh/m²/day can be referenced in the chart below.

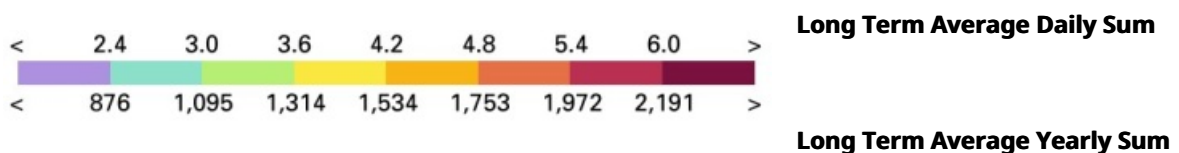

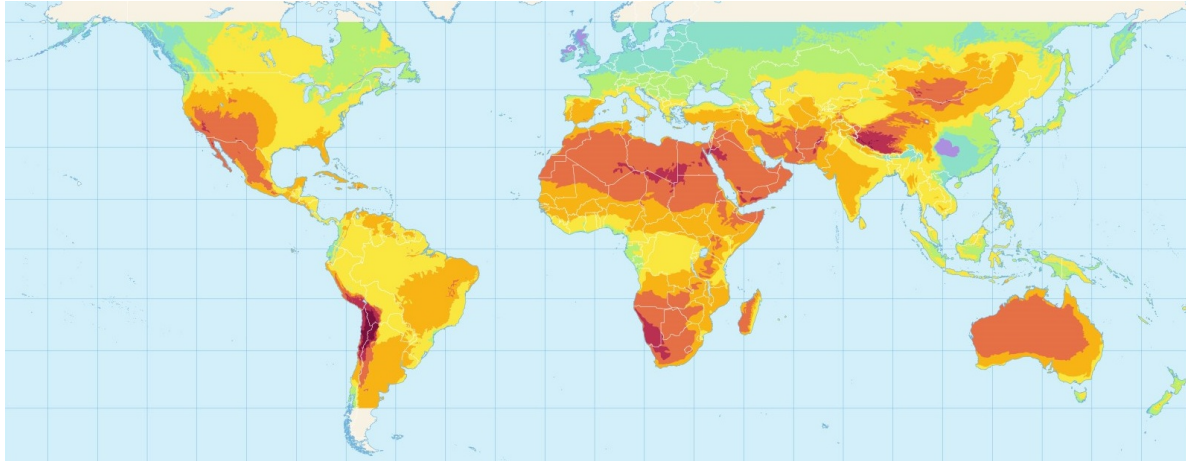

Shade, haze, and cloudy weather: any obstacle blocking sun light will decrease the energy production of the module. In addition, if a solar panel is partially shaded, the electricity production may stop as the shaded cells will consume the energy produced by the rest of the panel. In some cases, a phenomenon called “hot spot heating” occurs when the shaded portions of a single panel rapidly heat up as they consume electricity from an unshaded part, and can rapidly destroy the panel. This can be prevented by using by-pass diodes which are commonly included in PV modules, but it is highly recommended to check on this feature.

Panel orientation: a poorly oriented panel - for example facing the north in the northern hemisphere - will produce far less energy than the panel is rated for, or even no energy at all.

Temperature: Temperature above 25oC also can decrease the amount of energy produced by a solar panel.

Daylight hours: Solar panels produce more electricity when the vertical rays of sunlight are closer together, providing more energy per square cm. By result, solar panels will produce less electricity as the sun is near the horizon than it will when the sun is directly overhead. In practical terms, a solar panel near the equator that is outside for a 12 hour day will only produce the equivalent of 6 hours worth of peak electricity, and this is only under optimal conditions. Changes to the seasons or bad weather will drop this production even further.

As a result of the aforementioned factors, the actual production of electricity from a solar system can be difficult to evaluate. A simple method is to size the installation so that it produces 30% of the daily energy needs during the worst month.

Mounting Panels and Arrays

WPV modules combined to create solar panels, and solar panels combined mounted together to create solar arrays are possible using standard junction boxes - MC3/MC4 type - that are waterproof and easy to connect. Like batteries, panel arrays should only use solar modules with the same characteristics, the same model, and as far as possible the same history.

Mounts

Solar trackers - devices that orient panels towards the sun - are complex, expensive and not recommended outside of industrial uses and/or high latitudes where the sun moves considerably. Some mounts are designed to allow seasonal adjustment, giving the ability to switch manually between two positions during the year, which should be more than enough

for most installations.

There are essentially two types of solar mounts available: Ground and Roof mounts. Ground mounted solar panels are easier to install and maintain than roof mounted systems. Roof mounted systems are difficult or impossible to adjust and can cause structural damage due to weight and wind pressure. However, ground mounts have their own problems; they occupy usable space, are more prone shade, and run the risk of accidental damage from cars and people. Mounting decisions should be made depending on the location and infrastructure available.

Battery Systems

Solar batteries are crucial to help keep solar systems running. Without battery storage, electricity will only be available while the solar panels are producing it. Since panels only produce energy during the day while consumption may occur at any time, a stable power bank is essential to store this energy. Please reference the [section about batteries](#) for more information.

Solar Regulator

Charger controllers, commonly known as solar regulators are electronic units designed to control the current flow - both the current charging the batteries from the panels, and the current coming from the batteries to offices/compounds.

Solar regulators control the charge and discharge of batteries by disconnecting the panels when batteries are fully charged, and by cutting power to the load when the battery is too low. Another important function of solar regulators is to optimize energy production from the panels by converting the higher voltage output coming from the panels down to the lower input voltage needed by the batteries. The regulator functions as a hub of the installation, and obtaining maximum power output depends on its proper functioning.

There two kinds of solar regulators:

Maximum Power Point Tracking (MPPT):



The MPPT detects the solar panel output voltage and current in real-time and continuously tracks the maximum power ($P=U*I$), regulating the output voltage correspondingly so that the system can always charge the battery with the maximum power. This type of power tracking allows for better power production under cloud coverage and variant temperatures. While more expensive upfront, the MPPT Charge Controller will give more power (and potentially reduce the size of the PV module) and extend the lifespan of the batteries connected to it. Certain controllers even allow connection to smart devices for remote control and monitoring.

Battery Charge Method

Multi-Stage MPPT

Maximum Power Point Tracking (MPPT):

Solar to Electric Conversion Rate 99%

Ampere Rate 30A-100A

Scalability/Range >2KW Large power system

Average Price 120\$

Advantages

- Maximum power point tracking algorithm increases power conversion rate up to 99%.
 - 4 stage charging is better for batteries.
 - Scalable for large off-grid power system.
 - Available for solar systems up to 100 Amps.
 - Available for solar input up to 200V.
 - Offer flexibility when system growth required.
 - Equipped with multiple protection devices.
-

Disadvantages

- High cost, usually twice a PWM.
 - Larger Size than a PWM regulator.
-

Pulse Width Modulation (PWM):



PWM charge controllers can be considered an electric switch between the solar panel and battery packs, programmed to only allow a pre-determined current into the battery. The controller slowly reduces the amount of power going into the battery as the batteries approach maximum capacity. PWM Charge Controllers do not adjust voltage, meaning the batteries and panels must have compatible voltages in order to operate properly. This makes this type of charge controller suitable for smaller solar applications, or for installations that feature lower voltage panels and limited size battery banks. PWMs are a more affordable option but will result in a lower power production from the PV.

Battery Charge Method 3 Stage PWM

Pulse Width Modulation (PWM):

Solar to Electric Conversion Rate 75%-80%

Ampere Rate 20A-60A

Scalability/Range <2KW Small solar system

Average Price 65\$

Advantages

- PWM Regulators have a longer and proven history.
- PWM Regulators have simpler structure and are more cost-effective.
- Easily deployed.

Disadvantages

- Low conversion rate.
- Input voltage must match battery bank voltage.
- Less scalability for system growth.
- Lower output.
- Less protection.

Panel Installation

The storage location of the solar array connected batteries should be identified before sizing and purchasing any equipment. Not only should the space be large enough to mount the required panels, the distance and cable length from the battery storage location will impact the calculated power requirements. Please reference the [section on battery installation](#).

A good location to install a solar array will have the following characteristics:

- Be inside a compound and not visible from the outside. Ground mounted solar panels ideally should be protected by a wall or fence, so sufficient ground space is important.
- Be as close as possible to the battery system.
- Be away from shade, such as trees or buildings.

Sometimes it is difficult to completely avoid shaded areas. The priority should be to avoid shade during the sunniest hours of the day (generally 10am to 16pm). Remember that the position and sizes of shadows change with the seasons.

Solar Panel Position

To optimise energy production, solar panels must be carefully oriented to take full advantage of sunlight exposure. Solar panel pointing includes.

- **Orientation** - Orientation is the angle of the solar panel relative to the north-south axis. Solar panels must face the south in the northern hemisphere and the north in the

southern hemisphere.

- **Tilt** - Tilt is the angle of the solar panel relative to the horizontal plan. Tilt is more difficult to optimise. Latitude can be used as an approximation of the optimal tilt angle, as referenced in the guide below for panels with fixed angles. However, even on the equator panels should have a minimum tilt angle of 5 to 10° to avoid accumulation of water and dust on the panel.

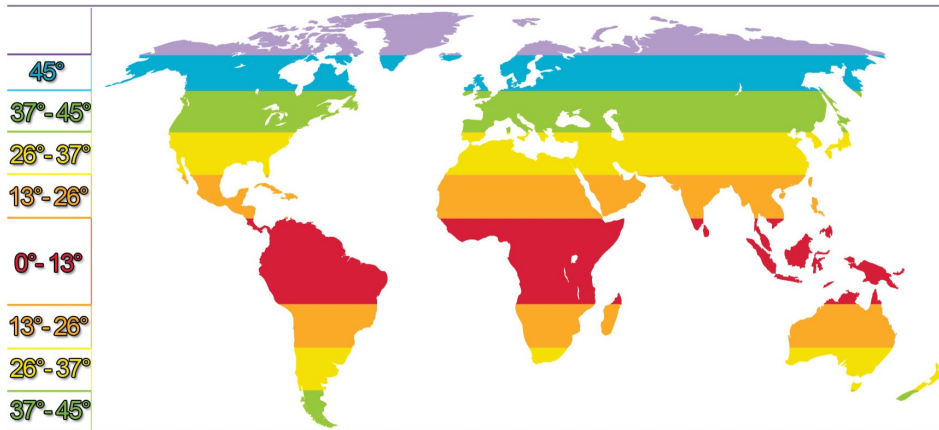

Connection

The output of the solar panels is connected to the solar regulator, while the output of the solar regulator is connected to the batteries. The solar panel mounting frame is connected to the ground, and a grounding/earthing connection is highly recommended for the regulator and surge protector.

Depending on the power or energy required, panels can follow three different schemes that will give different power and current results. Modules connected in series, parallel, or a combination of both will give different power and energy outputs.

Installation Sizing

PV Modules

Below is a simple method of sizing installations so that they produce 30% of the daily energy needs during the worst months of the year:

To cover 30% of the energy needs of an installation, how many solar panels will be needed for:

- A planned power need of 12,880Wh
- An annual average daily production is 4.32kWh per 1kWp
- During the worst month, an average daily production of 2.62kWh per 1kWp

The total actual power production needed per day is:

$$12.88 \times 0.3 = 3.87\text{kWh}$$

At an average daily production of 2.62kWh per 1kWp of module, the total daily need is:

Example:

$$3.87 / 2.62 = 1.48\text{kWp}$$

The actual number of solar panels required will depend on the peak-power of each individual panel. Possible configurations might be:

12 x 130Wp panels
(1.56kWp)

or **9 x 180Wp panels**
(1.62kWc)

or **6 x 260Wp panels**
(1.56kWc)

As there is an annual average daily production is 4.32kWh per 1kWp, 1.48kWp installation will produce $4.32 \times 1.48 = 6.39\text{kWh}$ per day in yearly average, adding to the overall increased energy costs savings.

Regulator

The solar regulator must be sized according to the number and type of solar modules used. Regulator sizing includes:

- The voltage should be the highest possible according to the number of solar modules in the systems.
- Maximum current should be equal to the short-circuit current (ISC) of your solar array. Short circuit current for one individual panel can be found on the identification tag of the panel or in the manufacturer manual. To calculate the short-circuit current of an entire array, combine the short-circuit currents of all panels connected in parallel.

Batteries

Information about Batteries sizing can be found in the section on [installing a battery system](#).

Cables and Protection

Information about cable lengths and wire gauges can be found in the chapter [electrical installations](#).

Safety and Security

Photovoltaic panels produce electricity just like a regular generator. Though the production method may be different, and depending on the size of the array the overall Wattage less than a generator, solar arrays can still produce harmful amounts of electricity.

Handling

Whenever persons must handle a PV solar panels they must wear the proper [protective clothing](#) and equipment at all times.

More importantly - PV solar panels produce an electrical current, even when they are not connected to any other device! As long as a panel is partially exposed to light, it will be producing some form of current and can still pose a risk. A panel producing electricity will not make a noise or vibrate, and may not even be warm to the touch. Usually PV solar panels have no form of indicator that they are producing electricity at all. For this reason, PV solar panels tend to look safe to the touch, even when they may not be.

When installing, removing, or simply adjusting solar panels, they should be completely covered. If possible, work can also be done at night time. When carrying or handling solar panels, handlers should note all electrical connector outputs on the side, avoiding making accidental contact with them. Consider all wires coming from a solar panel the same as a live wire coming from a powered grid or live generator.

Security

PV Solar panels should always be in a secure location, just like generators and batteries. The orientation of buildings and vegetation may make this a difficult task, but planners should consider access control.

- If possible, install panels on roofs of buildings, and in areas where persons do not frequently visit - avoid roof top terraces or resting areas.
- Install solar arrays inside of compound spaces, inside the safety of a perimeter wall wherever possible. Even if arrays are inside a compound wall, there should be some form of signage and barrier fencing to prevent visitors or casual labour from accessing the area.
- If solar arrays are installed in the open or in remote locations, then a separate security fence or wall will need to be built around the outside. The equipment is expensive, but it can also harm humans and animals passing by. Persons unfamiliar with solar panels may be drawn close out of curiosity, so signage must be posted in the appropriate local language.

Energy Consumption Calculator

Energy Demand

General Data

Country	<input type="text" value="-- select --"/>
Temperature	<input type="text"/> °C
Altitude	<input type="text"/> m

General Data

Solar daily irradiance kWh/m²/day

Calculation Settings

Local rated voltage	n/a Vca
Local frequency	n/a Hz
There is any 3-phase Consumer in the installation?	<input type="checkbox"/>
The installation provides power to a hospital (very sensitive structure)?	<input type="checkbox"/>

Appliance/Device	Quantity	P (W)	S Max (VA)	S Avg (VA)	Working Hours				E
					Morning	Midday	Afternoon	Evening	
<input type="button" value="Add row"/>	<input type="button" value="Remove last"/>	<input type="button" value="Reset"/>							

- General
- Generator
- Battery
- Solar

Estimation of Needs

Energy Consumption per Day

Total	n/a W a day
Low consumption devices (Class 1)	n/a W a day
High consumption devices (Class 2)	n/a W a day
Usefull energy / day	n/a Wh
Usefull energy / night	n/a Wh

Power Needed

Total	n/a VA
Low consumption devices (Class 1)	n/a VA
High consumption devices (Class 2)	n/a VA
Average power necessary	n/a VA

Generator

Additional Information

Additional Information

Voltage specification (single-P / 3-P)	Automatic selection ▼
Cable length between:	
the generator and switchgear	10 m ▼
the grid and switchgear	10 m ▼
the switchgear and the main electrical dashboard	10 m ▼
Wire Gauge recommendation:	
between generator and switchgear	n/a mm ²
between grid and switchgear	n/a mm ²
between switchgear to dashboard	n/a mm ²

Size Recommendations

Size recommended (PRP)	n/a KVA
Power (ESP)	n/a VA
Voltage type	n/a
Rated voltage	n/a V
Rated frequency	n/a Hz
Output circuit-breaker size	n/a A
Estimated fuel consumption	n/a l/h
Estimated oil consumption	n/a l/h
(1 oil change every 250h)	n/a l/250h

Battery System

Additional Information

Unit voltage	12	V
Unit capacity	1000	Ah
Authorized discharge ratio (no less than 40%)	50	%
Charge available time (minimum 4hours)	4	h
Days of autonomy needed if no charge	1	

Recommendation

Energy to accumulate	n/a Wh
Voltage recommended	n/a V
Number of batteries needed with the specifications provided	n/a units
Type of conection	n/a
Circuit breaker ideal size	n/a A
Charger size at least	n/a A

Solar System

Solar System

Additional Information

Solar daily irradiance	n/a kWh/m ² /day
Usefull max power per day	n/a Wc
Regulator size	n/a A
Solar panels unit voltage (recommendation: n/aV)	12 V <input type="button" value="v"/>
Solar panels unit max power	<input type="text"/> Wc

Recommendation

Minimum number of solar panels	n/a
Recommended number of solar panels	n/a
Solar charge controller: type of regulator	n/a
Solar charge controller: rated voltage	n/a V
Solar charge controller: unit max current	n/a A
Solar charge controller: quantity	n/a

[Open in full view](#)

Energy Tools and Resources

Templates and Tools

[Guide - Cable Sizing Chart](#)

Sites and Resources

- [Sphere Standards](#)
- [SparkFun](#)
- [SolarGis](#)

References

- RED R, (2002). Engineering in emergencies
- [MEDICINS SANS FRONTIERS, \(2007\). Electricity Support.](#)
- [ENGINYERIA SENSE FRONTERES, \(2006\). Tecnologías de la energía para el Desarrollo.](#)
- [MEDICINS SANS FRONTIERS, \(2004\). Energy Guideline](#)
- [ACTION CONTRE LA FAIM, \(2012\). Generator Guideline](#)
- MEDICINS SANS FRONTIERS, (2002). Power Supply.
- [ACTION CONTRE LA FAIM. \(2012\). Energy management Guideline](#)
- SAVE THE CHILDREN. Electricity distribution, generation and renewable energy guide.
- [ACTION CONTRE LA FAIM, \(2020\). Solar pumping, Electrical design and installation.](#)
- INTERNATIONAL COMITEE OF THE RED CROSS and MEDICINS SANS FRONTIERS, (2016). Electrical installation and equipment in the field, Rules and Tools.

- BP, (2000). Solar installation manual
- [MEDICINS SANS FRONTIERS, \(2012\) Electrical safety guidelines](#)