

# Transportation

## The Role of Transport

In the humanitarian context, transport is defined as:

“ **The activities involved in moving supplies from point of origin to internal customers or beneficiaries**”.

The role of transport is to facilitate the movement of physical goods. In the humanitarian context, this might include:

- Transport from manufacturing facilities, donors, and storage or pre-positioning locations
- Delivery to regional warehouses, country level warehouses, offices and distribution points
- Carriage between warehouses, hubs and field locations

The source and destination may be in the same country, or one may be in a different country requiring international movement.

The rapid growth of technology and the changes in the delivery of humanitarian aid has done little to change the fact that relief supplies still have to be collected and delivered via some physical form of the transmission. Even though new technologies have enhanced the speed at which cargo can be transported or monitored, the basic concepts surrounding transportation have remained largely the same for many years.

Historically, the transportation of supplies has been regarded as an ancillary function of little or no central importance. More recently, efficient transportation has been recognised as an essential determinant in providing consistent, quality service to beneficiaries. A good transport system fulfils the "rights" of supply chain management. That is:

- The right good.
- Delivered to the right recipient.
- In the right quantities.
- In the right condition.
- At the right location.
- In the right time.
- For the right price.

In an ideal scenario, goods will arrive as scheduled, at the right price, in maximised loads with no breakages or pilferage.

Summarising this thinking into a series of actionable steps, and successfully implementing those steps, will ensure timely and effective delivery of humanitarian assistance. A good transport system complements an efficient distribution system.

## Common Terms in Cargo Transport

### **Shipper**

The person or legal entity that is sending the goods from point of origin. The shipper does not have to be the owner of the cargo. The shipper can also be referred to as the sender.

---

<b>Carrier</b>	The person or legal entity that either owns the vehicle or vessel upon which cargo is transported - or "carried" - or has legal responsibility for physically stewardship of the cargo between two points.
<b>Receiver</b>	The person or legal entity that is duly authorised to receive cargo on the receiving end. Receivers are also sometimes called "consignees," however the term consignee has specific legal meaning in customs proceedings, while a receiver is more generic could take possession of cargo through a variety of means, domestic or international.
<b>Agent</b>	A person or legal entity who is legally and contractually designated to act on behalf of a shipper, carrier or receiver. Agents can act in a variety of functions, from handling goods to processing documentation.
<b>Service Provider</b>	Any contracted third-party entity that offers a service, usually on a for profit basis. A service provider may be involved in a variety of activities, including being an acting agent or a contracted carrier.
<b>"Take Possession"</b>	When physical goods are transmitted into the direct care and stewardship of one party, be it a transporter, a warehouse, or customs, that party is said to have "taken possession" of the cargo. Taking possession does not mean the party holding the cargo then owns the cargo, they are only physically holding it for their part of the transport process.
<b>Intermodal</b>	Any form of transport that changes between two or more modes of transport. Intermodal transport can be facilitated through the use of containerised shipment, however cargo can also be transported through intermodal means simply by directly loading and offloading through a variety of means.
<b>Material Handling Equipment (MHE)</b>	MHE is any form of mechanical equipment used to facilitate the loading and offloading of cargo, or the movement of cargo around an open space such as a port or a warehouse. MHE includes forklifts, cranes, pallet jacks, and more.
<b>Incoterms</b>	Incoterms - "International commercial terms" - are mutually agreed upon international shipping terms that designate responsibilities, risks and limitations of shippers, carriers and receivers. Incoterms generally are only applicable and enforceable for international shipments.

## Managing Transport

### Developing a Transport Strategy

A transport strategy in a humanitarian context varies from one organisation to another and from one situation to another. and is largely dependent on the needs of the response. Some factors to consider when developing a transport strategy are:

- How to identify transport service providers.
- How to manage transport – self managed or third-party provided.
- Capacity of transport modes available.
- Quantities of goods requiring movement over time.
- Nature of goods/products/supplies to be transported.
- Distances to be covered.
- Environmental issues such as climate, government legislature, and infrastructure.
- Number of destinations, hubs and pre-positioning locations.

- Origins, routes, and destinations.
- Available transport modes & their relative costs.
- Human resources available.
- Security along the transport route.
- Special circumstances, such as the nature of disaster.

The above factors would be valid for both emergency and non-emergency situations.

Transport management in emergencies can be a complex task depending on the nature of the disaster. Humanitarian organisations have increasingly begun to use the joint transport services as a strategy in emergencies, such as those implemented by the Logistics Cluster during emergencies. A joint transportation service is based on a collaborative approach and aims to leverage the advantages of centralised coordination and sharing of assets.

## Organizing Transport

In emergency contexts, transport can logically be divided between domestic/local transport and international transport. The general concepts around domestic and international transport remain largely the same, however special considerations are required for both.

**Domestic transport movement** - Local movements within a specific country will usually involve road transport, however rail, air, river and even at time sea transport can occur in domestic movement. This may involve movement of palletised/bulk loads from ports, airports and rail-yards to warehouses and depots, palletised/bulk movements between facilities such as warehouses or depots, or delivery of smaller consignments from a local warehouse or depot to end users at a number of destinations in an area. Domestic transport requires actors to follow all local laws and safety regulations.

**International movement** - International transport requires the transmission of physical goods across a legally defined international border or boundary, and in most normal circumstances requires undergoing standard customs procedures. The local market will not always be able to provide all the products and services required to fulfil the needs identified in an emergency response. Response agencies will therefore source goods externally and organise the transportation of relief supplies to affected locations. To ensure efficiency and compliance with import regulations the organisations seek service providers with expertise and capacity to handle certain aspects of the movement.

## Mode of Transport

A mode of transport is the means by which goods and material are transferred from one point to another. The basic modes of transport are:

1. [Air](#)
2. [Sea / Riverway](#)
3. [Road](#)
4. [Rail](#)

See below a mode comparison matrix for different modes.

	<u>Road</u>	<u>Rail</u>	<u>Sea/Riverway</u>	<u>Air</u>
<b>Relative Speed</b>	Moderate	Moderate	Slow	Very High
<b>Reliability</b>	Good	Good	Limited	Very good
<b>Cost per kg</b>	Medium	Low/Medium	Low/Very Low	High
<b>Flexibility</b>	High	Low	Low	Medium
<b>Other Considerations</b>	Extensive Network Short and medium distances from neighbouring country to operation site; internal transport for short and medium distances	Limited and fixed infrastructure Large consignments from port of discharge to inland operation site; ecological	Restricted Network Large quantities; less urgent; pre-positioning phase; long distances with no time constraint	Limited Network Emergency phase; perishable goods; fragile or perishable goods; cold chain; no alternative option; small shipments; e.g. diplomatic pouches; long distance with time constraint.
<b>Advantages</b>	Relatively fast; no transshipment; direct delivery; flexible; cost	Economical; large loading capacity; range and speed (context depending)	Economical; large loading capacity; no restriction on loading capacity; cheap	Fast; reliable; limited loss; direct; easy tracking and tracing
<b>Disadvantages</b>	Roads may be dangerous or blocked; sometimes driver nationality or vehicle registration not acceptable	Difficulty finding freight cars; frequent delays; transshipping required; inflexible; limited tracking	Slow; transshipping at ports; use as a second means of transport at high volumes; higher theft risk in ports; not flexible	Expensive; restricted to journey's between airports; restricted loading capacity; special considerations (dangerous goods, size and packing, etc.)

In emergencies, the criteria of speed and reliability must be examined when considering the choice of mode. Different modes have quite different characteristics and will need to meet the speed/reliability/cost criteria to varying degrees. The appropriate mode must be carefully selected if it is to match all the requirements. Multi-modal solutions may provide the most effective and efficient transport option.

Whilst the physical characteristics of certain goods and supplies may determine a specific mode of transport, most goods will be capable of being moved by a variety of modes. Customer requirements and constraints on the organisation providing the transport must be considered. In humanitarian aid situations, it is often environmental factors, such as the destruction of roads and railways that have a significant impact on mode selection.

It is important to fully recognise the operational characteristics of the mode or modes that

have been selected. It is also necessary to consider the type of vehicle or equipment that will be used within that mode. Prior to making a decision on the mode of transport, it would be useful to create a matrix ranking of influential factors for choosing transport modes. Some factors to consider in the rating:

- Required delivery date
- Cost of transport service
- Reliability and service quality
- Shipment size and item type
- Anticipated transit time
- Number of transshipment points
- Range of different services offered by a third-party provider
- Modes that realistically cannot be considered should be ruled out of the decision process immediately
- Geographical factors should be considered, as they may remove the opportunity to use a particular mode
- Lack of appropriate infrastructure may also remove the opportunity to use a particular mode

## Standard Documentation

Outside of highly specialised forms of documentation utilised for different modalities of transport, there are several widely accepted documents used in virtually all methods of transport. The purpose of utilising widely accepted documents is enact some form of traceability and accountability for cargos in transit between all parties who may handle or store the cargo. Widely accepted cargo tracking documentation methods should not be confused with the wide variety of specific documentation required for customs clearance. Customs clearance documents are generally required to certify conformity with national laws, help facilitate tariff revenue, and may be different from country to country. At the very least, agencies should consider using some form of the below documents for all shipments, even domestic shipments between their own managed facilities:

**Waybill** – A waybill is the ultimate informal “contract” between the sender, the carrier and the receiver of goods. A waybill should contain all relevant information for the shipment itself, including:

- The contents of the shipment.
- The point of origin and destination.
- Names of the shipper/sender, the carrier/driver, and the intended recipient.
- Dates of the transaction.
- Important information pertaining to the goods; special handling requirements, delivery instructions, etc.

When issuing waybills, one copy should stay with the sender, and at least two copies should travel with the carrier. When cargo is delivered on the receiving end, one of the copies travelling with the carrier should stay with the receiving party providing a transparent paper trail of what should have been on the vessel/vehicle and when it arrived to whom. Ideally, the sender will fill out and generate the waybill, the transporter will cross check contents and confirm the items are correct, and the receiver will cross check and confirm again, noting any discrepancies. Some aid agencies prefer to receive a copy of the waybill signed by the receiver before closing the books on that individual shipment. If a third-party transporter is used, agencies may withhold payment until the countersigned waybill is received in good order. Waybills may also sometimes be referred to as “cargo manifests.”



contain an overview of the goods, while placing more emphasis on data surrounding who and when the consignment changed hands. A packing list should contain as much or as little information required to successfully convey the full state of the goods in the consignment.

**PACKING LIST**

Page 1 of 1

ORGANIZATION LOGO

<b>Sender:</b> Address: _____ Contact Name: _____ Tel: _____ Email: _____	<b>Consignee:</b> Address: _____ Contact Name: _____ Tel: _____ Email: _____	Date: _____ Invoice Reference No.: _____ Waybill Reference No.: _____
---	--	---

Item Description / SKU	Unit Type <small>(unit, pallet, etc.)</small>	Number of Units	Dimensions (cm)			Unit Volume (m <sup>3</sup> )	Unit Weight (kg)	Unit Value (USD)	Batch/Lot	Expiration Date	Total Item Volume (m <sup>3</sup> )	Total Item Weight (kg)	Total Item Declared Value (USD)
			L	W	H								
1													
2													
3													
4													
5													
6													
7													
8													
9													
10													
11													
12													
13													
14													
15													

Name: \_\_\_\_\_

Signature: \_\_\_\_\_

Total Volume (m <sup>3</sup> )	Total Weight (kg)	Total Declared Value (USD)

Title

Download - Packing List

File



**Invoice / Proforma Invoice** – Invoices and Proformas are typically only applied when goods are coming from a vendor, or when goods are physically transported across a national border. For domestic movements, the invoice largely contains financial information relevant to the consignment, and should designate if goods have been paid for or not. Proformas are largely only used when attempting to obtain duty free status during import, and as such aid agencies will only likely be producing proformas during the customs phase.





sourced.

The selection process adopted for the acquisition of all services is covered by the organisation's approved procurement policy, processes and procedures. Ideally, contracting should be done in a competitive manner, on market terms, and negotiations undertaken in an open and transparent fashion, thus ensuring cost effectiveness and equal opportunities for the appropriate commercial entities.

There has also been an increasing level of attention to the ethical standards of contractors, including their facilitation and participation what would be considered violations of state and national laws, human rights abuses, or their involvement with parties to conflict.

### **General Transport Service Provider Selection Criteria**

The criteria for selection will vary from organisation to organisation. Some factors that may influence the selection of transport service providers are:

- Carrier characteristics and capacity.
- Proven efficiency.
- Timeliness of delivery.
- Known integrity, reputation and reliability.
- Good relationships with other carriers.
- Financial viability to cover costs of providing the service.
- Ability to provide a multi-modal service, if need be.
- Presentation of timely reports and correct invoices.
- Licensed by the government to conduct customs clearance formalities and be up-to-date on changes in customs requirements.
- Own or have access to a bonded warehouse to protect and control shipments in transit.
- Own a trucking fleet for inland transport and have access to specialised vehicles when needed such as container trucks, low-bed trailers, tankers, etc.
- flexible in their availability at short notice, also outside of office hours and on public holidays.
- Have influence in the transport market, with port authorities, etc.
- Experienced in successfully handling duty exemption arrangements for humanitarian organisations.
- Have an office in the port area or nearby.
- Have at least a country-wide, preferably a multi-country regional network.
- Use technology effectively, including a good telecommunications system and, preferably, a computerised tracking system that allows visibility of where shipments are at a given time.

## **Typical Service Providers**

Although it is advisable to use an intermediary such as a freight forwarder or clearing agent to handle international movements, it is still important to have a basic understanding of the roles of other third-party service providers involved in international movement.

**Private Transport Companies** - Private companies that own and operate vehicles such as trucks or planes directly. Many private transport companies have direct sales and customer service components, in particular small scale, local transport companies. Other companies, such as major airlines may not have the time or capacity to manage direct customer sales, and prefer to go through brokers or forwarders. A direct relationship with a transport company can certainly save costs, but for any services that require complex intermodal solutions that may

not all be owned by the same company, or in situations where customer service is inadequate, contracting forwarders might be the best solution.

**Freight Forwarders** – Commercial third-party companies or individuals that act as brokers between transport companies, customs agents, logistics providers, and other commercial services that might support packaging/handling, warehousing, transportation, or any other aspect of moving material goods from one place to another. Unless a requesting agency has well defined transport routes and a detailed understanding of the shipping market, freight forwarders are essential for identifying and pricing transport options, especially in chaotic post emergency settings. Forwarders have contacts within the transport communities and know how where to look for the best shipping options.

**Clearing Agents** – Commercial third-party companies or individuals who specialise in understanding import and export regulations, and help facilitate the flow of material goods through customs. Though clearing agents may be used for import or export, the majority of their services are employed for getting goods into countries. Import and export regulations are complex and the failure to comply can result in fines or other difficulties. Many countries require an official licensing process for clearing agents, and unless organisations have specific expertise in customs agents should always be consulted for imports of any kind.

**Inspection Services** – Private third-party services that conduct inspection on goods in transit. This may include physical counting, damage inspection, laboratory testing, inspection of batch/lot/expiration, validating specifications, etc. Inspection services may be required for importation, but many agencies employ inspection services during upstream transport, especially at the point of procurement.

**Third Party Logistics Provider (3PL)** – Commercial third-party logistics providers that can assume a portion of or the entire supply chain. 3PLs can act on behalf of contracting agencies for a variety of services, including warehousing, kitting, procurement, quality inspections, transport and even developing supply chain strategies without providing a physical service. 3PLs tend to be more expensive, but can offer holistic solutions to agencies who may need additional support.

The aforementioned service providers are all for profit companies, and as such the regular procurement process for each respective agencies should still be applied. It is generally recommended that agencies obtain multiple quotes, review performance, and incrementally conduct new bid analysis.

Other related parties frequently encountered with cargo operations are:

- **Customs Officials** – Agents designated by the national authority of countries to facilitate the lawful transmission of items into incorporated national territory.
- **Airport / Sea Port Authorities** – Government lead or appointed authorities who oversee the safe and efficient operation of ports of entry, including coordinating positioning and movement of vessels and aircraft and ensuring security measures are enacted on behalf of the national authority in question.
- **Ground Handling Agents** – Government run or privately contracted services who manage ground handling at airports and seaports. Ground agents are usually sub contracted and coordinated by forwarders or the airlines, however occasionally humanitarian agencies may need to liaise directly with them to solve problems.

## Planning and Scheduling Movement

Routine movements, taking place on a regular basis, need to be planned at the outset. Non-

routine movements occurring on an ad-hoc basis will have to be planned when the need arises. Ideally movements should be planned and managed by a transport office or dedicated focal point responsible for determining the appropriate routing for the goods, allocate resources (own or contracted) and inform the destination of estimated delivery time. During movement designated focal points will track the progress of the goods and update delivery times accordingly and will manage the staff involved in the movement and deal with any issues that arise. They will also handle any problems that occur during the movement, liaising with contractors, freight forwarders and shippers as required. The transport office may have to produce the required documentation to cover transit, alternatively they will be responsible for collecting the required documents together for dispatch.

Once movements have been planned and are initiated, it is important to maintain an information flow between all parties involved to ensure the safety and security of the goods and the adherence to service as promised. In environments within which humanitarian aid organisations operate, many events can impact the efficient movement of goods. In natural disaster or conflict zones, the risk to the movement is potentially high. Having up-to-date information on the status of the movement allows problems to be quickly identified and dealt with. Movements in a national context can usually be managed more closely than movements between or across countries. National movements can be usually planned and coordinated more easily while international movements will often be managed by one or more third parties, working in different time zones and in different languages. Often, international movements are planned and managed by a freight forwarder or logistics service provider working within the broad plan to meet the client requirements in terms of movement time and routing.

In addition to identifying the primary methods of transport, aid agencies should consider the smaller intermediary steps. As an example, even though an agency may be able to identify an international air transport method into a country, will there be available trucks to adequately pick up and transport cargo from the airport of reception? The same applies for multiple steps in the process, including the ability to identify adequate warehouse space, the ability to understand and comply with import regulations, and generally be able to accommodate all steps of the supply chain, not just the one step in question. Frequently, aid organisations are operating in a “push” model early in a disaster, and persons associated with organizing upstream transport are not necessarily taking directions from or even communicating with the persons engaged in downstream planning. Proper planning throughout all stages is vital to a good transport strategy.

## **Cargo Insurance**

Insuring cargo while in transit can be complex for aid agencies, especially when multiple forms of transport are involved across multiple countries, and into areas of heightened risk, such as natural disasters or protracted armed conflicts. For many agencies, the single largest expenditure of their response activities is the pipeline of relief items heading to affected populations, and proper care should be invested into maintaining this pipeline through risk mitigation measures. Generally there are two approaches organisations use for insuring cargo:

- Relying on insurance provided by the third-party transporter
- Developing a self-managed insurance plan

The risk of using a self-managed or third-party transport provider in the required area must be assessed prior to the appropriate insurance being taken out. In moving goods – especially to and within high risk contexts - there will be potential risks of theft or loss of the goods.

## Third-Party Transporter Insurance

Transporter provided insurance can be useful in that it provides coverage for short term gaps, for specific activities that self-insurance isn't designed for, or last mile activities that have enhanced risks. Cargo may be covered by the overall shipping terms of a contract with the third-party transporter, but it is strongly advised that all organisations relying on third-party transporter provided insurance to confirm the insurance status and requirements with the sender/owner of the goods to be moved. Shippers should understand the level of insurance that the provider will offer to cover the goods it carries on behalf of its clients; often if any insurance cover is offered, it will be fairly nominal and only cover a portion of the real cost of the items.

To ensure that freight insurance is properly applied, the full real value of the cargo must be declared to the third-party transporter prior to shipping and the costs and inclusion of insurance must be transparent, being included on any invoicing, and partially expressed through the Incoterms when in use. Many shippers also include the value of the transportation itself as part of the "value" of goods, as any loss or damage due to accident or negligence on behalf of the transporter will also result in the lost cost of the transport service itself. If a catastrophic loss should occur, ideally the shipper will be able to recover the full value without external litigation. Shippers should express a desire to insure cargo through the carrier/third-party when soliciting transport from brokers and forwarders to ensure service is available up front, and normally third-party or carrier provided insurance is negotiated through the forwarder.

There may be instances where organisations develop long term transport contracts with third-party providers, through which the shipper may not know the full value of every shipment over the contracted period. Such arrangements might be common in landside trucking contracts, which might go for a year or more over a changing response. If organisations wish to utilize insurance provided through the transporter in this case, they will need to develop a strategy to account for potential values of future cargo. This might include designating a maximum ceiling of coverage for any given movement that is roughly equal to or higher than any possible load, or develop a scheme through which cargo value is declared per movement and the third-party transporter adjusts billing accordingly. organisations should never assume long term contractors will factor different insurance needs into quoting, and should be transparent in the bid process to avoid confusion later on.

Individual cost of third-party provided insurance may be influenced by the reputation of the transporter. In setting up contracts with providers, it is important that the type of insurance be clarified and incorporated in the contract terms. If there is any doubt as to the cover provided, advice from the organisation's office handling insurance should be sought. If insurance costs differ for different transporters, these should be included in the overall cost comparison matrix.

Key elements organisations should consider:

- Type of insurance: What is covered and to what extent, and where do responsibilities start and stop for the transporter?
- Duration of insurance coverage
- The overall process for reimbursement and payment

For long term, open-ended contracts:

- Scope: does the insurance cover all potential contexts of operation? What if a transport

- requires operating in more than one country?
- Does the insurance accommodate changing risk conditions?

## Self-Managed Insurance

Some humanitarian agencies have opted to develop a global self-managed insurance schemes in the form of self-insurance or some form of “blanket insurance.”

A self-insurance scheme for cargo requires a fairly robust accounting system, whereby organisations intentionally add costs to budgets for cargo movement, but simply keep a small portion of that money in a separate, global pot which can be paid out in case of cargo loss. Self-insurance is useful in that it is quick and efficient and doesn't require dealing with outside brokers, however it requires a great deal of internal control and analysis. Smaller agencies or agencies that have fluctuating size and types of activities may not be able to adequately predict their global self-insurance needs, and may end up facing substantial global losses.

A method of obtaining global blanket cargo insurance might come from soliciting large international insurance brokerages, who may be able to provide a flat or relatively fixed rate for cargo insurance based on their estimation of risk of any individual agencies' activities. Global cargo insurance might end up being slightly more expensive per kilogram, but saves substantial amount of time identifying insurance solutions for every transport. The specifics of a global insurance plan would be negotiated based on the need of the requester. As an example, if an aid agency maintains a large fleet of self-managed cargo vehicles in many high-risk countries, there may be a need to develop a high annual global premium to cover all risks associated with cargo movement. On the other hand, if an aid agency is largely only doing international transport using regular carriers, then insurance may be issued on a case by case basis.

## Incoterms

[International Commercial Terms \(Incoterms\)](#) used in international contracts of sale are widely agreed upon, pre-defined commercial terms for defining limits of risk, cost and liability for any form of international transport, detailing the roles and responsibilities of the shipper, the carrier and the receiver/consignee. Incoterms are negotiated and set by the [International Chamber of Commerce \(ICC\)](#), and are connected to various forms of international trade law and maritime time. Incoterms were established in the 1920s, and are now generally updated every ten years, with the most recent update in 2020.

Incoterms function as a short hand for all parties involved with an international shipment, and allow for different parties to quickly reference and understand where their obligations lie. The shipper in this context may be the supplier of goods, or it may be the party purchasing the goods and arranging for transport. The contracted carrier transporting the goods may only function as a broker or intermediary, but will be able to reference Incoterms when dealing with the shipper to fulfil its obligations. organisations that are planning international procurement and shipment should seek to include Incoterms in both their procurement and transportation contracts.

Incoterms cover all forms of international transport, however there are special inclusions for sea shipping only. the current reference point for shippers is Incoterms 2020, however sellers and carriers may agree on older versions of Incoterms insofar as all parties are aware of what terms they are referencing when talking about procurement and transport. A copy of the 2020 Incoterms chart can [be downloaded here](#).

## Incoterms 2020 for All Forms of Transport:



A general description of all-mode Incoterms:

**EXW**  
**Ex-Works** Buyer takes possession of goods at the seller's premises or at another named place (i.e., warehouse, etc.). The seller is not obligated to load the goods on any collecting vehicle nor does it need to clear the goods for export (where such clearance is required).

**FCA**  
**Free Carrier** Seller turns over possession of the goods to the carrier or another entity designated by the buyer at the seller's premises or another named place. The named place of transfer must be clearly identified; the risk passes to the buyer at that point.

**CPT**  
**Carriage Paid To** Seller turns over possession of the goods to the carrier or another entity designated by the seller at an agreed place. The seller must contract for and pay the costs of carriage necessary to bring the goods to the agreed place of transfer.

**CIP**  
**Carriage and Insurance Paid To**

The seller turns over possession of goods to the carrier or another entity designated by the seller at an agreed place. The seller must contract for and pay the costs of carriage necessary to bring the goods to the agreed place of transfer. The seller contracts insurance cover against the buyer's risk of loss of or damage to the goods during the carriage. Under CIP the seller is required to obtain only minimum cover insurance. Should the buyer wish to have more insurance protection, it will need either to agree expressly with the seller or to make its own extra insurance arrangements.

**DAP**  
**Delivered at Place**

The seller transfers goods to the possession of the buyer on the arriving means of transport (vessel, aircraft) ready for unloading at the named place of destination. The seller bears all risks involved in bringing the goods to the named place, including insurance.

**DPU**  
**Delivered at Place Unloaded**

The seller transfers possession of goods to the buyer, once unloaded, at a named place of destination. The seller bears all risks involved in bringing the goods to, and offloading at, the named place of destination, including insurance.

**DDP**  
**Delivered Duty Paid**

The seller delivers and transfers possession of the goods to the buyer, cleared for import on the arriving means of transport (truck, vessel, aircraft) ready for unloading at the named place of destination. The seller bears all the costs and risks involved in bringing the goods to the place of destination and has an obligation to clear the goods not only for export but also for import and to pay any duty for both export and import and to carry out all customs formalities.

**Incoterms for Seaborne Freight Only:**

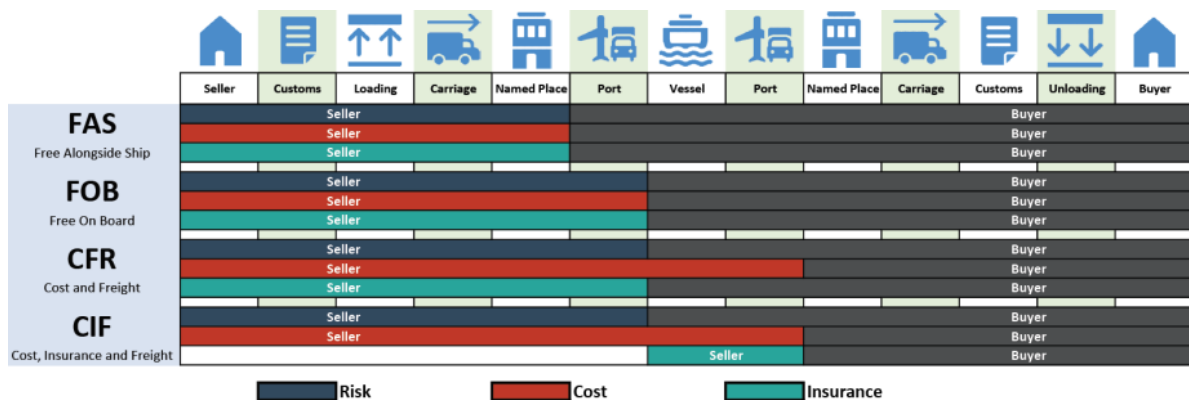

A general description of seaborne freight only Incoterms:

**FAS**  
**Free**  
**Alongside**  
**Ship**

The seller turns over possession when the goods are placed alongside the vessel (e.g., on a pier or a barge) nominated by the buyer at the named port of shipment. The risk of loss of or damage to the goods passes when the goods are alongside the ship, and the buyer bears costs from that moment onward.

---

**FOB**  
**Free on**  
**Board**

The seller turns over possession of the goods on board the vessel nominated by the buyer at the named port of shipment. The risk of loss or damage to the goods passes when the goods are on board the vessel, and the buyer bears all costs from that moment onward, including insurance.

---

**CFR**  
**Cost and**  
**Freight**

The seller turns over possession of the goods on board the vessel. The risk of loss of or damage to the goods passes to the buyer when the goods are on board the vessel, however the seller must contract for and pay the costs and freight necessary to bring the goods to the named port of destination.

---

**CIF**  
**Cost,**  
**Insurance**  
**and**  
**Freight**

The seller turns over possession of the goods on board the vessel. The risk of loss of or damage to the goods passes to the buyer when the goods are on board the vessel. The seller must contract for and pay the costs and freight necessary to bring the goods to the named port of destination. The seller also contracts for insurance cover against the buyer's risk of loss of or damage to the goods during the carriage, however the seller is only required to obtain minimum cover insurance. Should the buyer wish to have more insurance protection, it will need either to agree as much expressly with the seller or to make its own extra insurance arrangements.

---

Title

Download - Incoterms 2020

File



## Packaging and Labeling

### Packaging

Shippers should be aware of several potential problems when packaging cargos for any form of transport:

- Breakage.
- Moisture.
- Pilferage.
- Excess weight.
- Spoilage/Expiration.
- Temperature sensitive items.

Any and all packaging should meet the needs of the shipped item, the recipient, the duration of the transport, and the method of shipping. Packaging should:



- Meet shipping regulations.
- Ensure proper handling.
- Conceal the identity of the contents (where appropriate).
- Help receivers identify shipments.
- Insure compliance with environmental and safety standard.

Not only does the cargo need to be adequately packed but instructions be given to all parties handling the cargo at some stage of the venture to ensure safe delivery.

### **Packaging Types and Terms**

- **Outer Packing/Outer Packaging** - The outer most enclosure that contains or prevents unintended release of contents
- **Over-Packaging/Overpacking** - Items that are packaged in more than one layer or enclosure. Example: A box within a box, or multiple sacs within a larger carton. Over-packaging is common in handling of [dangerous goods](#).
- **Handling Unit** - The lowest unit at which cargo is handled, usually at the box or carton level.
- **Unit of Accounting** - the lowest level inventory unit that is tracked and accounted for.
- **Shipping Unit** - the lowest unit at which cargo is handled for shipping - may be the same as the handling unit, or may be accounted for at the pallet/Unit Load Device level.
- **Common Package Types**
  - Bale/Bundle
  - Carton/Box
  - Roll
  - Pallet
  - Set/Kit
  - Crate
  - Drum
  - Bag/Sack
  - Loose/Bulk/Individual Unit

### **Labelling**

Labelling for transport is an important consideration. Knowing that cargo is often broken down or shipped loose means that shippers must adequately mark cartons to facilitate tracking of cargo, especially for cargo transported by air. Insurance brokers also have the right to dishonour a claim of damage to goods, due to inadequate packing and marking for the selected mode of transport. It is strongly advised that all cargo intended for air transport be labelled at the level of the carton or handling unit, and should have some - if not all - of the corresponding data:

- Shipper.
- Logo of agency.
- Intended Destination.
- Items in package (if required)
- Packing List Number/Consignment Number.
- Weight and measurement of the package.
- Package contents (if appropriate to list externally without fear of pilferage).
- Numbered "Package 1 of X".
- Special handling requirements (temperature control, fragile, etc).
- [Dangerous goods](#) contained within.

Properly labelled packages will help reduce loss while in transit. Professional freight forwarding services tend to be extremely good at keeping large consignments together throughout the course of an air movement. Depending on the arrangement with the forwarder, large consignments can be split into multiple smaller shipments, and will be re-consolidated prior to delivery. In emergencies however, movement can be chaotic and cargo frequently delayed or lost. The more visible and easily identifiable relief cargo is, the more likely it is to reach its final destination.

[The International organisation of Standardisation \(ISO\)](#) has designed graphic symbols that are placed on packing units to instruct cargo handlers how to handle the cargo. These symbols are used worldwide and is a common language understood by all.

Any and all cargo containing dangerous goods being packaged for transport should be properly labelled according to the equivalent standard of the method of shipping. Information on proper labelling of dangerous goods of can be found in the [dangerous goods section of this guide](#).

## Air Transport

Air transport is by far the most time efficient mode of transporting goods, and in humanitarian contexts is used both domestically and internationally. Unfortunately, along with the speed and efficiency of air transport comes significantly higher costs and far more restrictions and complexities on handling of goods. In emergencies, and especially natural disasters and conflict situations where road access is difficult, air transport is often the preferred alternative.

## Common Terms in Air Transport

<b>Fixed wing</b>	The most common type of aircraft – any airborne vessel with wings that requires horizontal take-off and landing space.
<b>Rotor wing</b>	Helicopters of any configuration that have top mounted rotors to provide vertical lift have vertical take-off and landing capability.
<b>Civil Aviation Authority (CAA)</b>	Any authority that maintains legal jurisdiction over the airspace above any country. Aircraft operating within a country or flying over a country (overflight clearance) must make arrangements through CAAs, registering flight plans and obtaining proper clearances.
<b>International Aviation and Transportation Administration (IATA)</b>	An international governing body that sets safety regulations on commercial flight. / aircraft commercially operating between two different countries that mutually recognize IATA standards is legally obliged to follow IATA regulations.
<b>International Civil Aviation Organisation (ICAO)</b>	A specialised UN agency that supports the development of mutually recognised civil aviation standards among UN member states, including air safety regulations.

<b>Tech Stop</b>	Used to describe a situation when an aircraft must be on the ground for technical reasons. Usually tech stops refer to refuelling, but they can also be for unscheduled maintenance. Sometimes referred to as "going technical."
<b>Domicile</b>	Where the "permanent" home of the aircraft is, usually where the aircraft is original licensed, and near the owner and operator. Domicile location are also frequently where aircraft receive routine maintenance as well, but not always.
<b>Repositioning</b>	Moving an aircraft from one location to another location in anticipation of another need.
<b>Ground Support Equipment (GSE)</b>	Any equipment involving the offloading or moving of cargo around an airport or air strip, in lead up to loading or offloading cargo and people. GSE also includes catering, refuelling and power supply units. Ground handling crews can be employees of governments, or sub contracted service providers.
<b>Airside</b>	Any part of an airport beyond a secure checkpoint usually associated with loading/offloading, service operations and take off/landing. Airside operations occur within close proximity to working aircraft.
<b>Cube/Weigh Out</b>	The act of reaching the maximum limitations to a specific airframe, either by reaching maximum volume (cube out) or its maximum weight (weigh out).
<b>Flight Hours</b>	Defined as the specified hours aircraft, pilot or crew are allowed to operate for. Physical aircraft may only be able to operate for a maximum number of hours in any week or month period, while pilots and crew can only operate for a maximum number of hours per day/week before mandated "crew rest."
<b>Loading</b>	All the special considerations surrounding aircraft loading, such as loading specific and safety concerns. Loading is overseen by a "Loadmaster" or other trained crew, who will ensure proper distribution of weight and balance of cargo, while also screening prohibited or controlled items.
<b><a href="#">Dangerous Goods (DG)</a></b>	Any cargo that might pose a threat to aircraft while in transit or loading/offloading. universal to all forms of transport, but is especially important to air aviation. Definitive handling and labelling standards for DG are outlined in the IATA <a href="#">Dangerous Goods Regulation (DGR)</a> .
<b>Sling Loading</b>	The act of transporting cargo on the outside of a rotor wing aircraft using a net or crane of some kind, with cargo hanging below the aircraft. Sling loading requires special equipment and specially trained pilot and crew, and can only be used in some ideal circumstances.

## Air Transport Arrangements

The nature and type of the arrangements humanitarian agencies enter into for the movement of cargo by air will be largely informed by the volume of goods, type of goods and shipping/destination points. Most medium sized cargo loads (1-20 full pallets / 30 cubic meters) shipped internationally will generally not require a specialised flight, while a high volume of cargo (500+ full pallets / 700 cubic meters) might require obtaining a full plane. Conversely, extended, routine operation inside the borders of a country no matter how small might require long term leasing of an aircraft. For a general overview of airframe size relative to cargo capacity, reference the [air cargo capacity table](#).

In almost all situations, different arrangements for air cargo transport will need to be arranged

by forwarders, brokers, or other third-parties who have the ability to connect requestors to various available options. Regular movement of small cargo can be done through a typical freight forwarder, while specialised charters or leases may be done through specialised brokerages. Agencies acquiring these arrangements will need to go through their typical procurement process.

Typical air transport arrangements can look like:

**Regular scheduled** – Air carriers around the world develop regular routes between high volume or common destinations. Cargo travelling on regularly scheduled movement is similar to buying a seat on a regular passenger plane – it's easy to identify space and move cargo because the movement is predictable and frequent. Cargo shipped along regularly scheduled routes can be moved as excess cargo in the hold of a commercial passenger plane, or transported using regularly scheduled cargo planes. Often, cargo moved along regularly scheduled routes will be broken up into multiple tranches and re-consolidated on the receiving end, a process that is enabled by the predictability of arriving flights. Regular movement by air is cheaper than organising special flights. Unfortunately, regular scheduled flights will not deviate from their courses, and tend to only serve more developed markets.

**Charters** – Many forwarders and air carrier specialise in organising charter flights – flights specifically dedicated to the movement of one or a very few consignments. Charter flights are often extremely expensive, but have the advantage of being able to depart from a specified origin, arrive at a specified destination, and meet the size and airframe requirements of the proposed air movement. A properly arranged charter might be able to match the size of the aircraft to the requested cargo size saving on total costs, as well as identify special needs such as the overall operating environment or limitations on size of aircraft. Unfortunately, charting aircraft frequently means repositioning an aircraft from another area as the exact airframe may not be domiciled at the desired point of departure. This means that users of charter services usually have to pay for repositioning costs. As charters are basically only single aircraft, shippers run the risk of technical defaults holding up the entire process as well. Factors that influence the decision to charter and the nature of the aircraft chartered:

**Aircraft Leasing** – In situations where long term, well identified needs are in place, organisations may choose to lease aircraft. Aircraft can be leased for months or years at a time, and leased aircraft can be used on an ongoing basis for needs as they evolve. A “Dry Lease” is when an aircraft is made available to an agency without additional support of crew or maintenance, while a “Wet Lease” is a lease type that includes pilots, crew, and aircraft maintenance. Wet leases are more expensive, especially because flight and maintenance crews are paid at a commercial rate and because food and housing is usually part of the contact, but many agencies prefer wet leases due to the fact they take the complexity of aircraft management out of the hands of non-aviation experts.

**Other arrangements** – During times of emergency, air cargo may be transported through a variety ad-hoc or irregular means. This might include cargo movement on military air craft, in personally owned air craft, or agencies offering free space to each other. The process of utilising non-traditional air transport to move cargo can have varied procedures and tolerance thresholds. Irrespective of the movement type, users will have to respect CAA and national import regulations at all times.

## **Unique Components to Air Transport**

Air transport has become so common in the modern world that shippers frequently take key important factors for granted, or overlook them when planning and utilizing aviation for cargo.

Understanding some of these unique needs will help when planning large international shipments, but will also help understanding in-country and response specific aviation needs as well.

## **Weight as a Limiting Factor**

In all aviation, one of the largest factors that impact speed and price is the overall weight of the airframe and its contents. In cargo operations, the take-off weight of an airframe in flight can vary substantially – an airframe fully loaded with heavy cargo easily double the total weight of the same aircraft without cargo. All aircraft have what is known as a “maximum take-off weight” – or the maximum weight at which an aircraft can safely take off and reach the desired altitude and flight path. This weight is calculated as a combination of the physical aircraft, cargo, passengers, and fuel. The maximum take-off weight can also be impacted by outside conditions, such as the wind direction, ambient temperature or the length of a landing strip. Pilots and loadmasters have ultimate discretion for the safety of their aircraft and crew, and will make the final calculations on what is safe and achievable for an aircraft, and what is not.

Based on the aforementioned factors, the acceptable weight of the payload may fluctuate, changing costs and overall delivery schedules. For this reason, light but voluminous cargo might always be able to fill up an entire cargo hold – or “cube out” by reaching the maximum available load through volume – while more dense and bulky cargo might be able to take a relatively small portion of a cargo hold – or “weighing out” by reaching the maximum lift weight. The orientation of a cargo inside of an aircraft is also very important, and loadmasters and crews will need to properly place and balance loads to maximise aircraft safety while taking off, flying and landing.

## **Fuel as a Limiting Factor**

Aircrafts consume relatively large amounts of fuel per kg compared to other transport methods, and unlike other modes of transport, stopping to undergo refuelling is a complicated process. Whereas a boat or vehicle running out of fuel in mid-movement might strand a vehicle or leave it adrift, an aircraft running out of fuel has immediate and tragic consequences. In aviation, fuel calculations are estimated per flight, based on range, altitude, cargo load, wind conditions, and if the airport of arrival has refuelling capabilities. In real terms, there are many factors that might make travel over the same distance consume more or less fuel than it would in a similar route. An increase in the take-off and carriage weight increases fuel used per km, while flying into a prevailing wind-current will also increase fuel consumed per km. Knowing this, crews will increase the fuel in their tanks, which might adversely affect maximum take-off weight. In other words, the cost for kg of cargo might go up, while the total quantity of kg you can ship might go down.

## **Prevailing Conditions as a Limiting Factor**

Aircraft – though highly engineered pieces of equipment – can still be heavily impacted by the physical environment. In addition to factors that can be controlled by the crew and pilots (such as load and maintenance) some external factors that might impact an aircraft’s ability to operate safely are:

- Take-off/landing altitude – the higher altitude a landing strip or airport is, the more hazardous take-off and landing might be. Fixed wing aircraft will need to approach landing strips at faster speed and reach a faster speed to take off, all while requiring a longer

runway to accommodate both. Rotor wing aircraft will need a slightly higher rotational speed to achieve lift at higher altitudes as well.

- Wind – heavy winds can make take-off/landing and flight hazardous. For fixed wing aircraft, a strong tail wind might increase the distance for safe take off, which is why many airports will reverse the landing and take-off directions if the direction of the winds change. A sidewind blows at a perpendicular angle to the direction of movement of an aircraft in flight, takeoff and landing, and can make navigation and take-off/landing dangerous. Any strong prevailing wind can make operating a rotor wing aircraft of any kind dangerous, especially gusts that may tilt rotors during take-off/landing or cause sudden loss of altitude.
- Atmospheric conditions – Dust, fog, and heavy rain can render flight and take-off/landing difficult or impossible, especially in night time settings. Air temperature also plays major factor; excessive outside heat can make taking off difficult, and aircraft may be not be able to take off in extreme heat.

## **Airport Facilities as a Limiting Factor**

Though aircraft may be able to physically fly to a destination, they may not be able to adequately service the cargo needs. Limiting factors might include:

- Lack of refuelling capability on the ground – aircraft on long haul flights may not be able to properly stop and offload if they cannot refuel.
- Lack of ground handling equipment – most commercial aircraft will require some form of specialised MHE to offload and move cargo around. Lack of proper MHE can impede or prevent offloading or loading all together. Some aircraft, especially military aircraft have the capacity to load without MHE, and may have onboard ramps to tail and nose load aircraft by hand.
- Lack of customs capability – not all airports have the ability to clear cargo through customs, limiting movement to domestic flights only.
- Lack of ground service/ground handling – ground crews help load/offload, service and conduct repairs to aircraft. Without ground crews, small technical issues may ground aircraft until proper technicians can arrive. Ground services also conduct de-icing, support catering, and provide other support services that can impact timely departures.
- Lack of storage and holding capacity – airports that lack proper ability to store cargo once offloaded may quickly become unusable for aircraft operations. Cargo building up on the apron space of the tarmac might impede the flow of ground movement and even prevent further cargo from being offloaded.
- Lack of aircraft parking space – an airport may lack the space for multiple aircraft to land, park and offload at the same time. Landing strips or airports limited to one or a small number of aircraft that can park at the same time will need to schedule flights accordingly, impacting delivery schedules
- Lack of communications equipment – immediately after disasters, surface to air communication, radar equipment or even observation towers may be damaged, which impede safe approach, landing and take-off of aircraft.



## Regulations as a Limiting Factor

Local and internationally recognised regulations may impede cargo operations by limiting or preventing aircraft from operating all together. Some of these regulatory factors might include:

- Overflight clearance – aircraft must obtain overflight clearance from relevant in-country CAAs to operate in any country specific airspace. Countries may have bans on specific airlines or aircraft from registered in certain countries. Overflight clearances may also be delayed or rejected based on political or security concerns.
- Landing permits – like overflight, aircraft must obtain permission to land at an airport through both the CAA and airport authorities. Restrictions might include airframe type, origin or intended purpose. Aircraft may also be limited by the already in place schedule.
- Noise restrictions – airports near urban centres may ban certain large body aircraft that have excessively loud engines. Many of the larger high lift capacity cargo aircraft also happen to be very noisy, which might impact what airports cargo can fly out of.
- Maintenance Schedules – many air craft will require annual maintenance that might take them off line for up to a month, depending on the aircraft and the location an aircraft might need to be serviced at. This will impact the availability of leased aircraft for regular activities.
- Flight-hours – both aircraft and the crews have a maximum number of flight hours they can operate at any given time. Aircraft may be restricted to the number of hours they can fly in a week or month, while crew – and especially pilots – are restricted to the number of hours they can operate in any given 24 hour period, accompanied by what is called mandatory “crew rest” hours.
- Pilot Rating – in addition to being fully licensed to operate an aircraft, pilots also must be rated for key airports or conditions. In some contexts, pilots may need to undergo additional training or simulation time to fully reach this rating, possibly impacting ad-hoc delivery of emergency goods.

## Aircraft Registration

Aircraft operating in any domestic airspace, or above any controlled territory of a country should be legally registered to operate. The registration process varies from country to

country, and there are different types of registration depending on the intended use of the aircraft, such as military or non-international. As a general rule, most countries:

- Won't allow an aircraft to be registered twice, even in another country.
- Require that registration numbers (sometimes referred to as a tail numbers) be printed on a fireproof plate on the fuselage.
- Require aircraft be registered in the country in which the carrier is based or domiciled.

If an aircraft will operate internationally – fly between/over two or more different sovereign countries – it must also have declared an intent to operate internationally through its local CAA and comply with international standards including IATA and ICAO requirements for marking, communications equipment, and safety standards. If an aircraft operates internationally, it is considered a “flag-carrying” vessel of its originally country of registration, however while in the airspace of another country it must comply with all local laws and regulations. Without declarations of intent to operate internationally and without fully compliance with international standards, aircraft may not be allowed to register a flight plan, land or load/offload passengers or cargo, or even receive technical assistance when operating in a country outside of where the aircraft is registered.

Example Tail Numbers:

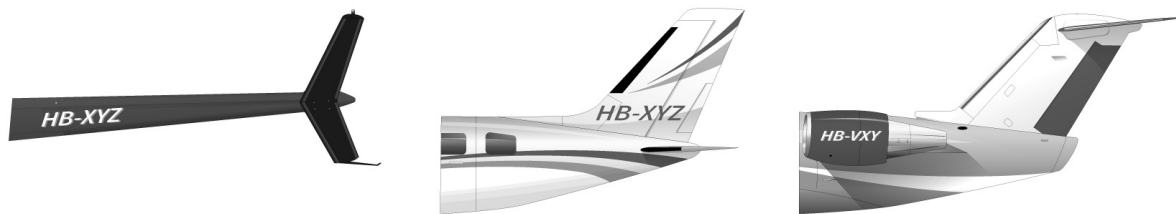

## Airport / Airfield Operations

Large commercial airports can be busy places, and access is usually highly restrictive and controlled. Humanitarian actors won't usually get direct access to airside operations of a major airport, but from time to time humanitarian personnel will need to gain access to and facilitate cargo alongside the aircraft. In less developed or more rural field settings, it's quite common that humanitarian actors will need to operate on or around landing strips.

### Commercial Airports:

Activities in and around commercial airports tend to be highly regulated for a variety of reasons; aviation equipment is expensive and highly sensitive, customs operations may necessitate access control, and airports are considered key infrastructure choke points.

Commercial airports may have a relatively high volume of throughput, with aircraft taking off, landing and exchanging goods and passengers frequently. The immediate airspace surrounding airports is highly restricted, and only aircraft who have registered a flight plan or communicated well in advance are typically allowed to land. Air-traffic is controlled through a control tower, that typically has line-of-sight, radar and radio communication capabilities for arriving and departing aircraft. Aircraft follow a flight path on approach or take off, meaning there is a very specific route aircraft can travel long while moving around the airspace above an airport. Flight paths reduce the chances of mid-air collisions and near misses, and even helicopters and other vertical take-off aircraft are expected to follow the flight path around airports.



Controlling the flow of aircraft is vital for a functioning airport. There is a limited number of landing strips, and a limited amount of space on the ground for planes to taxi and park. Too many aircraft taking off, landing or operating on the ground can cause accidents and serious damage. It's difficult for airplanes to manoeuvre quickly while on the ground, and planes landing or taking off may collide with planes moving around a runway. Additionally, too many aircraft on the ground may lead to planes touching wings or colliding with each other, which can damage and ground an aircraft.

Large airports should have the ability to service large aircraft and manage cargo operations. Large commercial or long haul aircraft typically won't carry enough fuel for a return journey and will need refuelling upon arrival. Many large commercial aircraft also frequently require an external electrical power source to start the engine ignition process, usually referred to as a Ground Power Unit (GPU). Without fuel or a GPU, many aircraft simply cannot land in an airport even if they are physically capable of doing so - there would be no way for them to safely start their engine or take off again.

**Ground Power Unit (GPU)**



**Airside Refueling Truck**



Large commercial airports will also have other services available for aircraft and crews. Service technicians and spare equipment may be kept on site for commonly used aircraft, especially if the airport is a hub for a commercial airline with a pre defined fleet. Commercial airports are also likely to have rapid response emergency crews, including emergency medical technicians and fire suppression systems such as fire trucks.

In rapid onset emergencies, the break down in communications equipment or airport amenities can lead to airports ceasing to function for days or weeks at a time, which can severely impact response activities.

Cargo operations in commercial airports are heavily aided by ground handling teams and specialised MHE. Many large wide-bodied commercial aircraft are specifically engineered for efficient high altitude long-haul flights; this unfortunately results in aircraft bodies that are not optimised for loading or unloading. The majority of aircraft used for commercial cargo will have significant ground clearance, requiring what is called a high loader / k-loader / scissor lift, container pallet transporters, dolly's or other specialised equipment.

Example Ground Handling Equipment:

**High-Loader / K-Loader / Scissor Lift** -Used to lift pre-made ULDs and pallets directly to the side of large commercial aircraft. High-loaders are adjustable and can move under their own power. The flat deck of a high loader also has powered rollers that can mechanically slide cargo on to the aircraft through the appropriate opening.



**ULD / Aircraft Pallet Mover** -A specialised vehicle designed to move around the oversized ULDs and aircraft pallets on a tarmac or landing strips. The pallet movers have rollers and other equipment to quickly get cargo items on and off, and work in conjuncture with high-lights and other MHE.



**Belt Loader** - An automated conveyor belt with adjustable height that can convey smaller items to the door of any sized airframe. Belt loaders are usually used for luggage, loose packages or small specially items. Belt loaders may also be used for aircraft that is too small to accept a high-lift.



**ULD / Airplane Pallet Pull Cart** -A pull cart designed to carry ULDs and pre-built airplane pallets. The pull carts are not powered by themselves, and must be pulled or pushed across the tarmac. Rollers assist offloading and loading, but cargo must be physically pushed as there is

no mechanically driven process.



Access to the planes may be through relatively small cargo doors on the side or nose of the aircraft, though tail loading aircraft do operate out of commercial airports as well.



K-loader - Cargo requiring high lift loading alongside an aircraft

Once cargo is on the ground, it is moved around and handled by ground handling agents. If the airport has customs capabilities, there will typically be an adjacent bonded storage facility of some kind where cargo is held until it is cleared. The overall movement of cargo around an airport is highly controlled and usually quite efficient. As such, cargo operations are usually only carried out by contracted or subcontracted teams of professionals.

### **Airfields / Landing Strips:**

In humanitarian contexts, operating small to medium sized aircraft inside specifically to aid the movement of cargo within of the area of response are quite common. In some instances, small chartered craft can be used for one or a few individual flights, while other contexts there can be specifically planned "hub and spoke" models for humanitarian air cargo operations, with smaller aircraft delivering throughout a responses from a larger central airport. In the majority of contexts, smaller air fields are entirely for domestic use. Customs is usually never going to be processed at the remote airfield or landing strip level - usually cargo offloading points in remote locations are the final leg of an in-country hub and spoke distribution system.

Remote field locations and small airfields probably will not have most, if any, of the amenities of a larger commercial airport. Aircraft operating around smaller field landing strips should have considered the following:

- Adequate surface to ground communications equipment on a usable operating band accessible by both the pilot and ground actors.
- Fuel for the return flight.
- An onboard power supply to start engines.
- Basic equipment for repairs.

Ideally, there will be an identified safety officer or team on the ground, who can ensure that the landing strip is free of debris, animals or people, and who should have the capacity to coordinate with any potential incoming aircraft regarding scheduling and landing conditions. Some landing strips may be impacted by bad weather, making safe taxi and takeoff impossible. At all times, aircraft operating in or around remote landing strips must still obey local CAA regulations, and may even need to coordinate with local military and local community leaders to avoid incidents.

Aircraft will have to be appropriate for the operating conditions, and the underdeveloped nature of many landing strips in humanitarian contexts tends to limit the size of most cargo aircraft. Aircraft will need to be able to safely take off and reach altitude based on the length of the landing strip, the anticipated cargo weight, and the outside weather conditions. Rotor wing aircraft will need to account for any potential negative side effects of their rotor down-draft while on approach, avoiding damaging homes or property, injuring humans or animals with debris, or making the landing site dangerous for other aircraft.

Cargo operations in small airfields or landing strips should match the available capacity on the ground. Most cargo at remote landing strips will need to be loose loaded and offloaded by hand. The aircraft themselves will need to be capable of being safely accessed and loaded/offloaded by relatively unskilled labour, usually with ramps or low side clearance.

Cargo offloaded using ramps - can be done easily by hand

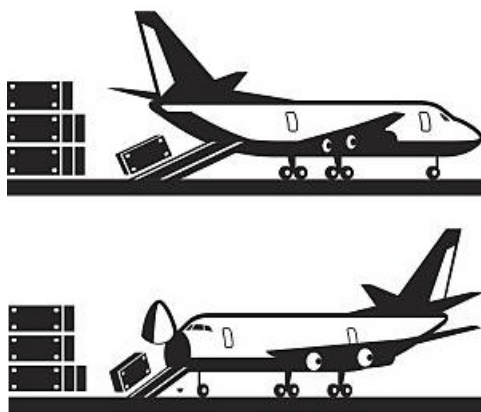

Cargo requiring special ground equipment and MHE to offload

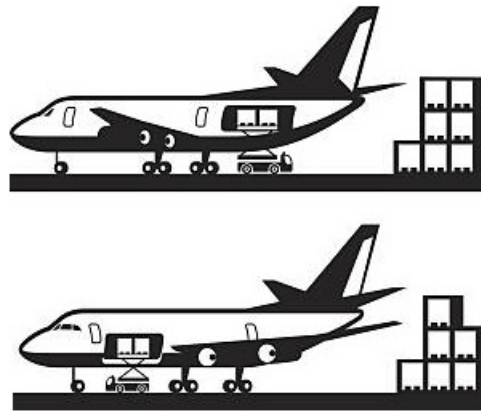

Physical access to landing strips may be quite unrestricted, meaning persons and vehicles may be able to operate right next to the aircraft. Any vehicles brought to the landing strip to facilitate cargo movement should be careful not to get near or damage the aircraft; an aircraft grounded in a remote location likely will not have access to special parts or sophisticated repairs for some time, effectively putting the aircraft out of service.

## Personal Safety Around Aircraft

Operating on landing strips or airports can be extremely dangerous. Aircraft have extremely powerful propellers or jets, while vehicles and MHE may move chaotically around busy tarmacs. The necessity to utilize certain types of personal protective equipment (PPE) depends on the nature and size of the operation. Common PPE used around cargo aircraft might include:

- High-visibility / reflective vests
- Work gloves and close toed shoes

- Ear and eye protection

Reflective vests should always be used in airside operations where motorized ground handling equipment is used, or where multiple aircraft may be taking off/landing/taxing simultaneously. Aircraft and ground handling equipment often have very poor visibility, and their size and weight can easily harm or kill humans.

Aircraft propulsion can also be extremely loud, and operating within any close proximity to an aircraft with jets or propellers turned on can easily permanently damage hearing. Hearing damage may be acute and rapid, or it may accumulate over time. Ground crew operating around active aircraft at any time should wear proper ear protection at all times. Any person travelling in a helicopter for any period of time should also always wear ear protection. Some older fixed wing aircraft also may require passengers to wear ear protection.

Aircraft have powerful propulsion systems to keep them in flight, and these propulsion systems are extremely dangerous to be around when the vehicle is not in flight. When moving around a landing strip or airport tarmac, **never under any circumstances** approach a jet turbine, helicopter blade or propeller while it is in motion, unless it is under the direct supervision of qualified ground safety personnel. Turbines, blades and propellers should also be avoided if the aircraft engine is running or the operating status of the aircraft is unknown.

When operating around an airfield, never assume freedom of movement. Airfields and airports are often highly restricted environments, and air and ground handling crews won't necessarily expect the presence unauthorized persons. Before operating in any space where aircraft land, take off, or are repaired, refueled or loaded/offloaded, consult with airport authorities and your local security focal point.

## **Sending Goods by Air**

### **Air Transport Documentation**

The overall requirements for and types of documentation used for air transport depend on the nature of the air transport. The normal documentation requirements for most shipments ([waybill](#), [packing list](#), [proforma](#), [etc](#)) applies to all shipments, including air shipments. There are documents specific to air shipping however. These might include:

**Airway Bills (AWB)** - By far the most common and important document related to airfreight. AWBs are regulated by IATA, and have a standard format for ease of reading and reference. It should be noted that AWBs are only legally required for international transport, however domestic CAA and even non officially regulated air carriers can and do request the use of AWBs. The AWB is the carrier's receipt by air, evidence of the contract of carriage and is usually non-negotiable. It is made out to a named consignee who is the only party to whom the carrier can deliver. Many carriers even make it easy to track and trace cargo in real time using AWB numbers on their website. Through its standardised layout, AWBs will denote:

- Shipper name and contact details
- Consignee/Notify party name and contact details
- Special handling information
- Cargo description, including item description and total chargeable weight
- Customs value

The above information should match the information coming on other shipper generated shipping documents. In the top right corner of every official AWB, there will be an AWB

number, which is unique to that one AWB. The AWB number is always eleven digits; the first three are the IATA designated airline prefix, while the last seven digits are the unique serial number. Many airlines make AWB numbers easy to trace online.

Original, airline generated AWBs are generally the only acceptable AWBs that customs authorities will recognise. The original paper copy will go with the consignment, but scanned copies are usually acceptable for customs purposes. The AWB generated by the airline is typically referred to as the "Master" AWB, or sometimes MAWB.

Shipper's Name and Address		Shipper's account Number		Not negotiable <b>Air Waybill</b>			
				issued by			
Consignee's Name and Address		Consignee's account Number		Copies 1, 2 and 3 of this Air Waybill are originals and have the same validity			
				It is agreed that the goods described herein are accepted in apparent good order and condition (except as noted) for carriage SUBJECT TO THE CONDITIONS OF CONTRACT ON THE REVERSE HEREOF. ALL GOODS MAY BE CARRIED BY ANY OTHER MEANS INCLUDING ROAD OR ANY OTHER CARRIER UNLESS SPECIFIC CONTRARY INSTRUCTIONS ARE GIVEN HEREOF BY THE SHIPPER, AND SHIPPER AGREES THAT THE SHIPMENT MAY BE CARRIED VIA INTERMEDIATE STOPPING PLACES WHICH THE CARRIER DEEMS APPROPRIATE. THE SHIPPER'S ATTENTION IS DRAWN TO THE NOTICE CONCERNING CARRIER'S LIMITATION OF LIABILITY. Shipper may increase such limitation of liability by declaring a higher value for carriage and paying a supplemental charge if required.			
Issuing Carrier's Agent Name and City		Accounting Information					
Agent's IATA Code		Account No.					
Airport of Departure (Addr. of first Carrier) and requested Routing		Reference Number		Optional Shipping Information			
to	By first Carrier	Routing and Destination	to	by	to		
				Currency	Declared Value for Carriage		
				WT/VOL	Declared Value for Customs		
				Other			
				AMOUNT			
Airport of Destination		Flight/Date	Flight/Date	Amount of Insurance	INSURANCE - If carrier offers insurance, and such insurance is requested in accordance with the conditions thereof, indicate amount to be insured in figures in box marked 'amount of insurance'		
Handling Information							
		SC					
No. of Pieces RCP	Gross Weight	kg	Rate Class	Chargeable Weight	Rate	Total	Nature and Quantity of Goods (incl. Dimensions or Volume)
			Commodity Item No.		Charge		
Prepaid		Weight Charge	Collect	Other Charges			
		Valuation Charge					
		Tax					
		Total other Charges Due Agent					
		Total other Charges Due Carrier					
Total prepaid		Total collect	Signature of Shipper or his Agent				
Currency Conversion Rates		cc charges in Dest. Currency	Executed on (Date) at (Place) Signature of issuing Carrier or its Agent				
For Carrier's Use only at Destination		Charges at Destination	Total collect Charges				

**House AWB** - A "House" AWB - sometimes referred to as a HAWB - is generated by a forwarder or broker and provided to a client upon request. HAWBs generally have all the same

information as a regular AWB, but are not necessarily signed or have the same tracking information as the MAWB. Customs authorities generally do not recognise HAWBs as an official document for customs procedures as there may be some difference between the HAWB and the MAWB. HAWB may still be useful for internal tracking purposes, however.

**Non-Standard Waybills** – In emergency settings, especially when in-country movement is required via air, the AWB may not be applicable or available. Cargo moved via unconventional air movement will generally always require some form of documentation, however this may look like a stand-alone packing list, self-made cargo manifest (similar to a packing list), or in the case of movement on military assets, a standard form internal to that specific military.

**Shippers Declaration of Hazardous Goods (HazDec)** – Much like AWBs, HazDecs are predefined by IATA, and are essential to the shipping process. HazDecs contain relevant information on any and all DG items for loadmasters and pilots. Any airline following IATA regulations will not accept a completed HazDec unless it was filled out and signed by someone who is fully certified in DG handling through an IATA accredited program. Failure to comply with proper completion of a HazDec, or incidents that may occur from incorrectly documented DG can result in fines, court action and jail time. Please consult the [Dangerous Goods section to this guide](#) for more detailed information.

SHIPPER'S DECLARATION FOR DANGEROUS GOODS



Shipper		Air Waybill No.								
		Page of Pages								
		Shipper's Reference No. (optional)								
Consignee										
Two completed and signed copies of this Declaration must be handed to the operator.		<b>WARNING</b>								
<p><b>TRANSPORT DETAILS</b></p> <p>This shipment is within the limitations prescribed for:</p> <p>(delete non-applicable)</p> <table border="1"> <tr> <td>PASSENGER AND CARGO AIRCRAFT</td> <td>CARGO AIRCRAFT ONLY</td> </tr> </table> <p>Airport of Departure (optional):</p> <p>Airport of Destination (optional):</p>		PASSENGER AND CARGO AIRCRAFT	CARGO AIRCRAFT ONLY	<p>Failure to comply in all respects with the applicable Dangerous Goods Regulations may be in breach of the applicable law, subject to legal penalties.</p> <p>Shipment type: (delete non-applicable)</p> <table border="1"> <tr> <td>NON-RADIOACTIVE</td> <td>RADIOACTIVE</td> </tr> </table>					NON-RADIOACTIVE	RADIOACTIVE
PASSENGER AND CARGO AIRCRAFT	CARGO AIRCRAFT ONLY									
NON-RADIOACTIVE	RADIOACTIVE									
<b>NATURE AND QUANTITY OF DANGEROUS GOODS</b>										
<b>Dangerous Goods Identification</b>										
UN or ID No.	Proper Shipping Name	Class or Division (subsidiary hazard)	Packing Group	Quantity and Type of Packing	Packing Inst.	Authorization				
Additional Handling Information										
I hereby declare that the contents of this consignment are fully and accurately described above by the proper shipping name, and are classified, packaged, marked and labelled/placarded, and are in all respects in proper condition for transport according to applicable international and national governmental regulations. I declare that all of the applicable air transport requirements have been met.				Name of Signatory						
				Date						
				Signature (See warning above)						

## Chargeable Weight

When procuring air transport services, planners must contend with what is called "chargeable weight". As a general rule, airlines charge customers per the gross weight of their cargo. Due to the nature of air travel, an increase in weight generally means an increase in fuel, which is an increase in cost. However, some shipments by their nature are extremely light even though they may take up a large volume. Even though light cargo may take up less fuel, airlines must still charge some basic minimum to recover their operating costs as charting per weight would actually lose them money.



To address income loss to non dense cargo, air operators may speak in terms of "volumetric weight" or "cubic weight." Volumetric weight is a method of determining how to evaluate the relative costs of transporting items based on their volumes. Volumetric weight can be calculated using the following equations:

**Metric**

$$(L \text{ (cm)} \times W \text{ (cm)} \times H \text{ (cm)}) / 6,000 = \text{Volumetric Weight (KG)}$$

**Imperial**

$$(L \text{ (in)} \times W \text{ (in)} \times H \text{ (in)}) / 166 = \text{Volumetric Weight (LB)}$$

**Imperial to Metric**

$$(L \text{ (in)} \times W \text{ (in)} \times H \text{ (in)}) / 366 = \text{Volumetric Weight (KG)}$$

Chargeable weight then refers to the "relative" weight an airline will bill customers at. As a general rule, the transporter will quote customers whichever the greater cost between the two weight values is - the actual gross weight of the cargo or the volumetric weight of the cargo. The airline will be the ultimate party determining how to charge customers, but users of air service should pay close attention to the resulting "chargeable weight" contained on their AWBs. There may be situations where the chargeable weight is significantly higher than their gross weight, which can impact budget and planning.

No. Of Pieces RCP	Gross Weight	kg lb	Rate Class	Commodity Item No.	Chargeable Weight	Rate	Charge	Total
1	460.0	K	Q		460.0			As Agreed

## Movement Timing

In the world of aviation, timing is an enormous factor. Aircraft operating out of commercial airports must adhere to strict schedules and time tables.

- Regularly scheduled air craft typically have pre-defined routing that means they will land and take off at specific intervals that will not change much.
- Charter aircraft are frequently being bid upon by multiple parties, and unless a contract is signed they cannot commit for long periods of time.
- All aircraft are subject to the time tables of the airport they operate in. Large commercial airports might limit the amount of time aircraft can spend on the ground before accruing additional charges. Aircraft will typically only be allotted a limited time in specific parking spots as well.

When arranging to ship cargo by air, parties should be prepared well in advance and have all cargo ready at exactly the time specified by the forwarder or the air operator. A failure to deliver cargo on time could result in additional charges, or losing space on the aircraft all together.

## **Local Aircraft Contracting**

In austere operating environments, individual response agencies may require the use of ad-hoc cargo movement using local air operators. Identifying and understanding the proper aircraft or proper service provider can be extremely challenging, especially at local levels operating with limited time and budgets.

Locally operated aircraft in emergency or conflict settings pose unique and enhanced risks to parties who may wish to contract the service:

- Local/small aircraft may not be fully registered to operate in the context of operation.
- Local operators may have insufficient safety standards, or a known history of safety and security incidents humanitarian agencies may not know.
- In conflict settings, local air operators may be involved with transportation of weapons or supplies to parties of the conflict, sometimes along the same route humanitarian organisations operate.
- In any context, local operators may be involved with smuggling, human rights violations, or other illegal or unethical activities.

As a general rule, humanitarian agencies should not charter local aircraft directly with owners of aircraft. Instead, small scale or local charter aircraft should still be solicited through a reputable and known freight forwarder or brokerage service. Though going through a third-party may add some additional costs, forwarders and brokers have access to information or tools that enable them to screen for inappropriate or unethical transporters. The contracted payment terms and arbitration processes will also likely be more transparent and well defined when going through a reputable third-party.

In the event a third-party forwarder or brokerage is not available or not able to sufficiently fulfil the charter needs, and a humanitarian agency still wishes to solicit local air transport, there are a few steps to be considered by contracting agencies:

- Obtain aircraft registration/tail number, and names of pilot and crew. Though a forwarder may not be able to contract with the party, they may still be able to do a due diligence check.
- Ask other agencies who used the service in the past, as well as consult with local UN offices who may track aircraft (ICAO, UN agencies contracting air assets in country, etc).
- If possible, contact local Civil Aviation Authorities to both check registration and obtain information on safety history.
- Search for the registration/tail number online to see if the aircraft has been flagged for any reason.
- Ensure the air operator understands the route, locations, and cargo (type, dimensions).
- Never sign a contract unless it has been reviewed by both a lawyer locally, and by a designated legal focal point in headquarters.
- Payment terms should indicate payment is only due on successful delivery of cargo – never accept terms that include payment even if aircraft is unable to perform its contracted duties for whatever reason.

## **Cargo Configuration for Air Shipping**

### **Aircraft Loading and Stowage**

Cargo shipped via air tends to require more attention to details. Unlike the inside of a standard

shipping container or regular box truck, the inside of aircraft tends to be irregularly shaped. Fixed wing aircraft – especially fixed wing aircraft that operate at high altitude – will have curved cylindrical interiors, while larger aircraft may have multiple decks of varying heights. Additionally, the width and height of interior cargo holds and aircraft doors is different for virtually every aircraft. Frequently, more than one aircraft will be used for multiple legs of a transport route, meaning pallets can be broken down and cargo reloaded multiple times to match the different types of aircraft. This tends to lead to cargo being broken down and re-consolidated extensively throughout the transport process.

While loading and storing cargo onto an aircraft, there are some specific physical limitations to what and how items can be loaded:

**Cargo Hold** - The cargo hold - or sometimes just referred to as a "hold" - is any space on an aircraft where cargo is stored and transported, including any of compartments on an aircraft. Holds of each aircraft have specific dimensions, including height, depth, width, and shaped curvature of the airframe itself. These dimensions will limit what and how objects are loaded.

**Payload** - the maximum carrying capacity of an aircraft, usually expressed in weight. Max payloads may change for a single aircraft based on distance and operating conditions.

**Door Dimensions** - Doors are any/all points where cargo can enter or leave an aircraft. Door dimensions have maximum sizes specific to the aircraft, and ultimately limit what can be loaded. Even the hold is large enough to store a certain object, it may not be able to fit through the doors of the aircraft. Planners and loaders should understand this before trying to load an aircraft.

**Load Balance** - Cargo loaded onto a plane must be properly balanced. A balanced cargo load maximises safety and energy efficiency, while an unbalanced load can lead to serious safety risks.

At any time, when cargo is being loaded onto an aircraft, there will be an appointed **loadmaster**. A loadmaster may be a regular crew member, the pilot, or in the case of large commercial operations, specially certified persons who work only in cargo loading. In any situation, the loadmaster is the person ultimately responsible for determining how and what gets loaded onto a plane

Cargo can be loaded into specially defined sections of an aircraft including:

- **Deck Cargo** – cargo loaded onto the main deck/body of an aircraft.
- **Belly Load** – cargo loaded onto the under deck/belly of an aircraft.
- **Nose Load** – cargo loaded into the front compartment of an aircraft.
- **Tail Load** – cargo loaded into the rear compartment/area past the rear wheel base of an aircraft.
- **Sling Load** – cargo carried below of a rotor wing aircraft using special netting, secured harnesses, and ropes.

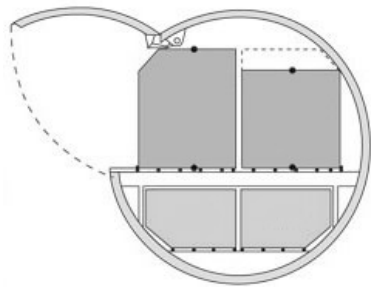

Side loaded cargo hold

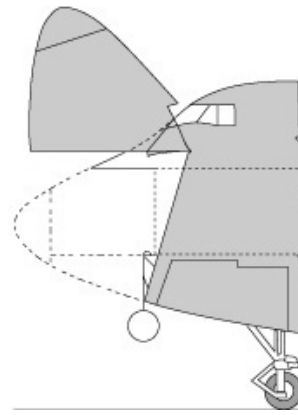

Nose loaded cargo hold

---

To accommodate the variance in the size needs for different airframes, cargo shipped via air tends to be “loose-loaded,” being loaded at the lowest handling unit (carton, sack, etc), so that handling crews can maximise space and shape cargo builds to fit the interior of the available cargo space. Oversized cargo, or pre-made pallets that don’t fit the specific dimensions of the airframe in question will either not be loaded, or will need to be broken down into smaller units for loading.

Example upper deck of a cargo plane:

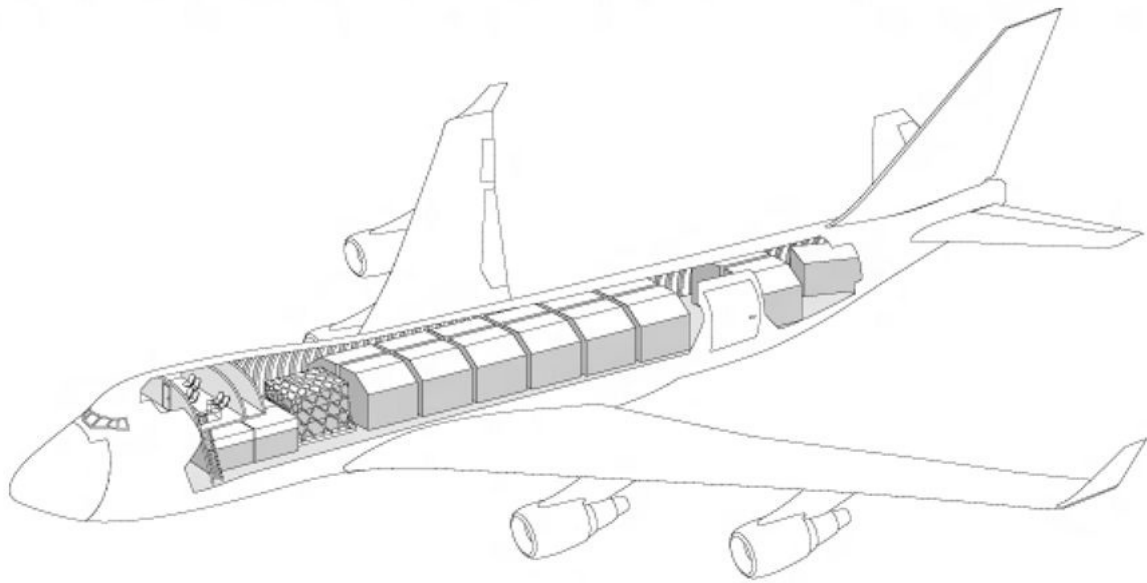

Cargo transported via rotor wing (helicopter) will follow the same general ideas, including limited size and shape of doors and cargo holds, and a comparably smaller maximum take off weights. Helicopters do have one advantage that fixed wing aircraft do not - the ability to transport bulky cargo outside of the aircraft using a sling load. Sling loading is relatively uncommon, and requires specialized equipment, a helicopter with the appropriate capabilities, and requires special pilot training.

Example cargo sling load in action.

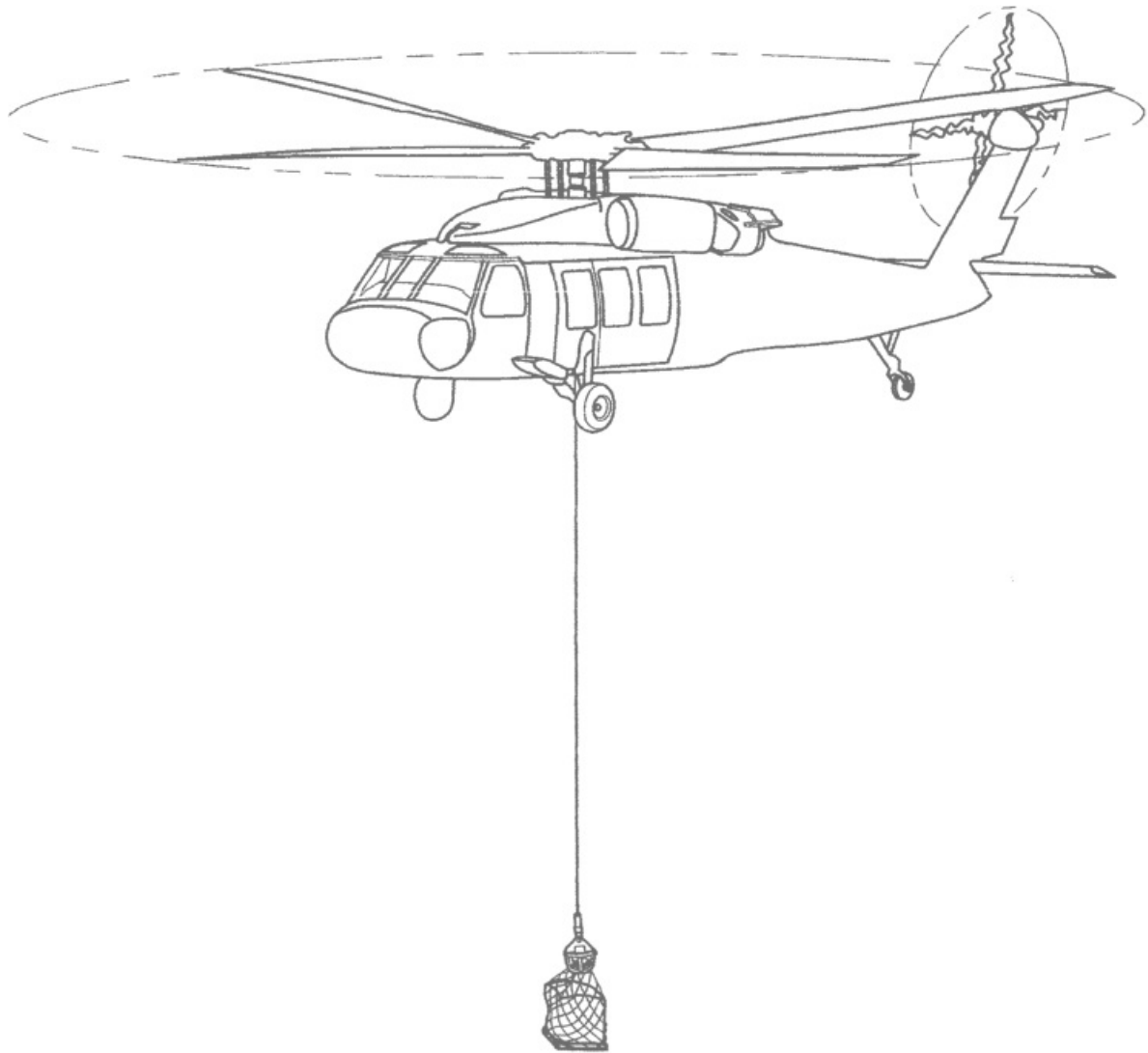

**Unit Load Devices** - Many aircraft will utilise what are known as "Unit Load Devices," (ULD) or pre-made containers that facilitate the easy transport of cargo via air. ULDs are sometimes referred to by the term "Build Up Pallets" or BUPs, however ULD is a more accurate term as many ULDs are not actually pallets, but rather custom designed frames of irregular shapes.

Each airframe has its own specific dimensions of UDL which are used internally by the air carriers and won't be the responsibility of the shipping party to obtain or manage. UDLs require the assistance of MHE or other vehicles to move and load, and are usually managed out of larger professional airport with trained ground crew. Understanding UDLs can help transport planning for shippers.

Some aircraft will load cargo on a type of UDL called an "airplane pallet" - the pallets thin sheets of metal that can be easily moved on rollers, and have much more storage surface than warehouse pallets. Airplane pallets come in a variety of sizes, and are usually purpose built for one or a few aircraft types. Cargo will be loaded loose on the pallet pre-shaped to match the interior of the specific aircraft in question, and will be covered in cargo netting. Airplane pallets and cargo netting can be very expensive, and should be treated as any other expensive equipment.

Example airplane pallet and netting:

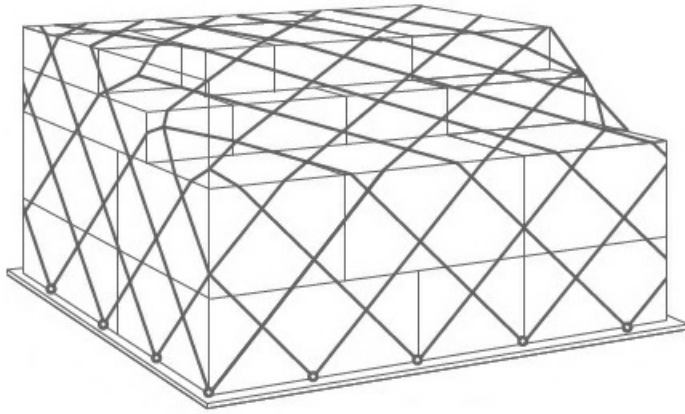

Larger and mixed-use aircraft will often use a form of UDL called a “contoured container.” Contour containers are solid containers with one or more rigid sides that are pre-shaped to match specific compartments inside of an aircraft. The containers are made of extremely thin metal, and are designed to take the guess work out of space planning. There are a variety of contour containers, including partially open containers, refrigerated containers, etc. The use of these specific variations will be decided by the airline and the load master based on the needs of the shipper.

Example contoured container:

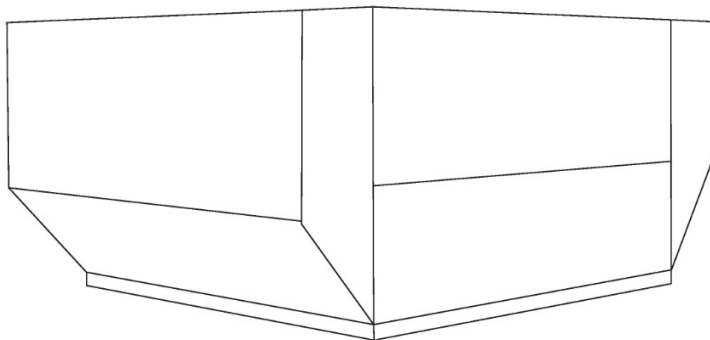

Many ULDs are custom designed for specific purposes, including transporting of refrigerated items or handling livestock. Any form of ULD usually requires specialised handling equipment, and won't be loaded or moved without a trained professional knowledgeable about the cargo, the aircraft and the ULD handling requirements.

**Hand Loading** – Aircraft used in smaller or irregular flights are often loose loaded by hand. This entails loaders and crew manually loading items into a cargo hold at the handling unit level, stacking and stuffing where ever space is available, and where ever is safe or appropriate. Aircraft used in humanitarian operations at the domestic level frequently use hand loading due to lack of equipment and aircraft type. Hand loading aircraft has limitations, including requiring additional time to complete and being less secure than netted cargo, but is useful insofar as it can be done in almost any environment and under almost any condition.









Regardless of ULD or hand loading method, each cargo hold maximum allowable weight may fluctuate from the published weight based on the weight of items loaded into other cargo holds. The Loadmaster should communicate payload limitations in advance and will control cargo at the point of loading.

## **Dangerous Goods (DG)**















Dangerous Goods (DG) has special packaging and labelling requirements. IATA [continually publishes an updated guide](#) for DG packaging and labelling for air transport. Dangerous goods of different classification will need to be labelled with the appropriate and corresponding label. Additionally, IATA and other safety guidelines may stipulate the maximum size and quantities of certain DG items that can be transported, and will stipulate any required “overpacking,” or an additional layer of packaging over the handling unit packaging. Packaging and labelling standards for cargo should be overseen by persons who are properly certified and accredited through an IATA approved DG certification program. Please consult the [Dangerous Goods section to this guide](#) for more detailed information.

## Aircraft Specifications for Cargo















The below table contains a *non-exhaustive* list of cargo aircraft commonly used for domestic and international cargo movements. The weights and volumes in this table are only indicative of aircraft capacities under ideal conditions. [Real world conditions and limitations](#) will determine actual transport capacities. Please consult with air operators at the time of contract cargo service. A downloadable copy of this can [be found here](#).



Aircraft	Payload (kg)	Volume (m3)	Usable Hold Size (cm)			Door Size (cm)	
			L	W	H	W	H
 Piper PA-31	600	4	386	103	130	65	113
 Kingair 90	1,000	4	368	127	120	160	109
 Metro II	1,250	18	900	110	27	135	130
 Cessna 406	1,400	7	340	129	130	120	120
 Embraer Bandeirante	1,500	14	590	133	144	180	143
 Bell UH-1 Iroquois	1,760	6	262	233	132	188	122
 Dornier 228	1,950	18	635	127	147	133	138
 Metro III	2,000	12	918	115	105	135	130



Aircraft	Payload (kg)	Volume (m3)	Usable Hold Size (cm)			Door Size (cm)	
			L	W	H	W	H
	<b>2,041</b>	<b>10</b>	<b>609</b>	<b>152</b>	<b>140</b>	<b>187</b>	<b>140</b>
	<b>3,200</b>	<b>42</b>	<b>840</b>	<b>176</b>	<b>180</b>	<b>141</b>	<b>167</b>
	<b>3,850</b>	<b>36</b>	<b>1,110</b>	<b>162</b>	<b>175</b>	<b>135</b>	<b>130</b>
	<b>4,000</b>	<b>23</b>	<b>534</b>	<b>230</b>	<b>180</b>	<b>234</b>	<b>182</b>
	<b>5,000</b>	<b>7</b>	<b>452</b>	<b>130</b>	<b>132</b>	<b>120</b>	<b>120</b>
	<b>5,500</b>	<b>30</b>	<b>1,110</b>	<b>220</b>	<b>160</b>	<b>230</b>	<b>167</b>
	<b>5,700</b>	<b>51</b>	<b>1,385</b>	<b>226</b>	<b>175</b>	<b>127</b>	<b>153</b>
	<b>6,000</b>	<b>55</b>	<b>1,055</b>	<b>190</b>	<b>180</b>	<b>267</b>	<b>172</b>
	<b>6,000</b>	<b>62</b>	<b>1,524</b>	<b>210</b>	<b>190</b>	<b>232</b>	<b>178</b>
	<b>7,030</b>	<b>67</b>	<b>1,577</b>	<b>236</b>	<b>198</b>	<b>300</b>	<b>180</b>
	<b>8,165</b>	<b>52</b>	<b>957</b>	<b>266</b>	<b>208</b>	<b>250</b>	<b>208</b>
	<b>8,200</b>	<b>78</b>	<b>1,550</b>	<b>200</b>	<b>180</b>	<b>263</b>	<b>172</b>
	<b>8,200</b>	<b>76</b>	<b>1,796</b>	<b>226</b>	<b>175</b>	<b>127</b>	<b>153</b>
	<b>10,000</b>	<b>78</b>	<b>1,780</b>	<b>260</b>	<b>190</b>	<b>333</b>	<b>193</b>
	<b>10,000</b>	<b>52</b>	<b>1,050</b>	<b>215</b>	<b>220</b>	<b>240</b>	<b>227</b>

	Aircraft	Payload (kg)	Volume (m3)	Usable Hold Size (cm)			Door Size (cm)	
				L	W	H	W	H
	<b>McDonnell Douglas DC 9-15F</b>	<b>10,400</b>	<b>91</b>	<b>2,340</b>	<b>274</b>	<b>205</b>	<b>346</b>	<b>206</b>
	<b>Boeing CH-47 Chinook</b>	<b>10,886</b>	<b>42</b>	<b>930</b>	<b>229</b>	<b>198</b>	<b>220</b>	<b>190</b>
	<b>Lockheed L-188 Electra</b>	<b>15,000</b>	<b>91</b>	<b>2,200</b>	<b>274</b>	<b>210</b>	<b>355</b>	<b>198</b>
	<b>Antonov An-12</b>	<b>18,000</b>	<b>85</b>	<b>1,355</b>	<b>280</b>	<b>240</b>	<b>280</b>	<b>240</b>
	<b>Boeing B737-400F</b>	<b>19,237</b>	<b>154</b>	<b>2,440</b>	<b>319</b>	<b>214</b>	<b>340</b>	<b>210</b>
	<b>Boeing B737-300F</b>	<b>19,275</b>	<b>130</b>	<b>2,324</b>	<b>317</b>	<b>214</b>	<b>348</b>	<b>216</b>
	<b>Eurocopter AS-332 Super Puma</b>	<b>20,000</b>	<b>17</b>	<b>681</b>	<b>180</b>	<b>147</b>	<b>130</b>	<b>135</b>
	<b>Mil Mi-26</b>	<b>20,000</b>	<b>110</b>	<b>1,200</b>	<b>320</b>	<b>310</b>	<b>290</b>	<b>320</b>
	<b>Lockheed L-100-30 Hercules</b>	<b>21,000</b>	<b>140</b>	<b>1,609</b>	<b>301</b>	<b>260</b>	<b>301</b>	<b>274</b>
	<b>Boeing B727-200F</b>	<b>24,042</b>	<b>186</b>	<b>2,712</b>	<b>351</b>	<b>213</b>	<b>340</b>	<b>218</b>
	<b>Tupolev Tu 204</b>	<b>28,500</b>	<b>170</b>	<b>3,200</b>	<b>318</b>	<b>210</b>	<b>340</b>	<b>210</b>
	<b>Boeing B757-200F</b>	<b>36,000</b>	<b>238</b>	<b>3,327</b>	<b>353</b>	<b>213</b>	<b>340</b>	<b>218</b>
	<b>Ilyushin IL-62</b>	<b>40,000</b>	<b>230</b>	<b>2,798</b>	<b>317</b>	<b>212</b>	<b>345</b>	<b>200</b>
	<b>Airbus A310-300F</b>	<b>40,500</b>	<b>270</b>	<b>3,300</b>	<b>477</b>	<b>240</b>	<b>318</b>	<b>244</b>
	<b>McDonnell Douglas DC-8 54 55F</b>	<b>41,000</b>	<b>201</b>	<b>3,100</b>	<b>322</b>	<b>218</b>	<b>355</b>	<b>215</b>
	<b>Boeing B767-200F</b>	<b>42,000</b>	<b>367</b>	<b>3,116</b>	<b>442</b>	<b>250</b>	<b>340</b>	<b>244</b>

	Aircraft	Payload (kg)	Volume (m3)	Usable Hold Size (cm)			Door Size (cm)	
				L	W	H	W	H
	<b>McDonnell Douglas DC-8 62F</b>	<b>42,000</b>	<b>220</b>	<b>3,300</b>	<b>322</b>	<b>218</b>	<b>355</b>	<b>215</b>
	<b>Airbus A300 B4F</b>	<b>44,500</b>	<b>300</b>	<b>3,550</b>	<b>477</b>	<b>245</b>	<b>318</b>	<b>244</b>
	<b>McDonnell Douglas DC-8 71 73F</b>	<b>45,000</b>	<b>302</b>	<b>3,900</b>	<b>313</b>	<b>210</b>	<b>350</b>	<b>216</b>
	<b>Airbus A300- A600F</b>	<b>47,000</b>	<b>426</b>	<b>4,070</b>	<b>528</b>	<b>245</b>	<b>358</b>	<b>256</b>
	<b>Ilyushin IL-76T and IL76-TD</b>	<b>48,000</b>	<b>180</b>	<b>1,850</b>	<b>345</b>	<b>325</b>	<b>345</b>	<b>325</b>
	<b>Boeing B767- 300F</b>	<b>54,000</b>	<b>450</b>	<b>3,890</b>	<b>450</b>	<b>250</b>	<b>340</b>	<b>250</b>
	<b>Lockheed L1011 TriStar</b>	<b>55,000</b>	<b>440</b>	<b>3,300</b>	<b>485</b>	<b>274</b>	<b>431</b>	<b>284</b>
	<b>Ilyushin IL-76TF</b>	<b>60,000</b>	<b>400</b>	<b>3,114</b>	<b>345</b>	<b>325</b>	<b>345</b>	<b>325</b>
	<b>McDonnell Douglas DC-10F</b>	<b>65,000</b>	<b>484</b>	<b>3,725</b>	<b>558</b>	<b>234</b>	<b>356</b>	<b>259</b>
	<b>Airbus A330-200F</b>	<b>70,000</b>	<b>475</b>	<b>5,882</b>	<b>528</b>	<b>245</b>	<b>358</b>	<b>256</b>
	<b>Boeing MD 11F</b>	<b>85,000</b>	<b>575</b>	<b>4,400</b>	<b>488</b>	<b>244</b>	<b>350</b>	<b>259</b>
	<b>Ilyushin IL-96- 400T</b>	<b>88,000</b>	<b>580</b>	<b>4,444</b>	<b>571</b>	<b>286</b>	<b>485</b>	<b>287</b>
	<b>Boeing B777-200F</b>	<b>103,000</b>	<b>653</b>	<b>4,412</b>	<b>582</b>	<b>315</b>	<b>372</b>	<b>315</b>
	<b>Boeing B747-200F</b>	<b>111,583</b>	<b>759</b>	<b>4,800</b>	<b>486</b>	<b>304</b>	<b>340</b>	<b>312</b>
	<b>Antonov An-124</b>	<b>120,000</b>	<b>750</b>	<b>3,648</b>	<b>640</b>	<b>440</b>	<b>640</b>	<b>440</b>

Aircraft	Payload (kg)	Volume (m3)	Usable Hold Size (cm)			Door Size (cm)	
			L	W	H	W	H
 Boeing B747-400F	120,200	735	4,800	486	304	340	312
 Boeing B747-8	140,000	857	5,430	486	304	340	312
 Antonov An-225	250,000	1,100	4,535	640	440	640	440

Adapted from [Air Charter Service](#)

Title

Download - Aircraft Cargo Specifications

File



## Sea Transport

Cargo transport by sea is by far the cheapest per kilogram per kilometre moved relative to the other major forms of transport used by other humanitarian agencies, and is convenient for bulky pre-planned consignments. Sea transport is unfortunately also one of the slowest methods of delivering cargo as well. Sea transport will likely not be used to service immediate needs in rapid on-set disasters, and is more appropriate for pre-positioning or to serve post disaster and longer term needs.

## Common Terms in Sea Transport

### Shipping Container

A standard predefined set of containerised shipping units that are used throughout all sea shipments. Shipping containers come in many variations to meet the needs of different shipments. Containers also have unique container numbers that can be tracked, and when in movement containers will be sealed using industry standard container seals. The vast majority of containers come in 20 foot and 40 foot dimensions.

### Full Container Load (FCL)

A volume of cargo from a single party or consignment capable of filling an entire shipping container.

### Less Than Container Load (LCL)

A volume of cargo from a single party or consignment not capable of filling an entire shipping container.

<b>Twenty Equivalent Unit (TEU)</b>	Short hand for identifying a measure of volume equivalent to the container size and identifying slot space on a dock or a ship. One 20-foot container is equal 1 TEU.
<b>Forty Equivalent Unit (FEU)</b>	Short hand for identifying a measure of volume equivalent to the container size and identifying slot space on a dock or a ship. One 40-foot container is equal 1 FEU or 2 TEUs.
<b>Port of Loading (POL)</b>	The port at which a cargo is loaded onto a vessel and disembarks.
<b>Port of Discharge (POD)</b>	The port at which a vessel arrives and unloads cargo.
<b>Direct Service</b>	Vessel Schedule wherein cargo is loaded/unloaded from the same vessel.
<b>Transshipment Service</b>	A shipment where a container changes multiple ships throughout the transport, where cargo is offloaded at another port to connect to the vessel destined to the final point of delivery. There can be a single transshipment or multiple transshipments.
<b>Live Load / Unload</b>	When a forwarder or transport company sends or drops a container at a shipper's facility and waits for the container to be loaded / unloaded without leaving within a stipulated period of time.
<b>Drop and Pick</b>	When a forwarder or transport company leaves a container at a shipper's facility for one or more days without being present for the loading / unloading.
<b>Stripping</b>	Removing contents from a container, either at the port or consignee's location. May or may not involve breaking the container seal; a container may be opened prior to delivery for a variety of reasons including inspection and breaking down of a consolidated consignment. Also sometimes called destuffing or devanning.
<b>Stuffing</b>	Loading a container for shipping, at a container freight station, consignees' location or consolidation warehouse somewhere in the middle. Sealing the container may or may not occur at point of stuffing.
<b>Shipside / Quayside</b>	Storage and handling of cargo occurring at a port alongside or near a sea transport vessel.
<b>Berth</b>	A designated location in a port where a vessel can park and moor, usually along the long edge of a ship to provide safe and easy offloading. Maritime vessels vary dramatically in size, both in length and depth under the water they may draft, so berthing space must be designated by a port captain or port official, and must match the needs of the vessel.

<b>On Deck Stowage</b>	The placement of cargo and containers stored on the surface deck of a ship for the duration of the transport. On deck refers to anything above below deck storage with free access to the air above the boat, however on deck storage might still start below the upper rim of the vessel.
<b>Below Deck Stowage</b>	The placement of cargo below the main deck of a shipping vessel.
<b>Bulk Carrier</b>	A vessel specially designed to transport unpackaged bulk cargo, such as grains, coal, ore, steel coils and cement, in its cargo hold(s). Bulk carriers are ideal for transport of grain or loose materials that may be removed with special equipment on the receiving end. Frequently, bulk carriers will require re-bagging on the receiving end of the shipment.
<b>Break Bulk</b>	Cargo transported in large, unitised quantities not contained in a standard shipping container. Break bulk cargo may be items like large machine parts, construction materials or even vehicles, and can be stored in specialised below deck compartments.
<b>RoRo</b>	Any vessel that has capacity for vehicles to "Roll on / Roll off." Might include regular vehicle ferry service, but also many long haul ships may have this capability.
<b>Stevedore</b>	A dock worker engaged with loading, offloading and management of maritime shipping activities.

## Sea Transport Arrangements

Very rarely are sea cargo vessels owned or wholly leased by single agencies that also solely utilise them for their own shipping purposes. The overall size, cost, time and general nature of sea freight necessitates that no single entity but those with massive and regular volumes of cargo could ever utilise an entire vessel at once. The vast majority of sea cargo is arranged through freight forwarders, and is negotiated based on the POL/POD, consignment size, type and special handling needs. Shippers sending any goods via sea should liaise with their forwarders to identify the correct modality of moving their cargo from one place to another.

In sea shipping, there are heavily trafficked and well-known routes that many vessels use known as "shipping lanes," especially between high volume ports. Between these shipping lanes, there are also what is known as "shipping lines," or fleets of shipping vessels privately owned and managed by a company or a consortium. In addition to shipping lines, there are also a variety of smaller merchant fleets and individual vessels who work on contract for cargo movement.

Due to the sheer number of individual shippers that may be sending cargo on a single vessel, it's extremely unlikely any one vessel will be departing from and arriving at the exact destination specified by the shipper. Cargo shipped via sea faring vessel will frequently use transshipment service, being offloaded and reloaded onto two or more vessels while en route, staying in a secure port in between loadings while waiting for the correct vessel heading the correct destination. The linkages of a transshipment service are worked out by brokers and forwarders on behalf of the shipper, and shippers usually don't get involved with routing, only becoming involved with cargo at the final destination.

**Containerisation / Loose Item** – The preferred method of shipping via sea is the use of containerised units. Shipping containers, through their standardised construction, fit onto a

wide variety of sea faring freight vessels. Containers are usually sealed at the POL, and as such can switch between multiple vessels and ports while en route with minimal risk of tampering or theft. Generally, shippers should seek to maximise their shipments by trying to reach a whole number of either 20 foot (TEU) or 40 foot (FEU) container or containers. Loads smaller than a full container load (FCL) might have to wait until a full container load is available, otherwise shippers might have to rely on what is known as “consolidation,” or sharing of one container with one or more other shippers. Less than container load (LCL) cargo using consolidation might require waiting to find another shipper or shippers going to the same final destination as the shipper. Consolidation also does not allow for fully unopened containers to be delivered to a consignee’s facility as the cargo will need to be broken down and separated at the port, which increases the chances of loss or theft.

Special items such as generators or vehicles that cannot fit into a container, or special handling containers like refrigerated containers (reefers) may also be transhipped using two or more vessels. For oversized or bulky items, they may also be shipped by the piece, however there may be fewer available vessels with the right stowage space heading to the correct locations, which might drive up costs and slow down the entire process of shipping.

**Dedicated Charters** – Occasionally an agency or organisation will need to take full possession of a vessel for a single voyage or for an extended period of time. These vessel specific charters are governed by a contracting structure known as a “charterparty.” In a charterparty arrangement, the ship owner provides the vessel as a dedicated resource along with crew, and usually provides for the cost of fuel and maintenance, though the specifics of the arrangement are identified in the contract. Examples of dedicated charters in humanitarian aid might include:

- Leasing an entire bulk carrier vessel for the movement of loose grain from one location to another
- Long term leasing a cargo vessel to provide regular cargo service to locations not serviced by the commercial market
- Long term leasing of passenger vessels for special purposes (hospital boats, rescue boats, etc)

## Unique Concepts to Sea Transportation

**Port Demurrage** – Sea cargo in a port accrues demurrage at a different rate than airports or border crossings. Due to the size and complexity of port operations, containers and bulk cargo items are typically given two weeks of free storage before demurrage accrues. This port demurrage rate is variable however, and free demurrage may vary for container and break bulk cargo based on the carrier agreement with the port, the shipping line companies, and the local governments ranging from two days to fourteen days.

**Flag Carrying Vessel** – The majority of the surface area of the world’s oceans are considered international waters, and vessels themselves may spend the majority of their time in non-incorporated international water. By binding international maritime law, all vessels must still be registered as a “flag carrier” for some country on earth. A vessel carrying the flag of a certain country does not mean the vessel was manufactured there, nor does it mean the crew or anything about the operation is connected to that country, it only means that’s the country the vessel is registered in. By regulation, vessels must spend at least some portion of the year docked in the country through which they are registered. Regulation also states that the country to which the vessel is registered has the ultimate authority and responsibility to enforce safety and pollution standards, and prosecute any violators under local law.

**Vessel Limitations** – Modern shipping vessels are becoming larger and more sophisticated, however it is extremely difficult - and at times impossible – to update seaports to accommodate these ships for a number of reasons. Additionally, many vessels might require additional specialised [Material Handling Equipment \(MHE\)](#) that isn't always available in every port, especially under developed or neglected ports in countries prone to natural disasters and conflicts. Limitations vessels might face include:

- **Hull Draft** – Some vessels have drafts too deep for some harbours, which are limited by the natural topography of the ocean floor.
- **Offloading** – Smaller and unimproved seaports may lack the offloading equipment to move containers and bulky items. Vessels moving these items may need deck mounted cranes to move items themselves.
- **Size** – Vessels that are too long may not be able to adequately berth to offload cargo.
- **Flag Carrying Vessels** – Some vessels may be banned from entry to harbours due to their source origin or registered flag.

## Port Operations

Seaports can be enormous compared to other ports of entry, such as an airport or a border crossing. Seaports must be large enough to accommodate vessels of various sizes, but also can have an extremely large storage and holding capacity. The largest container ports in the world process tens of millions of TEU containers each in a single year. Large ports can be extremely busy, with dozens of ships being loaded and offloaded with specialised cranes and MHE at any given time. Ports also tend to be highly secured and scrutinised – due to the high volume of goods, illegal smuggling and human trafficking have become large concerns for many countries. Based on the sheer size of the operations, vessels may not be able to berth or off load for days or even weeks, instead having to moor off coast waiting for berthing space to open up. It's also very common for cargo to be delayed while being offloaded and moved around a port, especially in chaotic post emergency periods.

Port limitations can also impact the speed at which cargo can be offloaded, or even prevent offloading at all. Things such as the number of operating cranes, the number of available truck drivers or the available hands to move cargo may lead to significant port congestion. The lack of the appropriate handling equipment can adversely limit a port to the point it cannot service some vessels. In countries or locations with limited or unimproved facilities, it may be impossible to off load certain vessels. Small ports may lack cranes sufficient to move full sized containers or oversized cargo, requiring vessels to carry their own on-board MHE. Even if a port has proper MHE, if the equipment is old, poorly serviced, or the ground operators have limited or poor training, offloading and releasing cargo can be slowed down substantially.

Example Port Operation Overview:



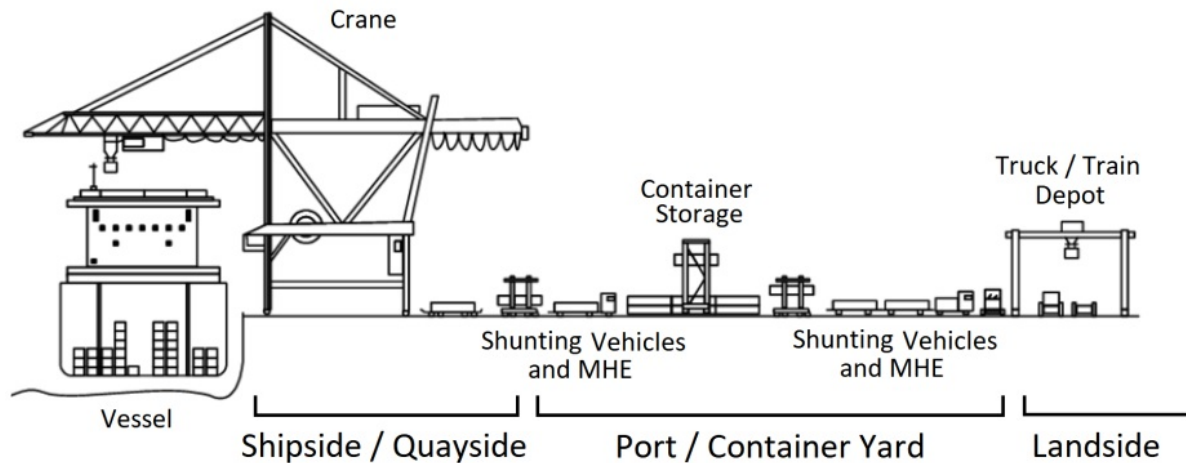

## Material Handling Equipment

Ports require specialised equipment to load and offload cargo from vessels. In sea operations, cargo normally arrives containerised, however cargo can also be oversized or bulk. Special equipment is required to properly load and offload items.

**Reachstacker** - Large vehicle designed to pick up and carry full-sized containers around a container yard. Reachstackers have different sizes, and may have maximum load limits under a fully loaded container. Reachstackers are usually not used for offloading vessels, unless the vessels are small and in unimproved port conditions - they are mostly used for rearranging containers in a shipping yard, or loading containers onto truck bodies for onward movement.



**Shipside Container Crane** - A large crane capable of offloading full-sized containers directly from the deck of a ship. Shipside container cranes may either be stationary, or capable of moving to meet the needs of the operation. The cranes are usually very tall - well above the decks of most vessels rated for that port and are capable of lifting loads up to the max weight of containers.



**Gantry Crane** - Another form of movable container crane, one that specifically straddles both side of a vessel or stack. Gantry cranes can be large enough to reach over the deck of an entire vessel, but may also be used for loading and offloading trucks or piles of cargo.



**Unloader / Grain Vacuum** - A specialised tool for offloading loose, bulk cargo such as grain or sand with an extended adjustable arm that reaches into the deck of a bulk carrier. Unloaders can have a mechanical function, scooping and lifting bulk cargo like an elevator inside the arm. There are also configurations where the arm is a giant vacuum for grains called a "grain vac", that pushes loose grain out the back to a pre-set destination.



**Ship with Deck Mounted Cranes** - Some ships may require their own onboard mounted MHE, such as deck mounted cranes. On-board MHE helps alleviate the problem of working within ports that have limited handling equipment.



**Grain Conveyor** - A large mechanical conveyor that can either lift and dump grain, or be used to slowly offload grain from the belly of a bulk carrier. If used for offloading, there is usually a bagging operation occurring at the receiving end.



## **Sending Goods by Sea**

## Sea Transport Documentation

The overall requirements for and types of documentation used for sea transport remain consistent with most shipments ([waybill](#), [packing list](#), [proforma](#), etc). There are documents specific to sea shipping however. These might include:

**Bills of Lading (BOL)** - The BOL is the transport waybill for a sea freight consignment. BOLs are conceptually one of the oldest mutually recognised forms of consignment tracking; traditionally seaborne trade was one of the few ways countries conducted official trade. The BOL states to whom and on what terms the goods are to be delivered at destination. It is one of the most crucial documents used in international trade in that it ensures the shipper receives their payment and the consignee receives their cargo, and without an official BOL the goods will not be released. Modern BOLs are highly standardised, and BOLs generated by different shipping lines will look almost identical in layout. Many shipping companies will require BOLs even if the vessel is not moving between two different countries – the BOL also represents a contract between the vessel owner and the owner of the good being shipped.

There are three types of BOL arrangements that can be used:

- **Original BOL** - Consignee has to handover all three sets of original BOLs to their customs agent at destination to release the cargo. With original BOLs, possession of the goods is determined by possession of the BOL - whoever possesses the original BOLs may be entitled to demand possession of the goods from the carrier. Shipments using original BOLs may be delayed if the documents are lost or not in hand at the time of clearing.
- **Seaway BOL** - Original BOL is not required and cargo can be released directly to the consignee by their customs agent. Seaway BOLs are useful because the physical document does not need to be present, and the consignee can begin clearing as soon as cargo arrives. Many banks do not accept Seaway BOLs if a letter of credit is required however.
- **Telex Release BOL** - In telex BOLs, the supplier surrenders the original BOL to their export/forwarding agent at origin and transmits using telex directly to customs at destination request to release of cargo to the consignee.

BOLs are usually issued in a set of three originals and several non-negotiable copies. The BOL is signed on behalf of the ship owner by the person in command of a ship or the shipping agent, acknowledging the receipt on board the ship of certain specified goods for carriage. It stipulates the payment of freight and the delivery of goods at a designated place to the consignee therein named.

The BOL is the major shipping document and has three roles:

- It affirms the contract of carriage and sets out the terms thereof. It is evidence of the contract between the consignor and the shipping line, and on the reverse details the conditions of carriage.
- It is the carrier's receipt for the carriage of goods by sea and is signed by the master or another duly authorised person on behalf of the ship owner, acknowledging receipt on board the ship of certain specified goods that he undertakes to deliver at a designated place.
- Possession of the original BOL gives the title to the goods being carried. It is considered good practice for the consignor to ensure that at least one original BOL reaches the consignee in good time since the consignee will receive the goods only against presentation of at least one original BOL.

## Terms of the BOL:

There are three different entries possible in the box headed "consignee":

- **To bearer:** this means that any person having possession of the BOL may collect the goods; such person is not required to disclose their identity or to explain how they came into possession of the BOL. The mere fact that they have possession of and present the BOL is sufficient. Issuing BOL "to bearer" is not common practice and carries significant risk.
- **To order:** this is the form of BOL used most frequently in commercial transactions. As long as the shipper holding the BOL has not endorsed it, he is entitled to dispose of the goods. By endorsing it, he transfers his rights to the endorsee, that is, the person to whom the BOL is assigned by endorsement. Title to the goods is thereby transferred to the new holder of the BOL who may in turn assign it by endorsement to somebody else.
- **To a named party (straight BOL):** in contradiction to a BOL "to order", the straight BOL - one in which it is stated that the goods are consigned to a specified person - does not entitle the shipper to dispose of the goods. That right is vested exclusively in the receiver who alone has the right to collect the goods, upon presentation of the BOL and proof of his identity. Named parties are by far the most common and secure form of named consignees.

Other commonly used BOL terms:

- **Straight BOL** - Assigned by means of a document instrument in writing, evidencing the assignment, which the assignee must present to the master of the vessel together with the original BOL when he collects the goods. On a straight BOL, the term "to the order of" printed on standard BOL must be crossed out, and the deletion initialled by both the shipper and the Master.
- **Clean BOL** - Declares there is no damage or loss of cargo in transit. Goods may sometimes be 'received alongside', which can result in a delay prior to the physical loading of the goods onto the vessel.
- **Unclean BOL** - Contains a notation that goods received by carrier were defective or damaged.
- **Through BOL** - Issued when a shipper wishes the carrier or shipping line to arrange for transport to a destination beyond the port of discharge. The through BOL, in addition to the agreement to carry goods from port to port, includes a further journey (by sea or land) from the port of ship's destination to a distant place (for instance, a destination inland instead of a port).
- **House BOL (HBL)** - An internal document generated by a forwarder or broker to provide relevant information to a client. HBLs may not always be presented as official documentation used during the customs process.
- **Master BOL (MBL)** - the official BOL generated by the shipping line or vessel operator. MBLs will generally bear the most accurate information, and many customs authorities will only use MBLs for customs clearance purposes.

Example BOL:

**MASTER  
BILL OF LADING  
Conocimiento de Embarque**

XXXXXX LINER SERVICES (2) SHIPPER (Complete Name, Address & Zip Code) Embarcador  Shipper's Name Mailing Address Including City, State and Zip Code		(3a) BOOKING NO. Reserva No. <b>CAT - XXXXXX</b>	(3c) SCAC Code <b>CAMN</b>	(3a) BILL OF LADING NO. Conocimiento de Embarque	
(5) CONSIGNEE (Complete Name, Address, & Zip Code) Consignado a: Not Negotiable unless consigned "To Order"  Consignee's Name Complete Mailing Address Including City, State and Zip Code		(4) EXPORT REFERENCES Referencias de Exportación FWDR REF. NO.		(6) FORWARDING AGENT Agente Embarcador-Referencias FMC NO. CHB NO.	
(7) NOTIFY PARTY (Complete Name, Address, & Zip Code) Dirigir Notificación de Llegada a:  Contact Information for Person to be notified at Destination include Full Name, Phone Number and/or E-mail Address		(8) ALSO NOTIFY - ROUTING & INSTRUCTIONS Tambien Notificar - Ruta Doméstica/Instrucciones de Exportación			
(9) VESSEL Nave	VOYAGE Viaje	FLAG Bandera	(10) PLACE OF RECEIPT *Carga Recibida en:  (13) PORT OF LOADING Puerto de Carga <b>Enter Port Delivered to</b>	(11) RELAY POINT Punto de Conexión  (14) LOADING PIER / TERMINAL Muelle	(12) POINT AND COUNTRY OF ORIGIN OF GOODS Lugar y País de Origen
(16) PORT OF DISCHARGE Puerto de Descarga <b>Enter Final Destination</b>			(17) PLACE OF DELIVERY *Lugar de Entrega de la Carga		(18) ORIGINALS TO BE RELEASED AT Originales para Entregarse en: <b>Enter Releasing Instructions for Original Bills of Lading</b>

**PARTICULARS FURNISHED BY SHIPPER**

(19) MARKS & NO'S/CONTAINER NO'S. Marcas y Números	(20) NO. OF PKGS. / CONT'S. / PIGGS. / No. de Paquetes/ Bultos	(21) HMT*	(22)	DESCRIPTION OF CARGO Contenido Según Embarcador	(23) WEIGHT Libras/Kilos	(24) MEASUREMENT Medidas
(25) ** HAZARDOUS DECLARATION - THIS IS TO CERTIFY THAT THE ABOVE NAMED MATERIALS ARE PROPERLY PACKED, LOADED, CLASSIFIED, DESCRIBED, MARKED, LABELLED, SEGREGATED AND ARE IN PROPER CONDITION FOR TRANSPORTATION ACCORDING TO ALL APPLICABLE REGULATIONS AS SPECIFIED IN CLAUSE 26. PROVIDE SHIPPER'S EMERGENCY RESPONSE CONTACT'S NAME AND TELEPHONE NUMBER INCLUDING AREA CODE IN THE SPACE PROVIDED.						

CONTACT: \_\_\_\_\_ TEL. NO. \_\_\_\_\_

Signature \_\_\_\_\_

FREIGHT CHARGES Flete	RATED AS Flete Básico	PER	RATE Tarifa	TO BE PREPAID IN US DOLLARS Prepagado en Dolares U.S.	TO BE COLLECTED IN US DOLLARS A Cobrar en Dolares U.S.	FOREIGN CURRENCY Moneda Local							
<table border="0" style="width:100%;"> <tr> <td style="width:40%;"><b>TOTALS</b></td> <td style="width:10%;"></td> <td style="width:5%;"></td> <td style="width:10%;"></td> <td style="width:15%;"></td> <td style="width:15%;"></td> <td style="width:20%;"></td> </tr> </table>							<b>TOTALS</b>						
<b>TOTALS</b>													

THIS BILL OF LADING CONSISTS OF CONDITIONS AND INFORMATION APPEARING ON THE FRONT AND BACK OF THE DOCUMENT  
SUBJECT TO SECTION 7 OF CONDITIONS, IF THE SHIPMENT IS TO BE DELIVERED TO THE CONSIGNEE WITHOUT RECOURSE ON THE SHIPPER, THE SHIPPER SHALL SIGN THE FOLLOWING STATEMENT "THE CARRIER SHALL NOT MAKE DELIVERY OF THIS SHIPMENT WITHOUT PAYMENT OF FREIGHT AND ALL OTHER LAWFUL CHARGES"

SIGNATURE OF SHIPPER \_\_\_\_\_

LIABILITY LIMITED UNLESS INCREASED VALUE DECLARED BELOW, ALL AS SPECIFIED IN SECTION 16:

DECLARED VALUE \_\_\_\_\_

\*\* APPLICABLE ONLY WHEN USED AS A THROUGH TRANSPORTATION BILL OF LADING

\*\* INDICATE WHETHER ANY OF THE CARGO IS HAZARDOUS MATERIAL UNDER DOT, IMCO OR OTHER REGULATIONS AND INDICATE THE CORRECT COMMODITY NUMBER IN DESCRIPTION OF CARGO ABOVE.

IN WITNESS WHEREOF THE CARRIER HAS SIGNED \_\_\_\_\_ ORIGINAL BILLS OF LADING, ALL OF THE SAME TENOR AND DATE, ONE OF WHICH BEING ACCOMPLISHED THE OTHERS STAND VOID.

BY \_\_\_\_\_  
CARRIER: LINER SERVICES

BY \_\_\_\_\_  
FOR SHIPPER

**Non-Traditional Movement** – there may be instances in which cargo is moved via a seafaring vessel in which no BOL is used. Such an instance might be when cargo is moved using ocean waterways without moving between two countries, when the sea carrier or vessel owner isn't large enough to participate in regular maritime shipping practices, and when natural disasters or conflicts preclude the normal procedures associated with sea shipping. In such instances, individuals or organisations should still endeavour to utilise standard shipping best practices, such as use of packing list and waybill, to prevent loss or theft along the way.

# Cargo Configuration for Sea Shipping

Cargo shipped via sea tends to require a lower attention to detail, especially if cargo is shipped using standard shipping containers. There are still a few things shippers should know when prepping cargo for sea movement however.

## Container Shipping

Modern [shipping containers](#) have standardised interior, exterior and door dimensions. Containers also have pre-defined weight limits, set by the structural integrity of the containers and the rating on the cranes and vehicles used to move them. Shipping container weight will often be discussed in the following terms:

- **Tare** – The weight of an empty container; weight generated by the container it self.
- **Net** – The weight of the goods placed in the container.
- **Gross** – The combined weight of the container and the contents of the container.

Containers may be made of different materials, altering the tare and gross weight availability.

Example container carrying vessel:

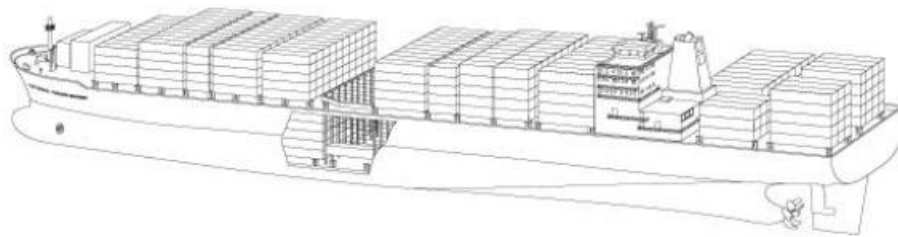

Though there are dozens of varieties of containers available to meet a number of needs, the vast majority of containers what are known as "dry containers" at either 20 foot (TEU) or 40 foot (FEU) sizes. TEU and FEU are totally enclosed, and though they are called "dry" are not actually hermetically sealed. The containers themselves are lockable and stackable, with two TEUs being able to be loaded on top of or below an FEU. Standard dry containers are mostly made from steel, however aluminium varieties are available.

As containers move, they are physically "sealed." A seal is usually a metal or plastic lock that can only be closed once. The only way to remove the lock is to physically cut it, thereby "breaking the seal." Container seals don't provide any form of structural security to the containers themselves, rather they are used as the process of tracking chain of custody. A proper container seal should have a tracking serial number on it. That serial number should be recorded at the point of sealing, and communicated to the ultimate recipient for cross reference. If the seal on the container at the receiving end does not match match the seal at the beginning of the journey, then theft or tampering may occur. Based on the volume of sea shipping, container numbers are frequently only checked if there is problem with the piece counts or product identification.

Container Chain of Custody:

- **Container Stuffing** - When an empty container is filled or "stuffed" with cargo to be shipped. Stuffing can be done either at the customer's location, or at the port. Stuffing can be the responsibility of the customer, or for a designated third party designated in

the terms of the contract.

- **Sealing the Container** - Sealing occurs after a container has been stuffed. Physically setting the seal can be the responsibility of the customer, or a third party company/agent identified by the customer.
- **Unseal the Container** - Breaking occurs at the end of the sea journey, and in the presence of the customer or the designated third party company/agent. Breaking can occur either at the port, or the container can be delivered all the way to the customer's location.
- **Container Stripping** - When a full container has its contents removed or "stripped" of its cargo. Container stripping can occur at the port, or at the customer's location, and is the responsibility of the customer or a designated third party designated in the terms of the contract.

#### Stripping/Stuffing Process

- When a container is dropped at a customer's location and left to be stuffed or stripped later, it is called "drop and pick." Drop and picks can be for a specific pre-defined interval, or they can be for as long as required by the client/contract. Drop and picks are good for clients who like to stuff/strip and seal/unseal containers themselves.
- When a container is stuffed at the time the container is made available, it is called "live loading." Live loading is the same process as loading onto a box truck, and usually containers are truck mounted if at a customer's facility.

#### Example Container Seals:



The process of stuffing/Stripping and sealing/unsealing can be entirely outsourced to a third party. Many organisations who deal with less than full container loads rely on consolidators or third parties to take and ship their cargoes for them, ensuring all formalities are taken on their behalf. Self managed stuffing/stripping and sealing/unsealing is largely only useful for shippers who move large volumes of cargo and have robust supply chain monitoring processes in place.

When planning shipments in an TEU or FEU, shippers should consider the width, height, and total volume of a container. As an example, the interior width of a standard FEU is just under 2.4 meters while the width of [a standard north American pallet is just over 1 meter on the short end while just over 1.2 meters on the long end](#); loading using this pallet type using any side by side configuration will inevitably mean losing some usable free space. The same goes for oversized pallets – pallets of excessive height will not be able to fit through doors if they



exceed the door height, especially if pallets are moved by a hand truck or other form of MHE, meaning there will still be several centimetres of clearance required for the pallet to be picked up off the ground.

Cargo that is loose loaded into a container by hand may be able to fill up every available space, but loading and offloading cargo by hand can take extremely long periods of time. Unless a transporter is willing to do a drop and pick, the use of handloading may even be prohibitive. Additionally, many containers may be emptied and transloaded onto another truck where intermodal arrangements are not available, which would delay the process even further while increasing the risk of damage to cargo. In large scale response operations, shippers may opt to use palletised loading just to speed up the front and rear ends of the delivery.



#### TEU and FEU Dry Container

Type	Container Weight			Interior Dimensions			Door		
	Gross (kg)	Tare (kg)	Net (kg)	Length (m)	Width (m)	Height (m)	Capacity (m3)	Width (m)	Height (m)
20 ft	24,000	2,370	21,630	5.898	2.352	2.394	33.2	2.343	2.28
40 ft	30,480	4,000	26,480	12.031	2.352	2.394	67.74	2.343	2.28

Title

Download Guide - Container Specifications

File



Outside of the standard TEU and FEU dry container, there are several common types of shipping containers to meet different needs.

- **Open Top/Side** - Some containers come with open tops or open sides to accommodate oversized cargo such as vehicles. The containers will still have bases of regular dimensions to facilitate stacking and moving via cranes, however.
- **Oversized** - Some containers are made especially long or especially high to accommodate larger loads. Only special vessels and ports can accommodate this type of container however.
- **Cold Storage** - Cold storage or refrigerated "reefer" containers are used for transmission of any climate controlled or cold chain items. Reefer containers are designed to transport cold requirement items over the entire sea voyage, and require constant connection to electricity or fuel to maintain low internal temperatures. Self-contained reefers can technically be transported on any vessel that can accommodate regular TEUs and FEUs, but special training and handling may be required.



#### Refrigerated "Reefer" Containers

Type	Container Weight			Interior Dimensions			Door		
	Gross (kg)	Tare (kg)	Net (kg)	Length (m)	Width (m)	Height (m)	Capacity (m3)	Width (m)	Height (m)
20 ft	24,000	3,050	20,950	5.449	2.29	2.244	26.7	2.276	2.261
40 ft	30,480	4,520	25,960	11.69	2.25	2.247	57.1	2.28	2.205



### Open Top Containers

Type	Container Weight			Interior Dimensions				Door	
	Gross (kg)	Tare (kg)	Net (kg)	Length (m)	Width (m)	Height (m)	Capacity (m3)	Width (m)	Height (m)
20 ft	24,000	2,580	21,420	5.629	2.212	2.311	32	2.33	2.263
40 ft	30,480	4,290	26,190	11.736	2.212	2.311	64.4	2.33	2.263



### High Cube Containers

Type	Container Weight			Interior Dimensions				Door	
	Gross (kg)	Tare (kg)	Net (kg)	Length (m)	Width (m)	Height (m)	Capacity (m3)	Width (m)	Height (m)
20 ft	30,480	3,980	26,500	12.031	2.352	2.698	76.3	2.34	2.585
40 ft	30,480	4,800	25,680	12.031	2.352	2.698	86	2.34	2.585



### Flat Rack Containers

Type	Container Weight			Interior Dimensions				Door	
	Gross (kg)	Tare (kg)	Net (kg)	Length (m)	Width (m)	Height (m)	Capacity (m3)	Width (m)	Height (m)
20 ft	30,480	2,900	27,580	5.898	5.624	2.236	27.9	N/A	N/A
40 ft	34,000	5,870	26,480	28,130	11.786	2.236	27.9	N/A	N/A

Title

Download Guide - Container Specifications

File



### Pallets in Containers

Transport of cargo in containers is frequently done utilising pallets.



Based on the pallet types, different quantities might fit into different containers. In the situation pallets are not too tall to fit through container doors, a general guide for estimating pallets per container is:

Pallet Type/Size	Pallets per Container	
	20 Ft Container	40 Ft Container
<b>Euro Standard (120 x 80 cm)</b>	11	23 or 24
<b>Europe, Asia (120 x 100 cm)</b>	10 or 11	20 or 21
<b>North American (121.9 x 101.6 cm)</b>	10	20

### Oversized Cargo

Sea shipping is ideal for extremely large cargo; the cargo holds of larger ships can handle excessively large items, while the MHE used in port operations can handle weights not common in air or trucking. For transportation of oversized items, shippers must obtain proper exterior dimensions, and in the case of machine equipment, should obtain detailed material handling specifications available from the manufacturer or in the equipment manual. Non containerised shipments may take some time to formalise, as a break bulk carrier with the appropriate size hold and free space may not be readily available. Additionally, it may be difficult to find vessels utilising the correct routing to arrive at a shipper's intended destination. Shippers should begin conversations early with forwarders to determine the time and information needs to successfully ship bulk cargo.

### Bulk Dry / Loose Cargo

Sea faring vessels have a unique capacity to carry enormous quantities of un-packaged bulk cargo; cargo that is loose dry cargo such as grain or ore. Bulk carriers can hold high volumes of loose items in one or a few large cargo holds in the middle of the vessel. Unlike containerised vessels, it is highly unlikely that bulk carriers would undergo a transshipment process – the act of getting loose bulk off and back on a ship is very energy intensive. Bulk carriers require special equipment and training to load and off load. Loading can occur with cranes or grain elevators, while offloading requires special cranes to scoop or even suck up fine granules. Depending on the needs on the ground, bulk cargo operations might even undergo bagging directly at the point, to facilitate quick loading onto trucks for onward movement. Bulk cargo vessels are common for food operations in humanitarian response.

## Physical Cargo Needs

Due to the long duration of sea shipping, shippers should be mindful of cargo that may have sensitivities to temperature, or have specific expiration dates. Cargo shipped in a container along regular shipping lanes may easily take up to two months to reach its destination, especially when customs clearance and demurrage are taken into account. Containers will remain sealed, and will be exposed to the sun and elements throughout the duration of its journey, meaning contents can be subject to extreme heat or extreme cold.

- **Medical cargo** – Pharmaceuticals and consumables that have expiration dates must be handled with transit times in mind. Many countries won't import medical goods with less than 18 months of shelf life left, a time constraint that starts at the point of customs. This means medical goods must be procured and shipped with even longer shelf lives. Shippers should know the import procedures of the intended destination and plan accordingly. Temperature sensitive items may need reefer storage, even if not expressly stated by the manufacturer.
- **Food stuffs** – Containerised food items should be prepped for long storage – special temperature requirements must be identified up front, and fumigation may be required prior to loading.
- **Dangerous Goods** – Sea shipping standards around dangerous goods are less stringent, but must still be accounted for. Some DG items are reactive to metal, meaning long term exposure to shipping containers might actually damage the container resulting in additional cost to the shipper. Other DG items become combustible with increased heat – even though cargo at origin or destination may not be exposed to extreme temperatures, containers can be offloaded and held in extremely hot climates while waiting transshipping on another vessel. For an overview of the process of shipping dangerous goods by sea, please review the [Dangerous Goods section of this guide](#).

## Planning Sea Movement

In planning movements by sea, port capability and the control of port activity needs to be understood in order to assess any possible constraints that could impede the movement of goods. The following factors will indicate the suitability of a port to handle the planned movements:

- The number, type and size of ships that can be handled at one time.
- Typical vessel waiting and discharge times.
- Availability of equipment to handle different types of consignment – for example, bulk, bagged, loose, containers etc., and its state of repair.
- Availability of labour, working hours and typical discharge rates for both manually.
- Unloaded cargo and containers.

- Operational factors that may constrain activity such as the risk of congestion or the impact of the weather at certain times.
- Port documentation requirements and the efficiency of procedures for clearing cargo.
- Storage facilities and infrastructure such as railways, roads.

Where the movement of goods is to an area under the control of the local public authority, a clear understanding of the requirements covering movement of goods must be obtained from the appropriate authority prior to initiating any movement.

## Road Transport

Road transport is by far the most ubiquitous methods of moving cargo globally. Road transport also happens to be something that individuals or shippers can easily managed directly without having to go through a broker or third party. Trucks and vehicles can frequently be sourced locally, even in the early days of an emergency response, though quality of vehicles and roads may vary.

## Common Terms in Road Transport

<b>Transloading</b>	The act of loading goods directly from one truck to another truck, frequently done at border crossing points or points at which ownership changes hands. Can be used to speed up delivery to final destination.
<b>Tractor</b>	A powered vehicle with a heavy-duty engine specifically designed to pull large loads on trailers. Tractors usually run on diesel fuel, have multi-ratio gears, and come in the form of a large cab.
<b>Trailer</b>	An unpowered, multi axle platform that is pulled by a tractor. Trailers can have many configurations, including being flat surfaces, enclosed, refrigerated, two part (close-coupled) or some variation of therein.
<b>Semi-truck / Tractor Trailer Truck</b>	The combination of a tractor coupled with a trailer, joined with an articulated joint (drawbar) that enables enhanced manoeuvrability.
<b>Single Unit Truck / Straight Truck</b>	A truck where the cab and the truck bed section are permanently connected, and joints are not articulating. The wheels under the bed section can be powered from the main engine giving all-wheel drive and additional grip and handling on the road.
<b>Axle</b>	A rotating shaft that connects wheels on either side of the base of a vehicle. Trucks are often described by the number of axles they have. A higher number of axles may be required for heavier loads or unimproved/off road conditions.
<b>Shunting</b>	Sometimes referred to as "shifting". The act of transporting cargo over short-haul distances between near-by and often predefined locations, such as between a sea port and a warehouse, or within a defined property. Shunting vehicles may require less special equipment and may incur less wear and tear, and often operate in urban environments. Some shunting operations use specially designed tractors to move trailers on to facilitate quick parking, unloading, loading, and staging for departure

<b>Long Haul</b>	The act of moving cargo over long distances, comprising days or weeks and possibly crossing international boundaries. Long haul trucking may require cooking and sleeping amenities for drivers, repair equipment on board at all times, long range communication equipment, and may require off road capabilities.
<b>Lift Gate</b>	A self-powered platform connected to the rear of a truck that will lift pallets/heavy cargo without the need for manual loading. Sometimes also called a "lifting platform."
<b>Intermodal</b>	The act of switching between two modes of transport. In trucking, intermodal frequently refers to the use of shipping containers that can be loaded between different vessels and vehicles as a single unit without having to offload cargo.
<b>Porter</b>	Human, hand loading and offloading. Porters are heavily used in humanitarian contexts.
<b>Bonded Trucking</b>	A truck that is hauling cargo that is yet uncleared through customs into a country. Bonded trucking is highly regulated and comes with additional security precautions that must be complied with. Bonded trucking is typically for short-haul activities, such as moving cargo from an airport to an off side bonded storage facility, but also commonly used while in transit across multiple countries.

## Road Transport Arrangements

### Self-managed Owned or Rented Vehicles

Agencies running operations of any length in any context may wish to buy, rent or lease vehicles that are solely dedicated to and under the management of the agency itself. If an organisation decides to acquire its own vehicles, there are a number of areas to be considered, such as the type of vehicle and body type. The nature of the emergency response operation may also require that mechanical handling aids need to be incorporated into the overall vehicle specification to facilitate loading and offloading. Rented and owned vehicles can be sourced locally, or they can be imported into the response operation at the behest of the organisation. Bringing in outside vehicles might be the best way of finding the best or most appropriate equipment, but may take a long time to acquire and cost a large sum of money depending on the distance to delivery and the type of transport used. Vehicles brought from a different country will also need to undergo regular customs formalities.

Be aware that some countries do not allow particular models to be imported. This is due mainly due environmental or economic reasons. In some cases, countries put extremely high import and/or registration taxes to protect their manufacturing market. If agencies are looking to import a vehicle, it is of paramount importance to find out the official and practical procedures for import.

#### Advantages to self-managed vehicles:

- **Purpose Built** – Rented or owned vehicles can be designed, modified or built specifically to carry a particular product, such as cold chain items, which might require special handling.
- **Self Managed Drivers** – Organisations in total control over their vehicles will be able to train and supply their own drivers, which will allow for development, specialisation and quality control in case of performance issues.
- **Customisation** – Rented or owned vehicle can be outfitted with logos and visibility, and

can have customs communications equipment installed and configured.

- **Quality Control** – Using a self-managed vehicle it's much easier to ensure that the vehicle is used in an appropriate and ethical manner befitting of the agency.

#### **Disadvantages to self-managed vehicles:**

- **Time and Complexity** - Self-management of vehicles and fleets can occupy a great deal of time, and require excessive attention from management.
- **Special Knowledge** – Maintaining one or more shipping vehicles requires special skills and knowledge. Unless outside arrangements are made with third party repair services, organisations will have to identify and contract mechanics, and manage their own supply chain of spare parts. Dispatch and fleet management is also its own special skill, and requires knowledgeable and trained staff for coordinating movement of multiple vehicles.
- **Costs** – the start up and investment capital to obtain vehicles, drivers and parts can be substantial, and aid agencies limited to grant funding may not be able to cover costs all at once. Operating in many contexts will also incur substantial insurance costs as well. An owned vehicle must be managed until its property is effectively transferred to another party, including the update of property records by the local authorities. The organisation can be held accountable for any liability related to the vehicle during the ownership period.
- **Single Point of Failure** – Organisations that own or manage their own vehicles run the risk of mechanical issues or an accident completely halting use of that vehicle at any time.

Drivers are an essential component to self-managed trucking fleets, equally as important and the vehicles themselves. Even if an organisation has a perfectly maintained fleet, if they are using poor quality drivers, have drivers who are not licensed to operate in any given context, or don't invest in training drivers, then accidents, damages, cargo loss and possibly issues with fines or law suits may occur. Agencies seeking to maintain their own vehicles and have a staff pool of drivers should ensure that the hiring practice is transparent and skills and knowledge are clearly demonstrated. When recruiting drivers, agencies might consider:

- Asking for documentation to prove authorised license to operate the vehicle in question
- Request a background check
- Ask the applicant to demonstrate their driving skill first hand in a safe location
- Have technical questions prepared
- If possible, enact a drug screening program

## **Third-Party Transport**

Humanitarian organisations have become increasingly reliant on third-party transport providers as a method of moving cargo into and around response operations. The overall running cost of using third-party companies may be higher, but in the volatile nature of response activities, outside companies can help start operations quickly, and organisations can start or stop operations as quickly as needed without concern for what to do with large physical assets like trucks. Even if an organisation owns its vehicles, there may well be occasions when a need arises for additional capacity to meet peak activity or other short-term needs. This can be met by the use of vehicles supplied by a third-party commercial transport provider.

Third-party transport companies can usually be sourced locally within or near the emergency context, and utilising them also serves the function of putting money into the local economy and fostering local acceptance of the aid agency in question. Organisations should follow all due diligence when soliciting and selecting third-party transport companies, and follow their

own internal procurement procedures wherever possible.

### **Advantages of third-party transport:**

- **Flexibility** - Organisations can use commercial providers to meet fluctuating demand requirements
- **No Size Constraint** - Organisations that may only ship infrequently, or only ship small quantities and may not need self-managed vehicles on hand at all times. Third-party transport caters to variable loads and journeys.
- **Lower Upfront Cost** - Third-party transporters will have virtually no start-up costs, and the transporter may be able to offer a more cost-effective and a more efficient service by sharing loads with other shippers.
- **Reduced Complexity** - The administration of vehicles and drivers is no longer the responsibility of the organisation, allowing the administration teams of the organisation to focus on other areas.
- **Local Knowledge** - Third-party transporters or providers may have better working knowledge of country requirements, local restrictions, geography, vehicle requirements or limitations, optimised routes, sticking points and more.

### **Disadvantages of third-party transport:**

- **Ethics Concerns** - Third-party transporters don't directly represent a contracting organisation, and as such may engage in activities aid agencies might find unethical, such as transporting equipment for parties to a conflict or employing child labour. Driver standards are also not controlled by the shipper, and activities such as drug use or unsafe driving may occur.
- **Additional Risk** - Though shippers may utilise additional insurance, there is always an increased risk using third-parties who may have less vested interest in the delivery of aid cargo.
- **Higher Long-term Cost** - Though start up costs may be substantially less with third-party transporters, over a long enough period of time and with enough cargo, third-party commercial transport may always be higher per kg. Organisations who are in a long-term programme and ship high volumes of cargo might encounter cheaper costs through renting or owning their own self-managed vehicles.

### **Considerations for both third-party and self-managed cargo transport:**

Whether the vehicles being used are owned, hired or are managed by a third-party, it is important to ensure that all local laws relating to the licensing, insurance and regulation of vehicles are adhered to:

- Drivers have a legally obtained licence to operate the class of vehicle they are driving on public roads and highways.
- Fees are paid for specific loads such as oversized or hazardous goods.
- Vehicles should be insured to at least the minimum required by law. Different organisations will have internal policies regarding the extent to which their own vehicles should be insured
- Vehicles may also require documentation relating to the maximum permissible weights in terms of gross vehicle weight, axle weight and payload.

### **Third-Party Trucking Rates**

How third-party trucking companies choose to charge for transport services depends on the country, the context, the anticipated needs of the contract, and even local norms and



regulations. Common arrangements:

<b>Pre-Defined Route</b>	Many trucking providers like to develop contracts based on pre-defined routes. The contract will stipulate a pre-established rate between two locations, expressed as either the cost of the whole vehicle, or as a rate per kg. Pre-defined route based rates are good for agencies that have a known project plan with known and commonly used destinations. Soliciting tenders based on route based rates will help planners easily identify which trucking providers are more cost effective in which areas.
<b>Time-Bound</b>	In some situations, planners and transporters may wish to specify contracts based on specific time intervals, usually daily or hourly rates. Time-based rates might be useful in the early days of a response, especially daily leasing of trucking services. Time-bound rates may also lead to poor cost controls however - if a vehicle is delayed for whatever reason, renters of the trucking service will be obliged to pay for those days unless otherwise clearly specified in the contract.
<b>Distance Based</b>	Some contracts are expressed as a rate per distance - usually kilometres - and charge renters of truck service per kg or vehicle. Distance based contracting may be similar to pre-defined routes, however it may be used when planners don't know all final destinations for delivery in advance. Planners should be careful with distance based rates - unless they have detailed knowledge of routes, they may have no way of validating actual distances covered. Planners may also want to implement a vehicle log book to track driver movements.

## Chargeable Weight

In most humanitarian contexts, the only constraints to loading a vehicle are the weight of the cargo, and if the load is oversized. There are some situations in which trucking companies may charge based on what is known as "volumetric weight." Volumetric weight can be applied when cargo is very light compared to its volume. If a humanitarian agency is leasing an entire truck the density of cargo may not be important, however in situations where an agency is being charged per kg, trucking companies may include minimum volumetric weights to help recover operating costs. Planners should assume that light, volumetric cargo may be charged at a different rate.

There is no one universal standard for volumetric weight, however a good indicator of volumetric weight might be:

$$\text{Metric} \quad (L \text{ (cm)} \times W \text{ (cm)} \times H \text{ (cm)}) / 333 = \text{Volumetric Weight (KG)}$$

## Unique Concepts to Road Transportation

### Vehicle Selection

It is important to be able to select the appropriate vehicle for the purpose required even if, at a later stage, it is necessary to revise this choice to reflect availability in the field. See below a description of the main body types and combinations that are available.











### Body and Size

The overall size of the vehicle is largely tied to the load in question. There are many factors that might limit the weight of a vehicle, including local infrastructure, road conditions, local laws

and even the overall quality of the vehicle itself.

Often times vehicles are referred to a weight rating, such as a twenty-tonne or forty-tonne vehicle. These tonnages referred to by the vehicle classification are specifying the maximum gross weight of the vehicle, which includes the weight of the cargo and the weight of the vehicle itself. These specific designations are important for route and transport planning, as many roads, surfaces and bridges are rated for different tonnages for a variety of structural or environmental reasons. This means that the actual weight of the cargo payload per vehicle will be moderately less, depending on the vehicle.

The actual maximum allowable payload weight per vehicle will be specified by the manufacturer, and can also be regulated by national or local regulations. The overall body and engine type of the vehicle will also impact the specific maximum payload of the vehicle. For the purposes of planning, the size to payload needs can be defined as in the table below:

Type	Axles	Max Gross Weight (Tonnes)	*Estimated Payload (Tonnes)	Typical Total Body Length (Meters)	Body
Single Unit Truck	2 axles / 4 wheels	3.5	1	Various	
Single Unit Truck	2 axles / 6 wheels	7.5	3.5	Various	 
Single Unit Truck	2 axles / 6 wheels	18.8	12	12	
Single Unit Truck	3 axles	26	18	12	
Single Unit Truck	4 axles	36	25	12	
Tractor Trailer Truck	3 axles	26	18	16.5	
Tractor Trailer Truck	4 axles	38	24	16.5	
Tractor Trailer Truck	5 axles	40	24	16.5	
Tractor Trailer Truck	6 axles	41	27	16.5	

Type	Axles	Max Gross Weight (Tonnes)	*Estimated Payload (Tonnes)	Typical Total Body Length (Meters)	Body
Close Coupled Trailer	Various	40	26	18.75	

\*The estimated payload is the weight of goods that can be carried without exceeding the maximum gross vehicle weight. Where law does not specify a maximum gross weight or local circumstances allow, this payload may be increased. For high volume / low weight cargo, the load may reach maximum capacity before weight limits are met.

### Generic Body Types

The desired vehicle body/trailer type will vary according to the goods or materials being carried, the terrain, the distance, and the prevailing security conditions on the ground. There are many variants of body/trailer type available. Generic body types might include:

**Flatbed / Platform** - The simplest and cheapest body type, comprised a flat surface resting on the axles with no sides or protection. Flatbed/platform bodies provide all round access to the load, but offers little security or protection from the weather. Loads carried using the open sided flatbed/platform vehicle will need to be secured using netting/ropes, and will likely need to be covered with plastic or tarpaulin to protect against the elements. Trucks in many humanitarian contexts might use the equivalent of a flatbed truck with built up side walls – this method helps protect against items falling or being taken from the interior of the load, but will still require covering with some form of tarp.



**Box truck / Van body** - A truck body with hard and rigid sides that enclose the platform completely. This body type reduces the payload of the vehicle due to the fact the physical structure adds weight, but provides protection for a perishable product and added security. Construction of the external body will depend upon the needs for insulation, waterproofing or strength. Access is usually provided by a rear door. Sometimes a door will be built into one, or both, of the body sides for special access. Box/van trucks are also ideal for special needs situations, such as refrigerated loads.



**Curtain Side / Drop Side Bodies** - Curtain sided / drop side bodies overcome the disadvantages of access; the full bed can be exposed by either pulling back a curtain or dropping the side of cargo space. This improves the speed of loading as well as unloading. Advantages of load restraint and weather protection are maintained, while body weight might less than the box

body. Curtain sided /drop sided bodies are less secure however, as contents are easier to access and cannot always be locked.



**Tankers** - Designed to carry powders or liquids, usually shaped in a way to prevent the vehicle from tipping over due to shifting weight. Tankers require a pumping mechanism and hoses to discharge the load, and some tankers have pumps built right into the back.



**Bulk Carriers** - Built similar box bodies, only without the roof. Bulk carriers are useful for large loads of loose goods that don't require typical manual loading, such as grains, gravel, or even fruits. Bulk carriers might have a mechanical tipping mechanism built right in, otherwise offloading bulk items may be done by hand and very time consuming. Bulk carriers are typically covered with tarp.

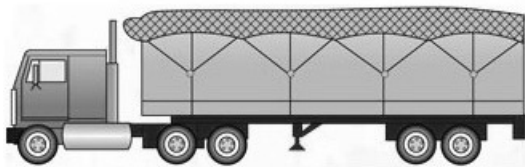

**Double/Close-Coupled Trailer** - a tractor pulling more than one trailer, linked like a chain. A double trailer configuration adds more weight to the load as more axles and connections are required, but adds increased manoeuvrability.



## Vehicle Manoeuvring

Trucks in all of their forms are by their nature difficult to manoeuvre, having special difficulty turning around and backing up. Aid agencies planning cargo operations using trucks must keep the turning and parking needs of vehicles in mind for planning purposes.

When contracting or purchasing trucks for consistent use in or around warehouses, the available parking, loading/offloading and turning space available for the vehicles must be taken into account. Many warehouses have enclosed fencing or walls, and may only have one single entry gate. Any vehicle used for pick-up or delivery must be able to enter the space, turn around and back up if needed. Additional consideration must be taken if multiple truck loads are to be enacted at once – will one truck inside being loaded/offloaded prevent another truck from entering, leaving or manoeuvring?

Long haul vehicle movements may be along narrow roads with no shoulders, cross roads or turn around space. An especially long truck may not be able to turn around if needed while en-route, and may need to reach its destination or next large intersection, which may be hours or days away.

At any time and regardless of the terrain, persons operating trucks must remain aware of height and width limitations of tunnels, underpasses, alleyways and enclosed parking areas, and must remain aware of weight limitations of bridges. When evaluating the size and weight limitations of vehicles, operators must also take the size and weight of cargo into account as well. A vehicle may be able to operate along a regular route under normal conditions, however an oversized cargo load may impact operating conditions.

Below is a general guide for vehicle turning radius. Planners should note that actual turning radius depends on the vehicle, and different makes and models will have some differences.

**Single Unit Truck Body:**

Vehicle Length (m)	Safe Turning Radius (m)
6	18
7	21
8	24
9	27

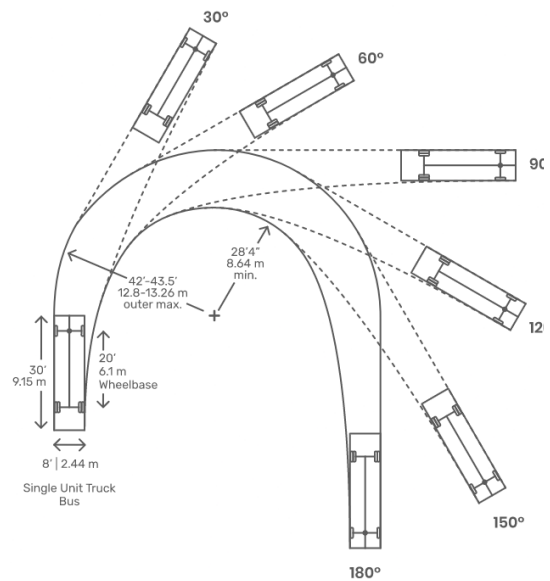

**Articulating Tractor Trailer:**

Vehicle Length (m)	Safe Turning Radius (m)
12	26
14	29
19	41
25	54

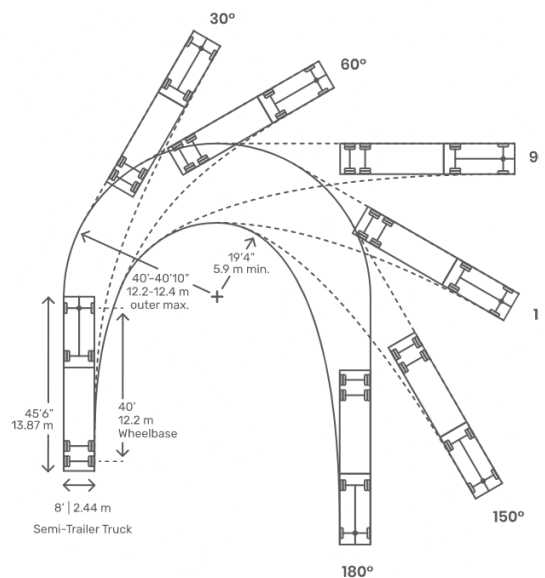

A quick reference guide to vehicle body types and vehicle manoeuvring can be [downloaded here](#).

# Sending Goods by Road

## Road Transport Documentation

There is no universal standard to documentation used for cargo shipped by road.

**Domestic truck movement** - In the majority of situations in which aid agencies operate, most cargo movement on roads operates domestically, which doesn't require international customs clearance. Domestic cargo movement can be tracked in variety of ways, but the most common is a waybill. Many third-party transporters can use their own waybills, however agencies may wish to utilise waybills in their own formats. Organisation specific waybills tend to take specific needs into account, such as accounting for metric tonnage or tracking based on batch/lot number of medication, things which may not be tracked in the waybill provided by a transport company. Shippers are encouraged to use the [standard set of shipping documents](#) for all domestic movement.

**International Truck Movement** - Many countries globally recognise what is called a "CMR" international waybill. The CMR was proposed and agreed upon under the [United Nations CMR Convention of 1956](#), and subsequently adopted by the [International Road Transport Union](#). The CMR functions similar to an Airway Bill (AWB) or Bill of Lading (BOL) in that it is a standard and uniformly recognised document for the transport of goods between two countries. Where formally recognised, CMRs are also part of the formal customs process and are asked for by customs officials, and designates roles and responsibilities of parties. The CMR does not take the place of a regular waybill - all traditional documentation may be still be required, and formal customs procedures for importation must be respected - but the CMR standardises the language for authorities to understand the nature of goods either being imported into a country, or across a country. It is important to note that the CMR is not recognised everywhere in the world, there are currently only 45 countries who recognise the CMR, consisting mostly in Europe, the Middle East and Central Asia.

Example CMR:

**LETTRE DE VOITURE INTERNATIONALE**



**INTERNATIONAL CONSIGNMENT NOTE**

**SF**

COPY 1 SENDER  
COPY 2 CONSIGNEE  
COPY 3 CARRIER

2  
GOODS FOR  
HAZARDOUS  
INDICATE  
1. UN NUMBER  
2. PROPER  
SHIPPING  
NAME  
3. HAZARD  
CLASS  
4. PACKING  
GROUP  
5. OTHER  
CONTENTS  
6. RESIDUAL  
7. RID

Approved by FT/AF/HA/SIT/PHO UK 1981

46020000 61700 250000 072000

Sender (Name, Address, Country) Expéditeur (Nom, Adresse, Pays)		1	Customs Reference/Status Référence/designation pour mise en douane	2
			Senders/Agents Reference Référence de l'expéditeur/de l'agent	3
Consignee (Name, Address, Country) Destinataire (Nom, Adresse, Pays)		4	Carrier (Name, Address, Country) Transporteur (Nom, Adresse, Pays)	5
Place & date of taking over the goods (place, country, date) Lieu et date de la prise en charge des marchandises (Lieu, pays, date)		6	Successive Carriers Transporteurs successifs	7
Place designated for delivery of goods (place, country) Lieu prévu pour la livraison des marchandises (lieu, pays)		8	This carriage is subject, notwithstanding any clause to the contrary to the Convention on the Contract for the International Carriage of Goods by Road (CMR) Ce transport est soumis nonobstant toute clause contraire à la Convention Relative au Contrat de Transport International de Marchandises par Route (CMR)	
Marks & Nos; No. & Kind of Packages; Description of Goods* Marques et Nos, No et nature des colis, Designation des marchandises*		9	Gross weight (kg) Poids Brut (kg)	10
			Volume (m³) Cubage (m³)	11
Carriage Charges Prix de transport		12	Senders Instructions for Customs, etc... Instructions de l'Expéditeur (optional)	13
Reservations Réserves		14	Document attached Documents Annexés (optional)	15
			Special agreements Conventions particulières (optional)	16
Goods Received/Merchandises Reçues		17	Signature of Carrier/Signature du transporteur	18
			Company completing this note Société émettrice	19
			Place and Date; Signature Lieu et date; Signature	20

FORM REF: 730 CMR

A map of countries that currently recognize and use the CMR in some format:



Source: [Wikipedia](#)

Countries who don't currently utilise the CMR will have their own means of importing cargo, depending on national laws and regional trade arrangements. Prior to importing goods to any country of operation through road transport, shippers and consignees must investigate the import and export laws for both countries.

Unlike air and sea freight which can pass over or around countries relatively unnoticed, many international shipments using trucking will be required to pass through the territory of one or more additional countries to reach their destination. In order to facilitate this process, vehicles may have to travel with what is called a "through bill of lading." The through bill of lading should contain the relevant information required by the countries through which the vehicle is passing. Vehicles transiting through third-countries may also be subject to enhance scrutiny and inspection, or be required to take additional security protocols to ensure cargo does not enter the local market without undergoing customs. In some cases, banned substances will not be allowed to pass through a country's national borders at all, even if the final destination is another country.

Occasionally, national laws and the policies of individual transport companies prohibit trucks from crossing borders all together. To mitigate this problem, many states of adopted pre-defined transshipping points at specific places along their borders. At these points, cargo can be offloaded and placed in temporary storage, or even transloaded directly to another vehicle. When this border transshipment occurs, all relevant documentation will still travel with the cargo.

## **Route Planning and Scheduling**

Route planning is the process of planning the movement of a particular quantity of goods in vehicles of known capacity. It assumes that goods are supplied from a fixed depot or starting point and that the location of individual customers is known. It recognises that restrictions on vehicle operations do occur, due to such factors as constraints on working hours, safety and security constraints, the total length of daily travel possible and the volume that can be moved within a normal working day. An acceptable solution to the route planning and vehicle-scheduling challenge should provide optimum routes that satisfy the demands of the work load, take account of legal requirements and reflect the efficient and cost effective use of the operator's resources.



A satisfactory solution should provide a schedule of routes that minimise either total distance or time travelled by vehicles. Route planning involves an assessing all possible routes, applying the following operational conditions:

- The number of calls to a particular delivery point in any single day is limited.
- The total vehicle travel in any day is limited and the driver's time is limited.
- Vehicles have a fixed carrying capacity.
- Whether the roads are suitable for the specific transport needs and vehicle, including road conditions, hairpin turns, and any narrow gates or physical structures.
- Volume of goods for each delivery point is known and each drop has a location for which there is an established driving time to and from the warehouse or to the next delivery point.
- The quantity of goods delivered to any drop is smaller than the vehicle's carrying capacity and there is an established time to deliver/collect at the drop point.
- The operating hours of the delivery/offloading points are known, and constraints such as peak hours are understood.

### Calculating a Route Plan

A vehicle route is scheduled by basic following steps:

- Establish the time it takes for a vehicle to travel from the origin to a delivery point, adding the time taken to offload at the delivery point, assuming the vehicle is not over capacity or operating at unsafe speeds.
- Establish geographic proximity from the first delivery point to the second (if more than one delivery), counting total time to arrive and any offloading time, also assuming the vehicle is not overloaded or travelling at unsafe speeds.
- Repeat for all desired delivery points.

Continue this set of assumptions for all delivery points needed – once the theoretical vehicle is either too full to carry all deliveries, or the vehicle cannot complete all deliveries during safe and normal hours of operation, then you have established a route plan that fully utilises the available driver's time or the vehicle capacity. Repeat this step for as many vehicles until all orders are allocated or all available vehicles are fully loaded. When calculating the driving time it is important to use an average speed relative to the vehicle type, quality and condition of the roads, and prevailing weather conditions allowing for such things as delays at junctions, hills and urban congestion. In practice, average speed will be considerably less than the maximum permitted speed for a road.

The nature of the movement can be split into two basic types:

- **Primary Movement** - Involve typically bulk movements between two specific locations. This may be between two warehouses in a network or from a port or rail-head to a warehouse.
- **Secondary Distribution** - Movements that may involve multiple deliveries within a defined area, such as a regional or local warehouse to extended delivery points.

In both cases, the emphasis is on achieving full utilisation of the resources used - filling the vehicle to capacity minimising the distance travelled and optimising the hours which the driver is being paid to work.

### Safety and Security

There are a number of safety considerations when planning and managing road cargo, these

might include:

**Load Securing** – Ideally, cargo will be properly secured. A secured load does not just mean sealed to prevent theft, but also to prevent cargo from falling off, or worse, vehicles tipping over and causing accidents. Hard sided box trucks should be properly locked, while intermodal containers may be officially sealed depending on the delivery terms. Cargo stored on flat bed trucks or trailer should be properly tied down and covered. At minimum, cargo should not move around inside or on the truck surface as the vehicle moves, and there should be no spillage or falling items on the road causing hazards for people and other drivers. Local regulations might also govern things such as the vehicle weight, the way it is loaded and how the load is distributed.

**Loader/Porter Safety** - The process of loading and offloading trucks can be very dangerous. Flatbed, box or drop side vehicles may be loaded with the assistance of machinery such as forklifts or small cranes, both of which may move excessively heavy loads that can fall and injure bystanders. The area around trucks loaded with MHE should be cleared of unnecessary personnel, and any designated persons should be clearly marked with high visibility vests.

In humanitarian field settings, vehicles are often loaded by hand, frequently by low skilled labour. Porters should be able to safely and ergonomically load cargo onto vehicles:

- Porters should not carry cargo of excessive bulkiness or weight.
- If the loading point does not have a drive up loading bay, porters should be able to safely step up and down from the vehicle bed without jumping or climbing.
- Porters should only be expected to load for reasonable amounts of time, with breaks in between. Ideally loading teams would be split; 2-4 loaders on the truck and the necessary number of loaders carrying goods to and from the warehouse/depot/discharge point, reducing the need to enter or exit the vehicle.
- Porters should be monitored for unsafe behaviour or possible security concerns.

**Road Conditions** – In many humanitarian contexts, road conditions are extremely poor. Vehicles should be well maintained as possible, and drivers should not take unnecessary risks. Trucking on poor road conditions such as mud, loose soil or standing water can be augmented by the use of 6x6 trucks (3 axle vehicles will all wheel drive) or any vehicle with a drive shaft that powers the rear axles. Drivers should also understand the route, and have some experience navigating adverse driving conditions.

**Infrastructure** – In the immediate aftermath of a rapid onset emergency, or as a result of armed conflict, infrastructure such as roads and bridges may be fully or partially damaged. Routes that may have been previously accessible may be inaccessible. Third-party transport companies and hired drivers should exercise caution around damaged infrastructure.

**Transporting Dangerous Goods** - Vehicles transporting any amount of dangerous goods (DG) for any reason should reference guidance on the [road transport of DG](#) in the Dangerous Goods section of this guide.

**Vehicle Marking** – Depending on the context, there may be national and local laws that require vehicles containing specialty items such as livestock or any form of DG items to be properly labelled and marked while on the road.

**Driver Behaviour** – Drivers and operators of vehicles are responsible for using a vehicle on the road with a safe and secure load. Local laws will often state that the drivers in transit have full responsibility for the safety of their load, even if they did not load it personally. Even in countries or local contexts where such laws are present but are not implemented, respected or

followed, every effort must be made to ensure that the organisation's drivers are following the regulations that have been established. Most humanitarian organisations also have their own safety and security policies that need to be followed.

**In-transit Theft** – The main sources of vehicle theft are from depots, from overnight parking areas and from the roadside. Theft can be committed by stealing an unattended vehicle, forcibly hi-jacking a vehicle, or bribing drivers. Drivers are central to prevention of this type of loss, and their integrity is essential. Consequently, careful recruitment and selection of drivers is critical. Training will impress upon them the need for care, and procedures to follow to avoid risk of theft. Driver identification cards can be used for added security and to avoid thieves gaining access to vehicles by misrepresentation when parked on third party premises. However, there is little to prevent deliberate collusion by drivers. Vigilance is essential and attention to any pattern of discrepancies on loads. A thief intending to steal a loaded vehicle benefits from:

- Knowledge of an attractive load.
- The opportunity to access it.
- Time to steal it and to get away before detection.
- A market for the goods.
- Limited or negligible perception of risk.

## Vehicle Recovery

In the process of movement by vehicles in austere working conditions, vehicles can and will break down, become stuck, or otherwise be immobilised. Understanding the types of equipment and techniques used to recover vehicles is important to drivers and persons planning routes, while knowing the route and type of vehicle in use will help inform the type of recovery tools. Some recovery tools are extremely dangerous when in use, and should be operated only by knowledgeable persons with proper training! Some of the below recovery items are useful for recovering light vehicles only. Heavy vehicles exceeding 7-10 ton capacity may require additional special assistance.

**Scissor/Bottle Jack** – Scissor or bottle jacks are regular vehicle jacks that might be part of the standard package of tools that new cars come with. Scissor or bottle jacks are useful for changing single tires, but are really only best suited for flat, stable road conditions. Scissor/bottle jacks may not work well in mud, and can really only be used to elevate the vehicle enough to change a single tire. On non-paved roads, they may require a solid object underneath them to distribute the weight, such as a flat rock or a strong board. Scissor/Bottle jacks should only be used on the appropriate contact points to avoid causing damage to the vehicle.

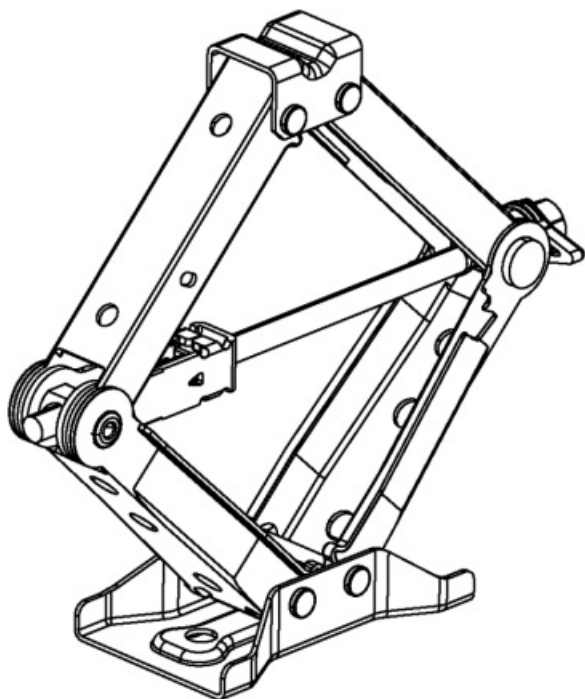

**High-lift Jack** – High-lift jacks are far more robust than scissor/bottle jacks. They can be used to lift vehicles out of mud, or raise vehicles enough to place braces or other objects underneath them. When a vehicle is full lifted, a supporting high-lift jack can have enormous pressure on it; the jack handle if not properly secured can cause bodily harm, and the jack itself may collapse with the full weight of the elevated vehicle. High-lift jacks should only be used on the appropriate contact points to avoid causing damage to the vehicle.

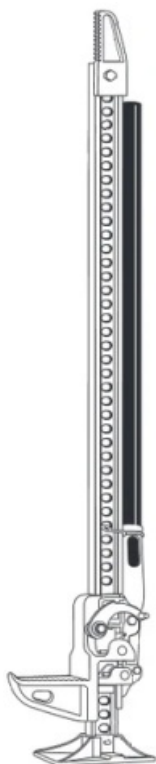

**Recovery Winch** – Recovery winches are powered electric motors that can retract rope or metal

cable. Many field level vehicles have winches permanently attached to the vehicle, usually on the front bumpers. Winches usually draw their power from the electric battery of the vehicle, and are capable of supporting the weight of the vehicle itself. Winches should only be attached to objects and anchor points that can physically support the weight of the vehicle and withstand the horizontal pressure applied by the winch. When a winch is being used, all persons should be inside a vehicle, have proper cover or be a safe distance away.

Winches are useful for pulling vehicles stuck in mud, or are otherwise immobilised on an incline. Because winches are made to support the full weight of a vehicle, the cables or ropes can be very dangerous under full pressure. Additionally, improper use of a winch may cause damage to vegetation or nearby structures. Sometimes, vehicles with winches utilise what are called "snatch blocks" or "winch blocks" – pulleys that are designed to change the direct anchor point of a winch when a clean anchor isn't available.

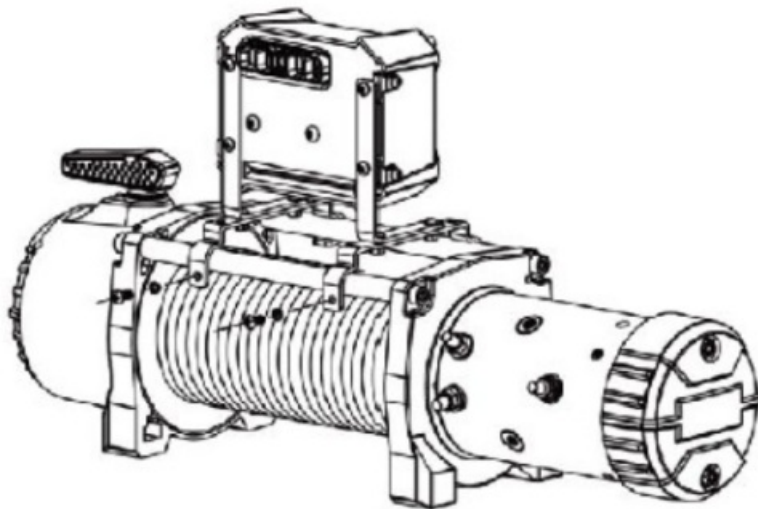

**Snatch Straps** – Snatch straps are bands made of durable synthetic material that are designed for one vehicle to pull another vehicle. Snatch straps should be strong enough to support the weight of the vehicle being towed, with some additional tension caused by momentary velocity differences between the vehicle being towed and the vehicle pulling. Snatch straps should only be used in a slow-speed, and only in a recovery capacity. Much like the winching, snatch straps should only be in use when all persons are at a safe distance.



Other tools that may be useful for vehicle of all size include:

- Tire irons
- Full sized spare tires
- External air compressors
- First aid kits
- Jumper cables

## **Cargo Configuration for Road Shipping**

### **Loading Vehicles**

Unlike sea or air cargo transportation, humanitarian actors will almost certainly be involved with the direct loading of cargo vehicles at some point. Loading of cargo onto a truck may appear fairly straight forward, however there are several things that shippers may need to consider. Frequently, third-party transport companies and private vehicle hires may understand the loading needs of their own vehicles, but in the event agencies are self-managing loading or the third-party service does not have the capacity to manage loading, organisations may have to - and possibly be legally required to - take responsibility for securely loading vehicles.

The overall balance of the load on the bed or cargo hold of any truck varies based on the body, while the overall weight limits of each of the vehicles varies based on the vehicle itself - prior to planning a cargo load, it is strongly advised to research the type of vehicle to avoid accidents.

Single unit or conventional trucks are designed to carry 70-80% of cargo weight over the rear axle, balancing the load of the cargo against the weight of the cab.

**Cab Over Engine Truck**

**Conventional Truck**

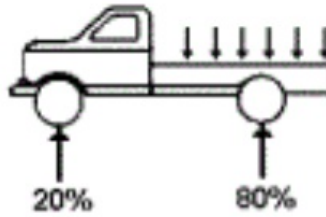
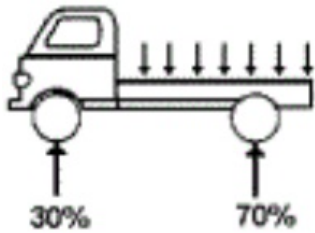

When loading cab over engine or conventional pickup trucks with heavy cargo loads, start above the rear axle with weight distributed just before the axle towards the centre of the bed. Loads pushed too close to the cab can obscure the rear view of the driver, will increase the distance required to break, and may reduce traction to the road due to uneven weight distribution. Loads pushed too far to the rear will be more unstable and can also cause problems with traction. Loads sticking far off the rear of a smaller truck should be avoided whenever possible – excessively long loads not only cause weight imbalance to the vehicle, but may be hazardous to other vehicles and passengers.

**Correct Loading**

**Incorrect Loading**

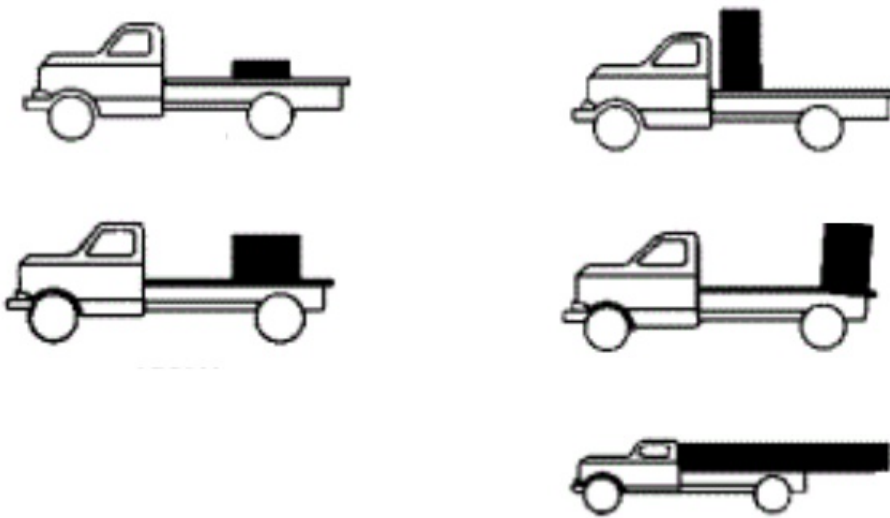

Tractor / trailer configuration trucks are designed to keep cargo weight centred between the two axles. When loaded to a tractor weight should be evenly distributed in the centre of the bed, while trailers without a truck may be loaded with weight slightly moved towards the rear axle.

## Trailer and Tractor Trailer Truck

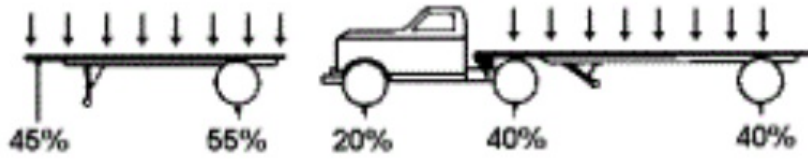

When planning a load on a trailer, consider the "X" planning strategy - if a line is drawn between each of the wheels where they make contact with the road, where the two lines intersect to form an "X" is where the centre of gravity for any cargo load should go.

"X" configuration:

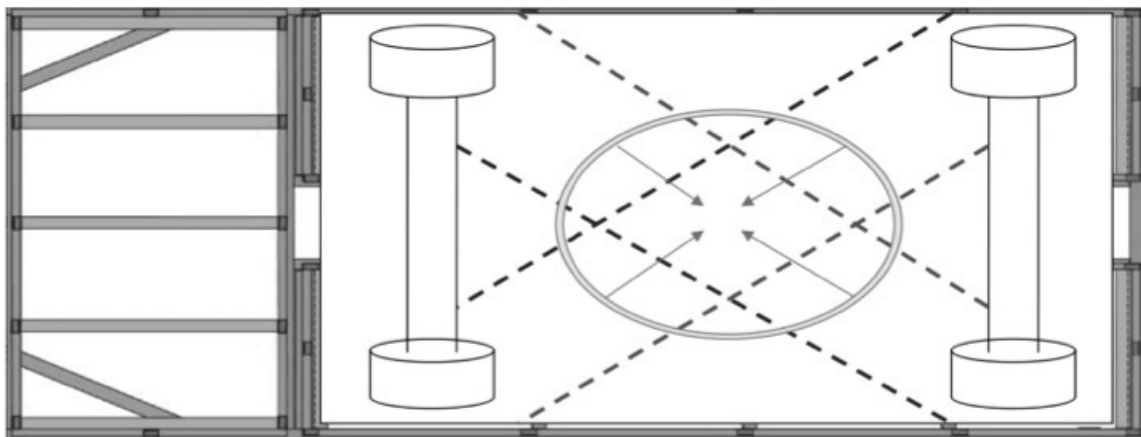

**Correct Loading**

**Incorrect Loading**



**Correct Loading**

**Incorrect Loading**

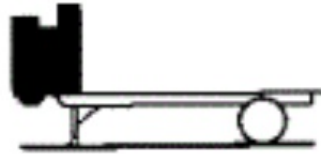
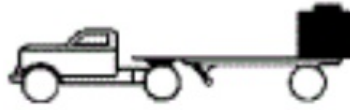

When loading all vehicle types, ensure that cargo weight is also centred in along the short edge of the bed as well. Cargo weight too far to one side or another can lead to instability in the vehicle, impacting turning or even leading to vehicles tipping over.

**Correct Loading**

**Incorrect Loading**



In all loading configurations, planners and loaders should consider:

- Always load the heaviest items at the bottom of the items stacked onto a truck bed. Top heavy loads are more likely to fall over in transit.
- Loaders should plan for weight to be evenly distributed on all four sides of a truck bed. Even if space is properly utilised, overly heavy cargo on one side of the vehicle will cause

issues while in transit.

## Weight in Movement

Cargo on the back of a vehicle can be heavy or bulky, and while drivers may understand the overall weight of the vehicle while stopped or at low speeds, increased speed can cause the weight of the cargo to act on the vehicle in unintended ways. Forces acting on the cargo during transport are caused by different movements made by the vehicle. The acting forces are:

- Deceleration
- Acceleration
- Centrifugal force (outward)
- Gravity
- Vibration

These forces may cause sliding, tipping and wandering. Cargo loads should always be properly secured, and vehicles should take extra caution when going around corners, going over bumps or small hills, or when starting or stopping.

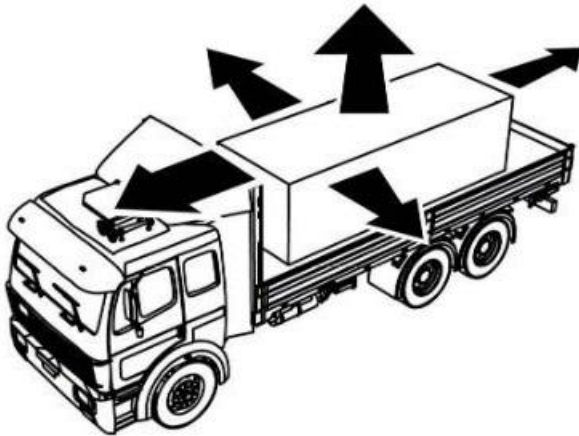

## Cargo Tie-Downs

Any place where a rope or chain passed over cargo and is secured to both sides of the vehicle is referred to as tie-down.

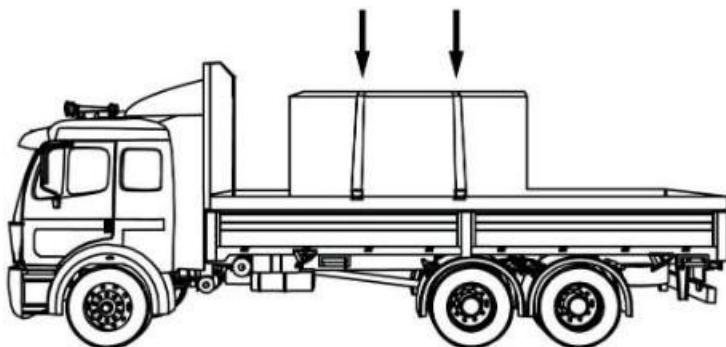

A general guide for how many tie-downs to use can be seen below:

<b>Number of Tie-Downs</b>	<b>Length of Load</b>	<b>Weight of Load</b>
<b>1</b>	Shorter than 1.5 meters	Less than 500 kg
<b>2</b>	Shorter than 1.5 meters	Greater than 500 kg
<b>2</b>	Longer than 1.5 meters but shorter than 3 meters	-
<b>3</b>	Longer than 3 meters but shorter than 6 meters	-
<b>4</b>	Longer than 6 meters but shorter than 9 meters	-
<b>4 (at least)</b>	-	Greater than 4,500
<b>5+</b>	Additional tie-down for every additional 3 meters gained after 9 meters	

Typical loads of cartons and basic relief supplies can be secured using nylon rope, however extremely heavy equipment such as generators or vehicle should be secured using chains. The best way to gauge the strength of a series of chain tie downs to secure a load is what is known as the “working load limit” (WLL). WLL is measured by combining the WLL of each individual chain or rope used as a tie down. As an example, if a load is secured with four chains with a WLL each of 500 kgs, the TOTAL WLL for that load is 2,000 kgs.

To properly design a WLL for transport of heavy or bulky cargo, the total WLL of all tie-downs should be at least half the weight of the load itself. As an example, if a truck is transporting a generator that weighs 3,000 kgs, the combined WLL of all the securing chains should be at least 1,500 kgs. The WLL on the tie-downs accommodates for shifts in weight as the truck turns, stops or accelerates, shifting the centre of gravity of the heavy load.

Chains are measured in both their size and their grade:

- Size - The diameter of the metal "wire" in the link.
- Grade - The stress a chain is designed to break at.

A general guide to WLL per chain type can be seen below.

#### **Working Load Limit (WLL) in Kilograms (kgs) per Grade and Chain Size**

Chain Size (cm)	Grade 30	Grade 43	Grade 70	Grade 80	Grade 100
0.6	500	1,100	1,400	1,500	1,850

### Working Load Limit (WLL) in Kilograms (kgs) per Grade and Chain Size

0.8	900	1,800	2,200	2,100	2,600
0.95	1,200	2,550	3,000	3,200	4,000
1.1	1,600	3,200	3,900	-	-
1.25	1,900	4,000	5,000	5,400	6,700
1.6	3,150	5,900	7,200	8,250	10,300

Whether shipping cartons or oversized bulky items, there are recognised loading and securing methods to minimise accidents and damage to cargo.

**Cartons / sacks** – when loading cartons or sacks into the bed of a truck, avoid stacking in pyramid or forming piles. Cartons and sacks should be stacked in even rows, as low to the bed of the truck as possible. Stacks should be arranged in [interlocking "brick" format](#) to avoid stacks from coming apart, and where possible, stacks of cartons or sacks should be secured with netting, tarp or rope, especially if the truck bed has no sides or bars.



**Bulky items** – bulky items such as timber, generators, or other large equipment should be firmly secured to bed of a truck using rope or chain of appropriate strength.

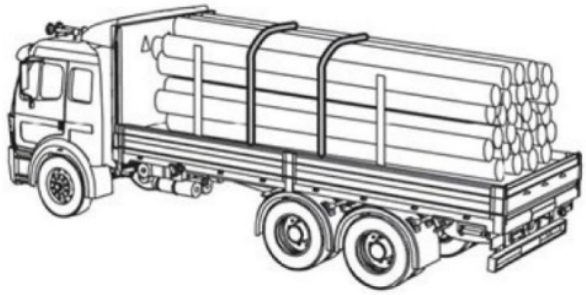
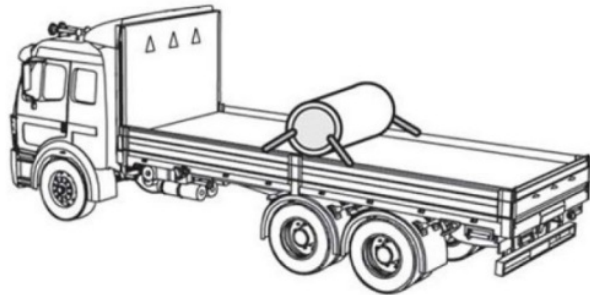
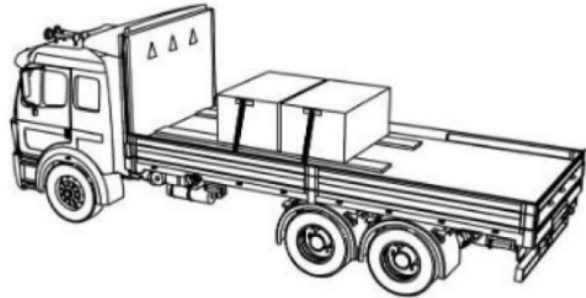
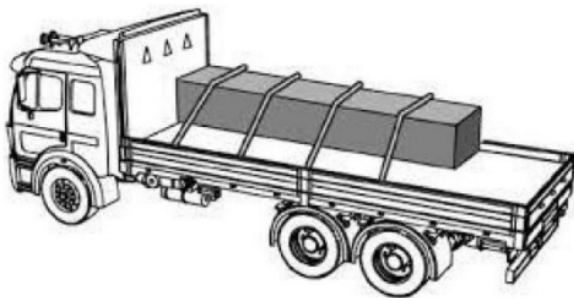

A quick reference guide to cargo load securing can be [downloaded here](#).

## Contracting Third-Party Transport

## Recommended Terms - All Movements

If humanitarian organisations plan to solicit and contract third-party transport services, below is a general guide to terms and conditions that planners may wish to consider.

- The contracted trucking company should ensure that drivers fill in all required information on provided logbooks or activities sheets as instructed and agreed with the contracting agency.
- It is recommended that the contracted trucking company should ensure a proper and adequate [vehicle inspection checklist](#) is completed daily.
- The contracted trucking company should ensure all trucks have adequate lashing or tie down equipment, and all required handling equipment.
- The contracted trucking company should ensure that all drivers wear safety equipment present in the truck for driver use as and when required.
- It is recommended that humanitarian agencies require contracted trucking companies to use [logbooks](#), activity sheets and [vehicle inspection checklists](#), maintained for all drivers / equipment for quality assurance purposes. Contracting humanitarian agencies should inspect logbooks and activity sheets on a routine basis.
- Where possible, drivers should be reachable during the whole transportation time by the contracted trucking company and contracting humanitarian agency whenever needed.

### Driver Training

- The contracted trucking company should ensure the driver used for transporting humanitarian goods is well trained, and training can be demonstrated to contracting humanitarian agencies upon request.
- The contracted transport company should ensure that the drivers used for delivering pharmaceuticals or other temperature sensitive goods are trained well and are aware of the temperature requirement of the goods being carried.
- The contracted transport company should ensure that the drivers used for delivery dangerous goods are well trained on handling and transport of dangerous items, and in compliance with national and local laws and regulations.

### Contracted Trucking Company Responsibilities

- If any truck is subcontracted by contracted trucking company, the subcontracted vehicle is the contracted trucking company's sole responsibility and should ensure the subcontractors comply with the conditions agreed between the humanitarian organisation & contracted trucking company.
- The contracted trucking company is responsible for ensuring that all cargo is delivered within the agreed transit time period.
- The contracted trucking company should ensure the drivers reach the correct point of delivery and the proof of delivery has to be signed and stamped by the consignee.
- The contracted trucking company should ensure to handover of cargos at point of delivery.
- The contracted trucking company should submit invoice, and receipts to the contracting humanitarian agency within the pre-defined contracted period after delivery.

### Reports and Communications

- The contracted trucking company should clearly communicate the daily transportation requirements.

- The contracted trucking company should ensure that if drivers are not reachable, a status update report can be sent once the drivers are contacted. Update reports should be sent at a pre-defined period, established in the contract.
- The driver used for any transport should report any instance of the following within a contractually pre-defined period:
  - Accident, theft, or damage at any point during the transportation.
  - Security incidents, including checkpoints, detention, armed conflict on the road, harassment from security officials or any other security related matter.
  - Physical impediments including damaged infrastructure, road closures, impassable weather conditions, or anything else that may prevent vehicle movement.
- Any additional charges billed without transport supervisor / manager awareness should not be accepted and should be removed from any invoice or 'statement of account' of the contracted trucking company.
- The contracted trucking company should promptly inform the contracting humanitarian agency via phone or email in any case of discrepancy at the destination offloading point, such as short shipment, damages, theft, temperature variances or any other problem related to delays in delivering the cargo to the point of delivery.

### **Insurance and Limitations of Liabilities**

- The replacement costs of lost or damage of transported items due to negligence should be the responsibility of the contracted transport company, and all repayment terms and deadlines should be included in the contract between parties.
- The contracted trucking company should indemnify the contracting humanitarian organisation, its affiliates and its and its and their officers, and employees from and against all claims, liabilities, damages, and expenses arising out of or incidental to the performance of the services, for:
  - Any and all injuries to or death or illnesses of any person.
  - Any and all damage to or loss of property.
  - Any and all damage to or loss of humanitarian organisation's goods under the sole care, custody and control of contracted trucking company in the performance of the services.
  - Any and all breaches of applicable laws and regulations, except in cases of gross negligence or wilful misconduct of the contracting humanitarian organisation.
- It is strongly recommended that the contracted trucking company should be obliged to take out and maintain, in its own name and at its own expense insurance adequate to cover its liabilities in full force and effect at all times during the contracted transport process:
  - Liability insurance policy to cover any and all shortages, damages, pilferage, missing, misallocation or any other loss of the goods while in the contracted trucking company's care, custody or control subject to a maximum liability of an adequate amount to compensate the contracting humanitarian agency against any loss or goods damage in accordance to the applicable local laws and regulations; whichever is higher.
  - Motor third party liability insurance, with minimum compensation limits for bodily injury, death or property damage in accordance to local applicable law and regulations
- All insurance policies effected by the contracted trucking company should contain the provision that they cannot not be amended, deleted or permitted to lapse without the express prior approval of the contracted company.
- Deductibles under the insurances maintained by the contracted trucking company or its subcontractor should be the responsibility of contracted trucking company's or its

subcontractor's.

## **Recommended Terms - Temperature Controlled Movements / Requirements**

For more information on contracting third party transporters to move temperature regulated medical cargo, please reference the [health supply chain](#) section of this guide.

## **Organising Humanitarian Convoys**

In the course of humanitarian operations, humanitarian aid agencies may need to organise convoys for the proper delivery of relief items. The need to organise a convoy may be very contextually dependent - in well developed markets with high degrees of road safety and predictability, there may be no reason to use convoys at all. The use of convoys is usually based upon the insecurity of the operating environment, the uncertainty of the road conditions, the absence of persistent communications along the route, the value of the cargo, or any combination therein. General guidelines for organising convoys may be as follows:

### **Operational Basics**

- Though the decision is ultimately up to each humanitarian organisation's management, it is strongly advisable that vehicles should not be part of military convoys, or even civilian humanitarian convoys with armed escorts.
- Radio/telephone/communications contact should be kept between at least the vehicle at the back of the convoy and the leader.
- Where possible, vehicles should carry communications equipment capable of reaching a location or focal point in a different location.
- Planned convoy dates and contents should not be shared widely, or with unauthorised parties.
- Local communities, police, military or governments may have procedures for organising convoys, or for passing through specific areas. Humanitarian organisations should liaise with proper authority figures before moving through unknown areas.
- Humanitarian agencies may choose to operate their own convoys, or collaborate to form joint convoys. If more than one organisation is participating in a convoy, all parties should agree to and understand on rules in advance, and even develop written agreements in necessary.
- Agencies may use commercial vehicles, or they may utilise their own leased/owned vehicles. The policies and rules in place for convoys should reflect the transport arrangement. If commercial transporters are used in a convoy, terms of the convoy may need to be written into transporter contracts.
- The person/team on the receiving end of a convoy should ideally be informed in advance of what the anticipated cargo is, and if possible should receive an advanced copy of the packing list, and receive estimated dates/times of arrival. All cargo should be counted - and if required weighed/measured - at the receiving end to ensure no cargo has gone missing along the way.

In the event of a cross-border operation:

- All customs related documentation should be identified and provided in advance to the driver, convoy leader, and intended recipient.
- A trustworthy person from the organising humanitarian agency should inspect cargo and vehicles both prior to arriving at the border crossing and after goods are cleared to

- ensure that cargo has not been tampered with and avoid accusation of smuggling.
- If cargo is offloaded and transloaded onto new vehicles, a representative from the organising humanitarian agency should be present to observe the process. Ideally, cargo should be counted after the transloading is complete to ensure that no theft or loss has occurred.
  - Organisers should plan for border crossing times.
    - Vehicles may wait for days or even weeks at border crossings in some cases. Drivers must have the ability to eat and sleep safely while still maintaining physical presence around cargo vehicles.
    - Ideally, vehicles should be able to return safely in daylight hours if rejected at the border.
    - Any and all delays or problems associated with customs or border crossing should be communicated to the appointed organising focal point as soon as possible.

## **Convoy Organisers**

It is strongly advised that convoy organisers should:

- Appoint a convoy leader with experience and knowledge of the route.
- Where possible, plan the route carefully in advance with designated stopping places.
- Generate and provide all required documentation, including waybills and packing lists.
- Decide beforehand what procedures to follow if the convoy is obstructed or blocked, and brief all drivers fully before starting movement.
- Identify a security focal point and/or organiser outside the convoy who will be on call during convoy.
- Conduct detailed briefings with transporters/drivers.
- Ensure they have driver names, contact details, and vehicle plate/registration numbers prior to departure.
- Maintain communication with convoy leaders at pre-determined intervals where possible.
- Following each trip, record any security incidents or checkpoints for future planning.
- Develop a repair and recovery plan (spare parts, a chase vehicle, easy access to a recovery vehicle, etc.).
- Recover visibility items once the mission has been completed, especially in cases where commercial vehicles are in use.

## **Convoy Vehicles**

Before a convoy departs, it is strongly advised that vehicles should:

- Be in a good mechanical condition. Organisations and planners should check for significant wear and tear, tyre pressure, etc.
- Travel with a full complement of spare parts (filters, belts, spare tires, motor oil, etc.) wherever possible.
- Where necessary, be well branded with their organisation logos. It is suggested to use at least one of the following items: flags, banners or large stickers.
- Be fully fuelled and ready to depart upon reaching the assembly point.
- It is strongly advised that vehicles have an alternate driver. The driver's alternate should be legally able to drive, and have experience with long-haul trucking.

During a convoy, it is strongly advised vehicles should:

- Obey speed limits, and drive only as fast as conditions permit.
- Obey all local and national rules and regulations.



- Maintain a steady speed.
- Not overtake other vehicles within the convoy.
- If required, use flags to distinguish the first and last vehicle of each section.
- Maintain a constant distance between each other. The recommended distance is 100 meters in day, 50 at night, however distance between vehicles will depend on terrain, the speed required, visibility, and other limiting conditions.
- Not transport any cargo that is not contained on the associated waybills/packing lists, not part of the originally delivery plan, and that is not intended for humanitarian use.
- Where avoidable, not move in convoy before sunrise and/or after sunset.
- Abandon the convoy or leave any truck behind without instruction from the convoy leader or authorised person.
- Not pick up hitch hikers or other persons not originally in the convoy plan. Vehicles should be especially warned against transporting soldiers or non-state armed actors under any circumstances.

In the event a vehicle breaks down while in transit:

- All convoy vehicles must stop. The convoy leader should contact the designated organiser and security focal point.
- Convoys should resume only after it is determined that a repair/recovery effort is underway, or if the security focal point determines that it is safe to leave a vehicle behind.

## Convoy Drivers

As a general guide, convoy drivers should:

- Not carry or transport any form of weapons, narcotics, and/or spirits.
- Not depart without the authorisation of the convoy leader and/or authorised convoy organiser.
- Not hand over any fuel or communication equipment, money, or cargo contents to any persons on the road unless they are part of a planned delivery/distribution process.
- Not participate in any inappropriate behaviour (including but not limited to, any form of intoxication, harassment, sexual harassment, abuse of power). Appropriate behaviour of convoy personnel should be mandatory.
- Drivers must carry all the necessary legal documentation clearing them to drive in the areas of operation.

Title

Download - Convoy Planning Template

File



## Rail Transport

Compared to other forms of cargo transportation, rail transport is quite safe. Rail transportation is capable of high levels of passenger and cargo movement while maintaining energy efficiency, but is often less flexible. Rail transport costs less than air or road transport, making it extremely cost effective for inland movement.

## Common Terms in Rail Transport

<b>Railcar</b>	Any type of pre-made container designed for transportation of goods using rail locomotion. Railcars are unpowered, and require an engine to push or pull them. There are a variety of rail cars designed to accommodate a variety of shipping needs.
<b>Engine</b>	Powered vehicle that is operated by a pilot and is used to push or pull railcars over long distances. Engines can be electric, or powered by fossil fuels.
<b>Full Carload</b>	A volume of cargo that is capable of filling an entire rail car.
<b>Less Than Carload</b>	A volume of cargo that is less the volume required to fill an entire railcar.
<b>Railyard</b>	A large open area alongside train tracks where trains can be domiciled or repaired. Railyards are also where cargo loading and offloading operations occur.
<b>Heavy Haul</b>	Train cargo that is considered bulk or full cargo, as opposed to passenger rail vehicles or light rail (usually inner city public transport).
<b>Interchange</b>	The act of switching cars between one train and another.

## Rail Transport Arrangements

**Containerisation** – much like sea freight, many railways can accommodate containerised cargo. There are no differences between the [containers used in sea shipping](#) and those use in rail shipping. The process of stuffing and sealing containers may occur at the shippers facility, or may occur at a consolidation point or forwarders facility. The same volume and weight restrictions apply to rail shipping using containerisation as they do to sea shipping.

**Loose Shipping** – shippers may wish to ship less than full rail car loads using rail, or may not have access to intermodal container shipping through the desired rail line. Cargo can still be shipped using a variety of rail cars. Sending palletised or loose cargo via rail is similar to sending cargo with a third-party trucking company – cargo will be loaded onto the train utilising pre-made and usually hard sided structures, and will be offloaded on the receiving end. Usually, shippers aren't even allowed into the rail yard to participate in the loading/offloading of rail cars, and will only see cargo as it's picked up outside the railyard, or once it's delivered to their facility. Securing shipping for loose cargo via rail can be done through any freight forwarder or broker, and rail lines may even have direct customer service.

## Unique Concepts to Rail Transportation

**Infrastructure Limitations** - Rail transportation has a far limited scope compared to most other forms of cargo movement. The reality is rail movement needs specialised built out infrastructure – a rail network – that requires maintenance and is easily damaged by weather or conflict. Shippers utilising rail to move cargo have very few options – the size of railcars is limited by the overall size of the tracks, and freight trains have a fairly limited set of destinations. In many contexts where many aid agencies work and operate, there will likely not

be a functioning rail network all together.

**Inflexibility** - Rail is very suitable for the movement of large load sizes over longer distances, but it lacks the versatility and flexibility of motor carriers since it operates on fixed track facilities. Rail can only provide services terminal to terminal, rather than point to point delivery services offered by trucking. Though rail transport offers an effective method of bulk haulage, it can be very slow, especially considering loading, offloading, and overall railyard operations.

## **Sending Cargo by Rail**

### **Rail Transport Documentation**

**Rail Waybill / Freight Waybill** - Documentation for movement by rail is controlled through the rail waybill. Unlike a BOL, CMR or AWB, the rail waybill is a nonstandard, non fixed-format document. Rail waybills are typically created by and supplied by the rail line, and will contain locally relevant and important information.

The rail waybill is a non-negotiable document containing the instructions to the railway company for handling, dispatching and delivering the consignment. No other document is required for domestic shipments, however shippers may wish to include additional information such as a detailed packing lists. For international transport across borders, shippers should be made locally as to the proper documentation needed.

Example Rail / Freight Waybill:

PLACE SPECIAL SERVICE PASTERS  
HERE

**FREIGHT WAYBILL**

TO BE USED FOR SINGLE CONSIGNMENTS, CARLOAD AND LESS CARLOAD

CAR INITIALS AND NUMBER		KIND	LENGTH/CAPACITY OF CAR	
			ORDERED	FURNISHED
STOP THIS CAR AT			CONSIGNEE AND ADDRESS AT STOP	
TO STATION			FROM	STATION
ROUTE			SHIPPER	
RECONSIGNEED TO STATION			AMOUNT	WEIGHED
CONSIGNEE AND ADDRESS			C. \$	AT
			O. \$	GROSS
<small>WHEN SHIPPER IN THE UNITED STATES EXECUTES THE NO-RECOURSE CLAUSE OF SECTION 7 OF THE BILL OF LADING, INSERT "YES".</small> <small>Indicate by symbol in Column provided * how weights were obtained for L. C. L. Shipments only. R—Railroad Scale. S—Shipper's Tested Weights. E—Estimated—Weigh and Correct. T—Tariff Classification or Minimum.</small>			D. \$	TARE
			PICKUP SERVICE	ALLOWANCE
ON C.L. TRAFFIC-INSTRUCTIONS			DELIVERY SERVICE	NET
			RECEIVED	IF CHARGES ARE TO BE PREPAID, WRITE OR STAMP HERE "TO BE PREPAID."
			ON L.C.L TRAFFIC TRANSFER STAMPS	
NO. PKGS.	DESCRIPTION OF ARTICLES	*	WEIGHT	

## Cargo Configuration for Rail Shipping

If not utilising intermodal shipping containers, shippers generally have very little control over how cargo is loaded, nor are there many special considerations while packaging cargo. Cargo may be shipped palletised or loose, however it may be in the best interests of the shipper to palletise and label cargo as much as possible to minimise loss or theft while in transit. Trains can haul heavy and large cargo, and are really only limited by excessively oversized items, such

as oversized construction equipment. Certain routes may be limited by tunnels or underpasses, so shippers should inquire with their forwarders about the overall limitation for shipping using a specific rail line.

The overall types of railcars used for shipping are:

**Box Car** – The most common form of pre-made purpose built rail car. Box cars are sealed on all sides and have hard, rigid structures with locking doors. Box cars need to be manually loaded, similar to the bed of a box truck.

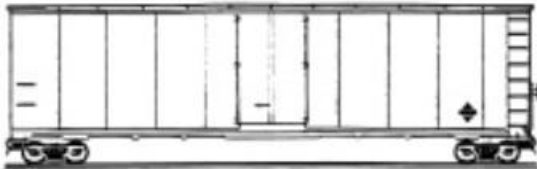

**Flat Car** – A car without hard siding, used to transport wide or tall cargo such as vehicles and construction equipment. Flat cars can also house standard shipping containers. Flat cars can also be used for regular cargo, but would expose regular cargo more to the elements and theft.

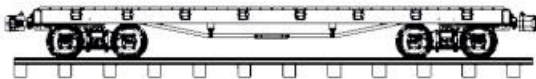

**Hopper Car** – An open top box car with reinforced support under the long edges. Hopper cars are used for hauling large quantities of loose bulk items, such as grain, sand, ore, or anything non liquid that can be dumped directly into the body of the car. Offloading may be done by hand or MHE. Some hopper cars are capable of tilting to rapidly offload bulk cargo at once.

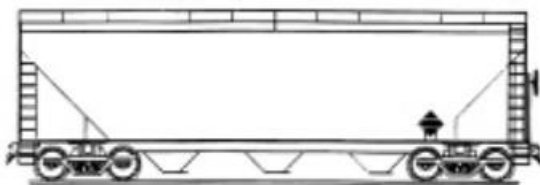

**Tank Car** – Can be low-pressure (liquid) or high-pressure (gas). Ideal for moving large volumes of liquid long distances. There may be restrictions on the liquid and gas types due to national and local laws and limitations on handling hazardous goods.

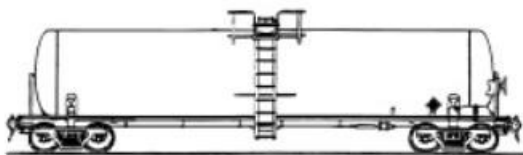

## Inland Waterways and Rivers

Where road and rail transport are not possible due to lack of infrastructure it may be necessary to transport goods by river, delta, marshes, canals or other form of inland waterways. The mode of transport will be informed by the nature of the inland waterway, including depth, water current, necessity for speed of delivery, and ability to load/offload at remote locations and destinations.

## Barges

Under very specific circumstances, barges can be an extremely cost-effective way of moving large volumes of cargo relatively large distances. Barges are wide, flat river vessels with low edges, have flat bottoms, and have a shallow draft. This makes barges ideal for use in calm flat and shallow waters like a river, but largely unsuitable for turbulent waters like the open ocean. Barges can come in two configurations:

**Self-propelled** – Self-propelled barges have a connected cabin and engine mount, and move as a single piece. Usually the engine is designed for moving large loads, but isn't meant for speed.

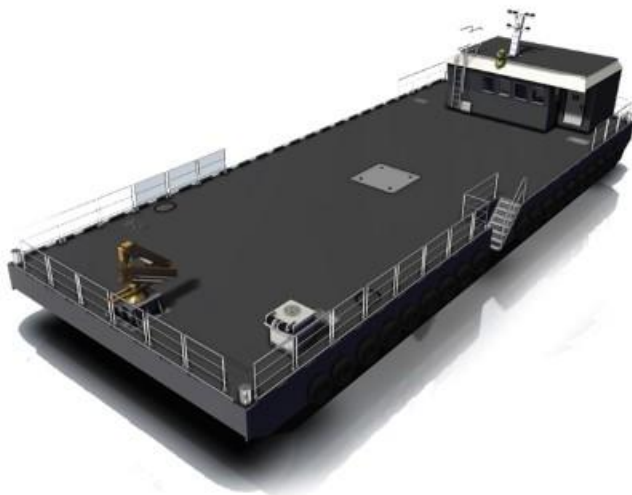

**Dumb Barge** – A “dumb” barge is a non self-powered floating platform, capable of holding cargo, but is without steering or an engine. Dumb barges require an external boat to move, including a tow boat or a “pusher,” a separate motivated boat that is specifically designed to push or pull dumb barges along waterways.

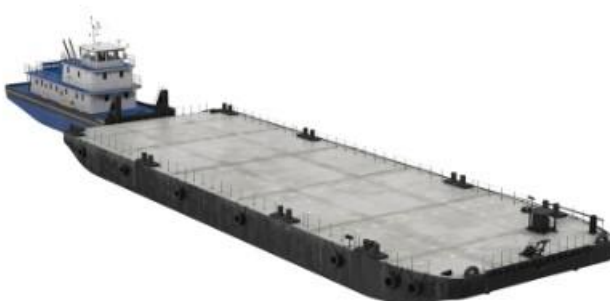

The barges themselves are divided into three general categories:

**Flat Deck** – A barge on which the deck stowage is one large flat surface, upon which cargo rests and is secured to. Flat deck surfaces on barges are very exposed - they won't protect cargo from waves or from turbulent water, and items stored on the surface of flat decks can be easy targets for thieves. All cargo transported on the surface must be properly secured and tied down, and valuable items stored in a manner that won't enable easy theft.



**Hopper / Split Hopper** – A barge with one large or many smaller compartments that are partially below the edge of the barge. Hoppers can be used to store bulk loose items such as grains, sand or ore. Many hoppers can be covered with tarp or hard metal lids to protect contents, and some can even store additional cargo on top of the hopper compartments. Depending on the cargo, hopper/split barges can be loaded by hand or specialised MHE.



**Tanker Barge** - A barge designed to carry liquids or compressed gasses. Tanker barges requires specialised maintenance, and will only be used if the sending and receiving ports have the proper equipment to load and offload.



Barge movement is likely the cheapest mode of moving cargo inland into a country, however it has limitations. Barging operations are extremely slow; the loading and offloading process can take days or weeks depending on the load type and the journey itself can take weeks to accomplish. Barges are also further limited by the ability to safely moor and offload at the point of delivery. Barges themselves can be impacted by seasonal changes to the riverway, making areas impassable for periods of time.

In reality, there are only a few locations globally where barges will be effectively used in a humanitarian response operations. There is no standard form of documentation for utilising barges, and users of barge services will need to supply their own tracking documentation and process their own customs formalities if required to.

## Boats

Inland water ways can be navigated by boats of the appropriate sizes. Smaller boats have the advantage of moving quickly and fitting into smaller water inlets, however will also be limited in the volume of cargo they can carry. Agencies may wish to rent or lease their own boats for rapid response operations.

There may also be large riverway shipping operations on vessels capable of carrying relatively large volumes of cargo. Utilising third-party riverway shipping should be treated the same as utilising any local third-party transport.

## Pack Animals

Any goods being moved via animal must be packaged in relation to the weight that the particular animal can safely and humanely carry. There are many possible variations of available local animals depending on geography, climate, the local economy, and a variety of other local conditions.

A general guide to working limitations of different pack animals might look like:

Animal	Load Capacity	Daily Work Rate	Region
Elephant	500 kg	5-8 hours/walk 24 km	Asia
Donkey	50 kg	Mountain, 8 hours	Middle East, Africa, South Asia, Latin America & Caribbean
Mule	50 kg	Mountain, 8 hours	Middle East, Africa, South Asia, Latin America & Caribbean
Llama	50-80 kg	8-10 hours/walk 30 km	South America
Horse	60 kg	6 hours	Asia, Eastern Europe, Middle East & North Africa
Bull	150-250 kg	8-10 hours	Middle East & North Africa, South Asia
Camel	150-250 kg	Walk 50 km	Middle East & North Africa, South Asia
Yak	70 kgs		South Asia

*Pack animals estimated their work rates - WFP Transport and Logistics Manual*

Speaking with a local expert is strongly advised when developing an animal delivery plan.



Typically, use of pack animals will be negotiated and contracted directly with the owners, or those in control of the animals who will be responsible for the transport. These may include:

- Village elders.
- Local authorities.
- Committees of animal owners.
- Local NGOs.

Transport documents will vary, but a variation of the standard method may be used, possibly amended as follows:

- Issue one waybill for each group.
- Divide the animals into groups under one supervisor.
- List animal owners and number of animals provided by each individual.
- Assign a quantity of consignment to each group, for accountability.

All contracts for carriage by pack animals should still undergo the standard procurement process established by each individual agency, and be within each agencies procurement procedures.

## Cargo Capacity Calculator

**DISCLAIMER:** This calculator is for planning purposes only. Real world conditions can and will dictate the actual loading capacity of vehicles and number of trips required.

- The real uplift capacity of air-craft is contingent on weather, altitude, distance flown, and other factors. Real world conditions will limit total cargo transport capacity. [Read more information here.](#)
  - Volume limitations per truck are purely estimates. Real world transport vehicles, load plans and prevailing laws will have a wide impact on actual volume capacities. [Read more information here.](#)
- 

## Transport Tools and Resources

### Templates and Tools

[Guide - Aircraft Cargo Specifications](#)

[Guide - Container Specifications](#)

[INCOTERMS 2020](#)

[Guide - Vehicle Body Types](#)

[Guide - Correct Cargo Loading](#)

[TEMPLATE - Cargo Manifest \(Flights\)](#)

[TEMPLATE - Packing List](#)

[TEMPLATE - Proforma Invoice](#)

[TEMPLATE - Waybill](#)